

Secotom-15

Instruction Manual



Manual No.: 15997025
Revision B

Date of Release 2018.11.19

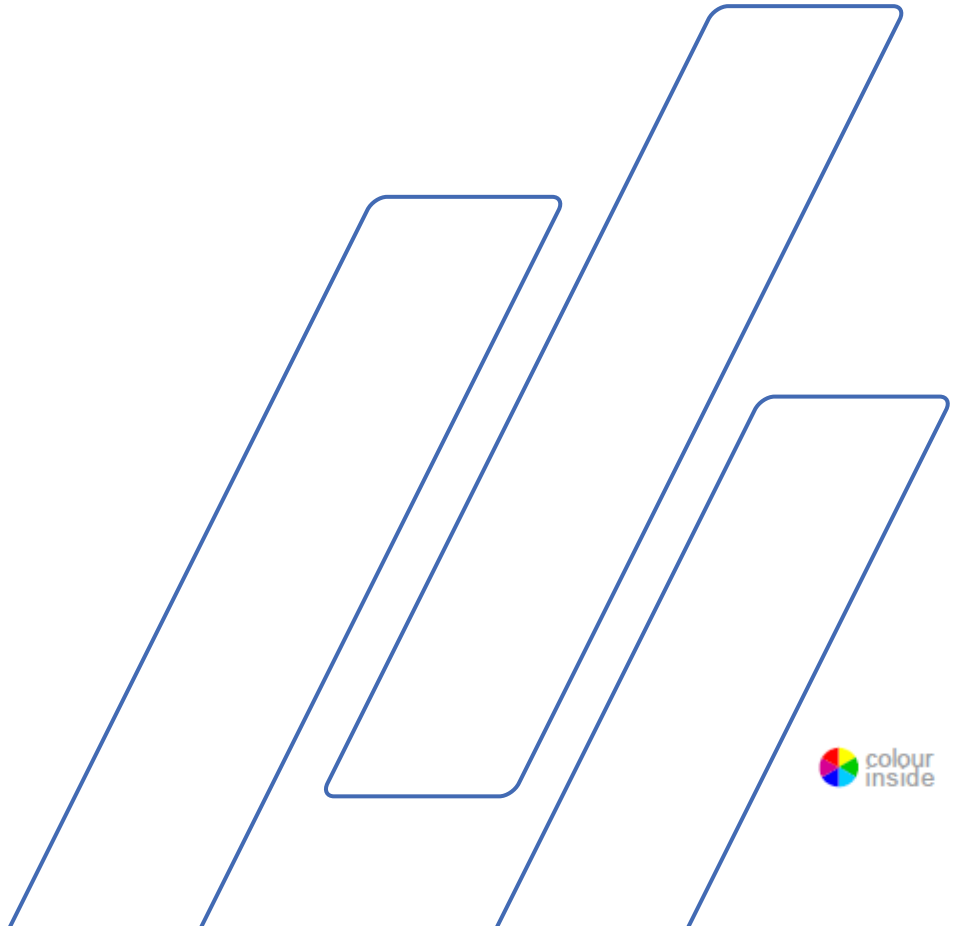

Table of Contents	Page
Intended use	3
Safety Precaution Sheet	5
Icons and Typography	7
User's Guide	9
Reference Guide	55
Appendix:	
Pre-Installation Checklist.....	78
Contents of the Declaration of Conformity.....	85

Intended use

For professional, automatic materialographic cutting of materials for further materialographic inspection. The machine is only to be operated by skilled/trained personnel. The machine is only designed to be used with Struers consumables specially designed for this purpose and this type of machine.

The machine is for use in a professional working environment (e.g. a materialographic laboratory).

Do not use the machine for:

Cutting of materials other than solid materials, suitable for materialographic studies. In particular, the machine must not be used for any type of explosive and/or flammable material, or materials which are not stable during machining, heating or pressure.

Model:

Secotom-15



NOTE:

READ the instruction manual carefully before use.

Keep a copy of the manual in an easy-to-access place for future reference.

Always state *Serial No* and *Voltage/frequency* if you have technical questions or when ordering spare parts. You will find the *Serial No.* and *Voltage* on the type plate of the machine itself. We may also need the *Date* and *Article No* of the manual. This information is found on the front cover.

The following restrictions should be observed, as violation of the restrictions may cause cancellation of Struers legal obligations:
Instruction Manuals: Struers Instruction Manual may only be used in connection with Struers equipment covered by the Instruction Manual.

Struers assumes no responsibility for errors in the manual text/illustrations. The information in this manual is subject to changes without notice. The manual may mention accessories or parts not included in the present version of the equipment.

Original instructions. The contents of this manual is the property of Struers. Reproduction of any part of this manual without the written permission of Struers is not allowed.

All rights reserved. © Struers 2018.

Struers
Pederstrupvej 84
DK 2750 Ballerup
Denmark
Telephone +45 44 600 800
Fax +45 44 600 801



Secotom-15 Safety Precaution Sheet

Read carefully before use

1. Ignoring this information and mishandling of the equipment can lead to severe bodily injuries and material damage.
2. The machine must be installed in compliance with local safety regulations. All functions on the machine and any connected equipment must be in working order.
3. The operator(s) must read the Safety and User's Guide sections of this manual and the relevant sections of the manuals for any connected equipment and accessories. The operator(s) must read the Instructions for Use and, where applicable, Safety Data Sheets for the applied consumables.
4. This machine is to be operated and maintained by skilled/trained personnel only.
5. Use only intact cut-off wheels. Cut-off wheels must be approved for min. 5,000 rpm.
6. The machine must be placed on a safe and stable table with an adequate working height and which is able to carry the machine and supplementary accessories and consumables.
7. Operators should ensure that the actual voltage corresponds to the voltage on the rear of the machine. The machine must be earthed. Follow the local regulations. Always turn the power off and remove the plug or the cable before opening the machine or installing additional components.
8. Consumables: only use consumables specifically developed for use with this type of materialographic machine.
9. Observe the current safety regulations for handling, mixing, filling, emptying and disposal of the additive for cooling fluid. Avoid skin contact with the additive for cooling fluid.
10. Keep your hands clear of the cutting table when moving the table.
11. Mind the protruding safety catch when the guard is raised.
12. The workpiece must be securely fixed in a clamping device.
13. Use of working gloves is recommended as specimen may be both very hot and have sharp edges.

Secotom-15
Instruction Manual

- 14.** Use of safety goggles is recommended when using the flushing hose. Only use the flushing hose for cleaning inside the cutting chamber.
- 15.** If you observe malfunctions or hear unusual noises - stop the machine and call technical service.
- 16.** The machine must be disconnected from the mains prior to any service. Wait 5 minutes until residual potential on the capacitors is discharged.
- 17.** Do not cycle mains power more than once every three minutes. Damage to the drive will result.
- 18.** In case of fire, alert bystanders, the fire brigade and cut power. Use a powder fire extinguisher. Do not use water.

The equipment should only be used for its intended use and as detailed in the Instruction Manual.

The equipment is designed for use with consumables supplied by Struers. If subjected to misuse, improper installation, alteration, neglect, accident or improper repair, Struers will accept no responsibility for damage(s) to the user or the equipment.

Dismantling of any part of the equipment, during service or repair, should always be performed by a qualified technician (electromechanical, electronic, mechanical, pneumatic, etc.).

Icons and Typography

Struers uses the below icons and typographical conventions. A list of the Safety Messages used in this manual can be found in the chapter on [Cautionary Statements](#).

Always consult the Instruction Manual for information on the potential hazards marked by the icons fixed to the machine.

Icons and Safety Messages



ELECTRICAL HAZARD

indicates an electrical hazard which, if not avoided, will result in death or serious injury.



DANGER

indicates a hazard with a high level of risk which, if not avoided, will result in death or serious injury.



WARNING

indicates a hazard with a medium level of risk which, if not avoided, could result in death or serious injury.



CAUTION

indicates a hazard with a low level of risk which, if not avoided, could result in minor or moderate injury.



CRUSHING HAZARD

indicates a crushing hazard which, if not avoided, could result in minor, moderate or serious injury.



EMERGENCY STOP

General Messages

**NOTE:**

indicates a risk of damage to property, or the need to proceed with special care.

**HINT:**

indicates additional information and tips.

Colour Inside Logo



The 'colour inside' logo on the cover page of this Instruction Manual indicates that it contains colours which are considered to be useful for the correct understanding of its contents.

Users should therefore print this document using a colour printer.

Typographic conventions

Bold type	indicates button labels or menu options in software programs
<i>Italic type</i>	indicates product names, items in software programs or figure titles
Blue text	indicates a link to another section or webpage
■ Bullets	indicates a necessary work step

User's Guide

Table of Contents	Page
1. Getting Started	
Device Description	11
Checking the Contents of the Packing Box	12
Unpacking Secotom	12
Placing Secotom	13
Getting Acquainted with Secotom	14
Front of Secotom	14
Cutting Chamber.....	15
Rear of Secotom	15
Supplying Power	16
Filling the Cut-off Machine with Cooling Fluid.....	17
Mounting the Cut-off Wheel	18
Height-adjustment of the Cut-off Wheel	20
Cutting Table.....	21
Positioning the Cutting Table	21
Attaching Clamping Tools (accessories)	22
Quick-clamping and Spring Clamp Devices	22
Stands for Specimen Holders.....	23
Electrical Connections in the Cutting Chamber	23
Flushing Hose	25
Debris Collection	26
Noise.....	26
Handling noise (during operation)	26
2. Basic Operation	
Front Panel	27
Reading the Display	29
Manoeuvring in the Menu Structure	30
Acoustic Signals.....	30
Standby Mode.....	30
Software Settings	30
Zero Positions	32
Changing the Language.....	32
Editing Numeric Values	33
Editing Alphanumeric Values	33
Main menu	35
Cutting methods.....	35
Maintenance Menu.....	38
Configuration Menu.....	39
Manual X-stand, accessory	40
Rotary stand, accessory.....	40
Starting the Cutting Process	42
Stopping the Cutting Process.....	42

3. Maintenance	
General Cleaning	43
Daily	43
Weekly	43
Cleaning the Cutting Chamber	44
Checking the Recirculation Cooling Tank.....	44
Monthly	44
Replacing the Cooling Fluid	44
Yearly.....	45
Inspection of Guard.....	45
Testing Safety Devices	45
Spare Parts	45
Maintenance of Cutting Tables.....	46
Maintenance of Cut-off Wheels	46
Storing of Abrasive Cut-off Wheels	46
Maintenance of Diamond and CBN Cut-off Wheels	46
Dressing Cut-off Wheels	47
Testing Cut-off Wheels	47
Changing Cooling Pump Tubes	48
Tube for Water-free Cooling Fluid.....	50
4. Cautionary Statements	51
5. Transport and Storage	53
6. Disposal	54

1. Getting Started

Device Description

Secotom-15 is an automatic cut-off machine for cutting the majority of solid and stable (non-explosive) materials, with a motorized Y-table and recirculation cooling tank. The height of the cut-off wheel is adjusted manually.

The operator starts the process by selecting and mounting the cut-off wheel and then entering the cutting parameters (e.g. cut-off wheel rotation speed and cutting length) into the machine.

The workpiece is secured by using clamping tools – either directly to the cutting table or to a stand which is clamped on the cutting table.

The guard locks when the operator starts the machine. It remains locked until all movement is stopped, and the cutting table is in the selected stop position.

The specimens may be hot after the process and it is therefore recommended to wear gloves when handling the processed specimens.

It is recommended to connect Secotom-15 to an external exhaust system to remove fumes from the cutting process.

In case of power-loss during the cutting process, the guard will unlock. Wait until all movement has stopped before opening the guard.

The emergency stop cuts the power to all moving parts and the guard can be opened once all movements have stopped.

Checking the Contents of the Packing Box

In the packing box you should find the following parts:

- 1 Secotom-15
- 2 Mains cables
- 1 Support pin
- 1 Socket spanner 17 mm
- 1 Hose for connection to exhaust, 51 mm dia., 1.5 m
- 1 Hose clamp, 40-60 mm dia.
- 1 Instruction Manual Set

Unpacking Secotom



NOTE:

Always lift Secotom from underneath the machine

A crane and two lifting straps¹ are required to lift Secotom off the shipment pallet.

Before lifting Secotom into position:

- Remove the screws around the base of the packing crate and lift the entire upper part of the crate.
- Remove the metal brackets securing Secotom to the pallet (a 4 mm Allen key is required to remove the 8 screws that secure the metal brackets).
- Remove the recirculation tank.
- Place the two lifting straps under Secotom.
- Position the straps under Secotom, so that they are on the inside of the feet. See drawing.

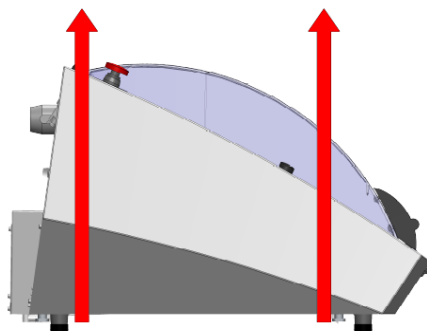

- Use straps which are long enough so that they do not place stress on the guard (use straps of approx. 3-3½ m in length).
- A lifting bar is recommended so that the two straps are kept apart below the lifting point.
- Lift Secotom onto the table.
- Lift the front of Secotom and carefully move into place.



CRUSHING HAZARD

Wear safety shoes when handling heavy machinery.

¹ Crane and straps must be approved to at least twice the weight of the load.



HINT:

Store the packing crate, bolts and brackets for use whenever Secotom is transported/re-located.

Failure to use the original packaging and fittings could cause severe damage to the machine and will void the warranty.

Placing Secotom

- The machine must be placed on a safe and stable table with an adequate working height and which is able to carry at the machine and supplementary accessories and consumables.
 - Check that the Secotom is resting securely with all 4 rubber feet on the table.
- The machine must be close to the power supply.
- The machine must be operated in a well-ventilated room or connected to an exhaust system.

Getting Acquainted with Secotom

Please familiarise yourself with the location and names of all the Secotom components:

MAIN SWITCH

The main switch is located at the rear of Machine.



The EMERGENCY STOP is located on the front of the machine.
Emergency Stop

- Push the red button to Activate.
- Turn the red button clockwise to Release.



NOTE:

Do not use the Emergency stop for operational stop of the machine during normal operation.
BEFORE releasing (disengaging) the Emergency stop, investigate the reason for activating the Emergency stop and take any necessary corrective action.

Front of Secotom

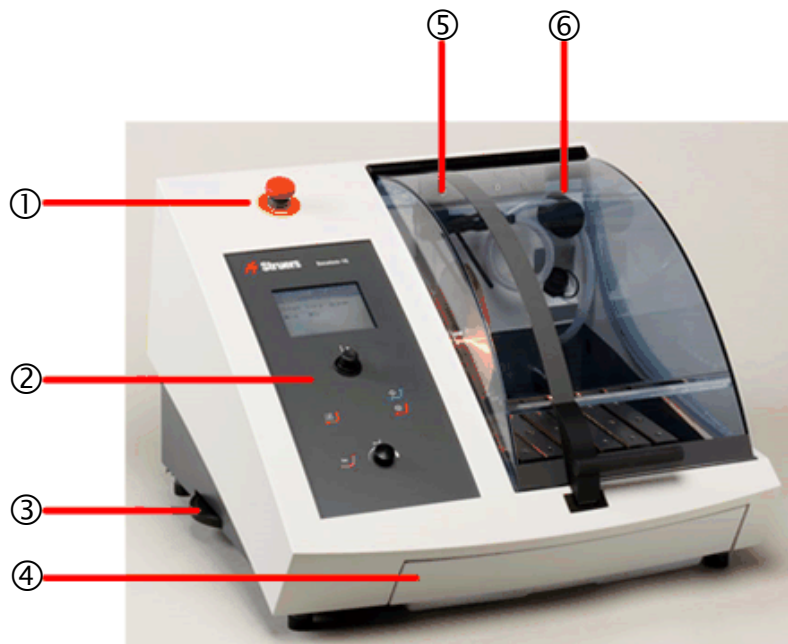

- | | |
|----------------------|----------------------|
| ① Emergency Stop | ④ Cooling fluid tank |
| ② <i>Front Panel</i> | ⑤ Cover |
| ③ Positioning wheel | ⑥ Exhaust |

Secotom-15
Instruction Manual

Cutting Chamber

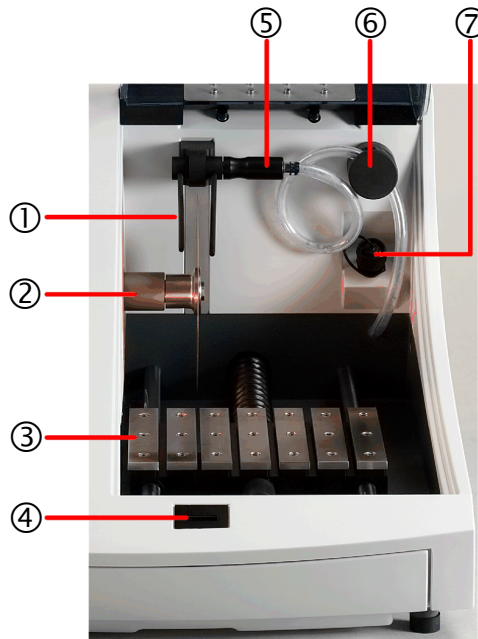

- | | |
|-------------------------|--------------------------------|
| ① Cooling fluid nozzles | ⑤ Flushing Hose |
| ② Cut-off wheel spindle | ⑥ Exhaust |
| ③ Movable cutting table | ⑦ Electrical connection socket |
| ④ Safety lock | |

Rear of Secotom

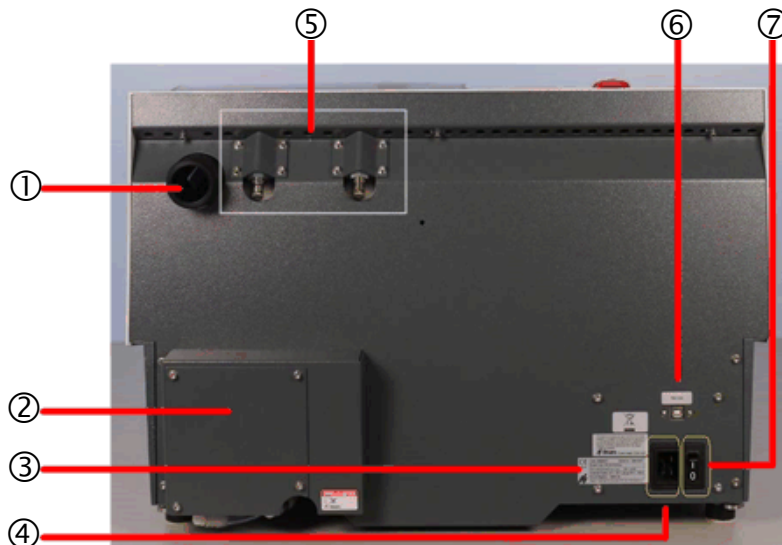

- | | |
|----------------------|------------------|
| ① Flange for Exhaust | ⑤ Hinges |
| ② Pump cover | ⑥ Service socket |
| ③ Type Plate | ⑦ Main switch |
| ④ Mains connection | |

Supplying Power



ELECTRICAL HAZARD

Switch the power off when installing electrical equipment. The machine must be earthed (grounded). Check that the mains voltage corresponds to the voltage stated on the type plate on the side of the machine. Incorrect voltage may result in damage to the electrical circuit.

The Secotom is shipped with 2 types of Mains cables:

Single-phase Supply

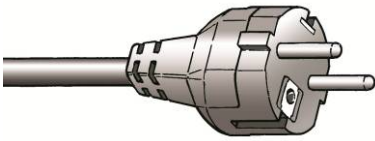

The 2-pin (European Schuko) plug is for use on single-phase, 200-240 V connections.

If the plug supplied on this cable is not approved in your country, then the plug must be replaced with an approved plug. The leads must be connected as follows:

Yellow/green: earth (ground)
Brown: line (live)
Blue: neutral

2-phase Supply



The 3-pin (North American NEMA) plug is for use on 2-phase, 200-240 V power connections.

If the plug supplied on this cable is not approved in your country, then the plug must be replaced with an approved plug. The leads must be connected as follows:

Green: earth (ground)
Black: line (live)
White: line (live)

Connection to the Machine

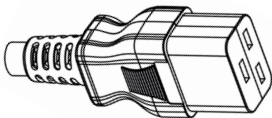

- Connect the power cable to the Secotom. (IEC 320 C19 connector).
- Connect to the mains power supply.

Filling the Cut-off Machine with Cooling Fluid

The Secotom has a built-in cooling fluid system. The fluid coming from the nozzles passes over the cut-off wheel and collects in the drain in the cutting chamber; where it then returns to the tank, which is located under the cutting chamber.

- Slide the cooling fluid tank out gently.



- Fill the tank with a 3 % solution of Struers additive, Corrozip: 140 ml Corrozip and 4.6 l water (4.7 oz Corrozip to 1 gal water)
- Slide the tank back into position.



HINT:

It is very important that the concentration of the Corrozip in the cooling fluid is between 2.7 % and 3.3 %. Check the concentration of Corrozip with a refractometer. Corrozip concentration = $1.9 \times \text{°Brix value}$.

Water Sensitive Materials

Struers Water-free Cutting Fluid is available for cutting water sensitive materials.



NOTE:

The tube in the cooling fluid pump **MUST** be replaced by a special tube when using Water-free Cutting Fluid. The standard tube will only last for a few hours because it will react with the Water-free Cutting Fluid. Tubes for Water-free Cutting are available as an accessory (Cat.no.: 05996921).

For instructions on exchanging the tube, please see the section on [Changing Cooling Pump Tubes](#) on page 48 of the Instruction Manual.

Optimising Cooling

Sufficient cooling is very important for ensuring the best cutting quality and to avoid burning of the workpiece and damaging the cut-off wheel.

Optimise cooling effect using the following tips:

- Always use additive to protect the cutting machine from corrosion and to improve cutting and cooling qualities.
- Ensure that there is sufficient water in the tank for optimal cooling.
- Maintain the correct concentration of additive in the cooling water (percentage stated on the container of the Struers Additive, Corrozip).
- Remember to add Struers Additive each time you refill with water. See hint on page 17.
- It is recommended to change the cooling water at least once a month to prevent the growth of microorganisms.
- Only use Struers' own additives.
- **Do not** use oil, petrol, or turpentine-based additives, as they can affect the tubes for the cooling water.

Mounting the Cut-off Wheel²

- Lift the guard to the "open" position (the position where it will stay up and open when released).



CAUTION

Mind the protruding safety catch when the guard is raised.

- Lift the cooling fluid nozzles to gain access to the cut-off wheel mounting.

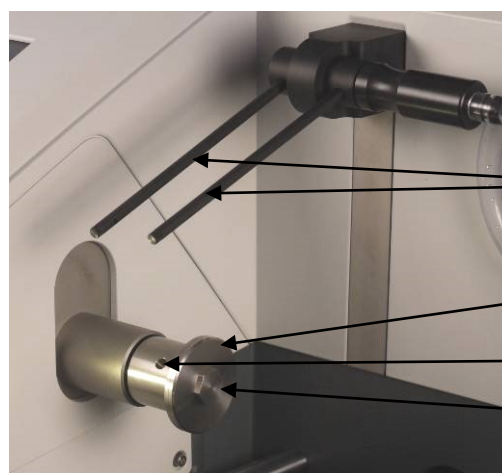

- Insert the support pin into the hole on the cut-off wheel spindle. Use the socket spanner 17 mm to loosen the flange screw.

² The following illustrations are of Secotom-50. Mounting of the cut-off wheel is identical.



- Remove the outer flange.



NOTE:

The tolerance between the spindle and inner flange is very small which means that the two surfaces must be absolutely clean.

Never try to squeeze the cut-off wheel on as this may damage the spindle or the cut-off wheel. If there are any small burrs, remove them with grinding paper grit size 1200.

NOTE:

When mounting cut-off wheels with a 12.7 mm centre hole, make sure that the 22 mm arbour insert has been removed. Failure to do this will result in the cut-off wheel being pressed out of shape.

- Before mounting the cut-off wheel, test it for damages. See Testing Cut-off Wheels on page 47.
- Mount the cut-off wheel (using the 22 mm insert if necessary) and remount the outer flange, with the machined face towards the inner flange.
- Insert the support pin in the hole in the inner flange.

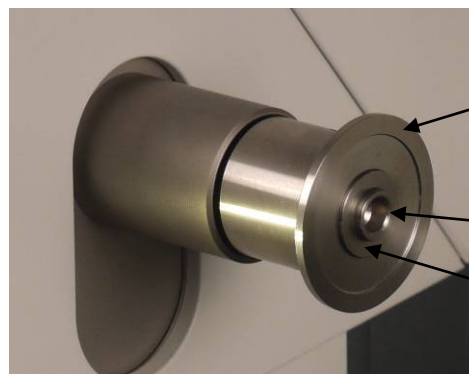

Inner flange

12.7 mm axle

Insert for wheels with
22 mm arbor hole

- Gently fasten the flange screw using the socket spanner 17 mm. (The screw should be tightened with a force of maximum 5 Nm / 4 lbf-ft).

- Lower the cooling fluid nozzles to their operating positions.



Height-adjustment of the Cut-off Wheel

The distance between the cut-off wheel spindle and the cutting table can be adjusted to suit the individual cut-off wheels or wear caused by the cutting process.

- Use the positioning wheel on the left-hand side of Secotom.

Cutting Table

The Secotom is fitted with a moving cutting table. Movement of the table is controlled using the joystick on the Control Panel and through the software, which is described in [Basic Operation](#)

The table has 8 mm T-slots, which are used to secure clamping tools.

Although these clamping tools are available as accessories, details about the table and the clamping tools are described in this and the following sections.



Positioning the Cutting Table

The cutting table must be manually positioned before starting the process.



CRUSHING HAZARD

Keep hands clear of the cutting table when moving it.

- Use the joystick on the Control Panel to move the cutting table.
 - Pull the joystick towards you to move the cutting table away from the cut-off wheel or push the joystick away from you to move the cutting table towards the cut-off wheel.

Attaching Clamping Tools (accessories)

There are several types of clamping tools available as accessories (please refer to the [Secotom brochure](#) for details of the range available).
Some of these are mounted directly on the cutting table while others with more sophisticated features, need to be fixed on a stand using a dovetail holder.



NOTE:

When fitting clamping tools, always ensure that they do not block the cut-off wheel.
Failure to do this will result in the clamping tools and/or cut-off wheel being damaged.



CAUTION

Mind the protruding safety catch when the guard is raised.

Quick-clamping and *Spring Clamp Devices*

- Position the back stop and the clamping device as shown in the illustration.



- Tighten the nuts to secure.

Stands for Specimen Holders

Place the stand on the cutting table.

- Place the stand on the cutting table by sliding the securing bolts align in the T-slot and tighten the nuts.
- For stands requiring an electrical supply:
Connect the cable as described in Electrical Connections in the Cutting Chamber on the next page.
- Clamp the workpiece in the dove tail specimen holder.
- Slide the dovetail specimen holder into the stand and secure it.



Electrical Connections in the Cutting Chamber

The Manual X-stand and the Rotary stand require electrical connections. These are supplied through the electrical connection socket inside the cutting chamber.

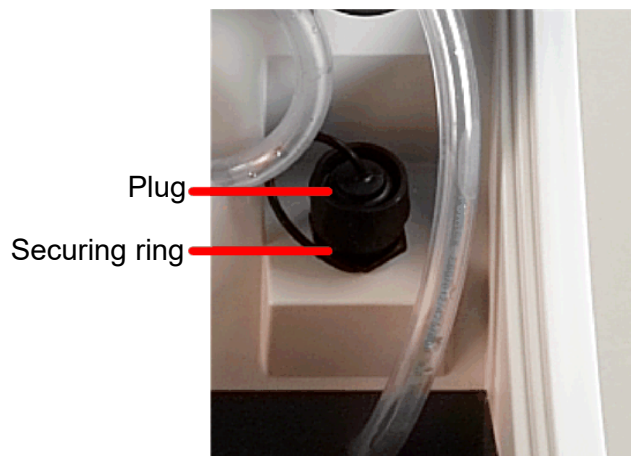

- Remove the cap on the electrical connection socket in the cutting chamber.
- Connect the accessory to the electrical connection socket.



NOTE:

The different electrical accessories can be exchanged while Secotom is switched on.

NOTE:

The plugs on these accessories provide specific pin connections. If for some reason you have a problem with a connection, do not attempt to change the connections in the clamping tool plugs or connection socket.

Contact Struers Service for information.

- A pop-up on the display confirms that the accessory is now connected.
- Gently tighten the securing ring.



NOTE:

Always replace the socket's cap when not in use.

Flushing Hose

The Secotom comes complete with a flushing system. This enables the cutting chamber to be rinsed clean of any debris discarded during the cutting process. Flushing is operated through the Control Panel button.



CAUTION

Wear gloves to avoid skin contact with the additive for cooling fluid.

Do not press FLUSH  until the flushing gun points into the cutting chamber.

- Remove the hose from the cooling fluid nozzles.



- Holding the hose in the cutting chamber, press FLUSH .
- To stop flushing, press FLUSH  again.



NOTE:

Remember to replace the hose in its holder when you have finished flushing the cutting chamber.

Debris Collection

Secotom has two systems to keep the debris from polluting the cutting fluid and possibly blocking the nozzles. The first is a filter drain that prevents larger pieces from entering the tank. The second measure is a magnet in the tank that collects magnetic particles.



NOTE:

Check the basket and the magnet for cutting debris before starting the cutting process; a blocked drain can result in water overflow and too little water in the tank to secure a sufficient cooling.

Connection to an External Exhaust System

Struers recommends the use of an exhaust system as workpieces may emit harmful gases when cut.

The unit is prepared for connection to an exhaust system via a 50 mm ventilation flange at the rear of the cabinet.

- Mount an exhaust hose from your local exhaust system onto the ventilation flange.

Noise

Find the sound pressure level value under Technical Data.

Handling noise (during operation)

Different materials have different noise characteristics. Decreasing the rotational speed and/or the force with which the workpiece is pressed against the cut-off wheel, will lower the noise. Processing time may increase.



CAUTION





Prolonged exposure to loud noises may cause permanent damage to the hearing.
Use hearing protection if exposure to noise exceeds levels set by local regulations.

2. Basic Operation

Front Panel

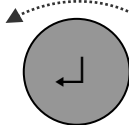

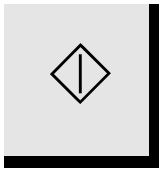
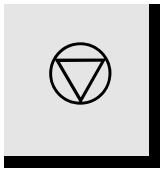
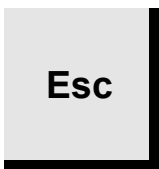
Front Panel Controls

Key	Function	Key	Function
Turn/Push knob	 <p data-bbox="422 470 798 593">Multifunction knob. Turn knob to move the cursor or to adjust settings. Push knob to select (ENTER)</p>	Joystick	 <p data-bbox="1133 470 1524 560">Move up- or downwards to position the cutting table</p>
START	 <p data-bbox="422 672 798 705">Starts the cutting process.</p>	STOP	 <p data-bbox="1133 672 1524 705">Stops the cutting process.</p>
ESC	 <p data-bbox="422 862 798 929">Leaves the present menu or aborts functions/changes.</p>	FLUSH	 <p data-bbox="1133 862 1524 929">Starts and stops the FLUSH operation.</p>

Reading the Display

The display on the front panel provides different levels of status information. For example, when the machine is switched on using the Mains switch located at the rear, on the left-hand side of the machine, the display informs you about the physical configuration of the Secotom and the version of software that is installed:

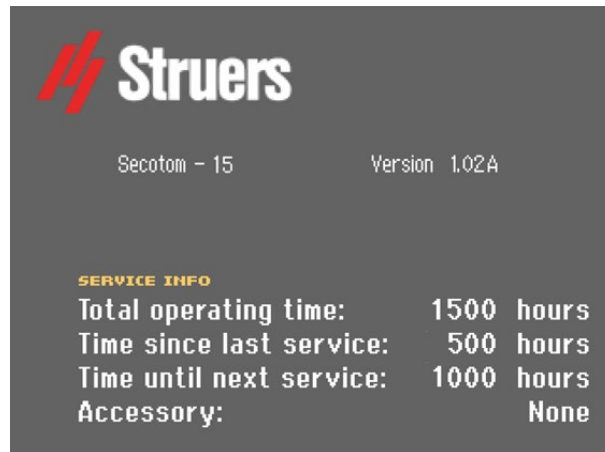

When operating the Secotom, this display is the user-interface to Secotom's software.

The display is primarily divided into 2 areas. The position of these areas and the information they contain are explained in the illustration below, which uses the *Options* menu as an example:

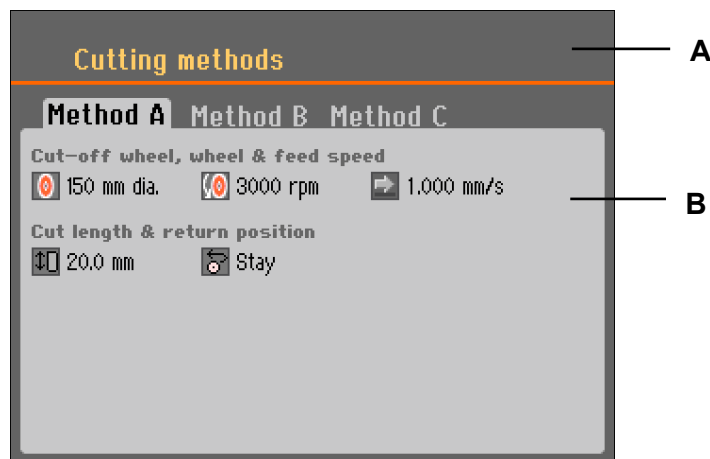

- A** Heading: this is a navigational aid, telling you where you are in the software's hierarchy.
- B** Information fields: these will be either numerical values or text fields, providing information associated with the process shown in the heading. The inverted text shows the cursor position.

Manoeuvring in the Menu Structure

To select items in the menu:



Turn knob to select a menu, method group or a parameter.



Push knob to open or activate the selection.

Esc Press **Esc** to return to the Main menu.

Acoustic Signals

When pressing a key, a short beep indicates that the command has been accepted, whereas a long beep indicates that the key cannot be activated now

This 'short' sound can be switched on or off in the *Configuration menu*.

Standby Mode

To increase the lifetime of the display, the backlight is dimmed automatically if Secotom-50 has not been used for 10 min.

■ Press any key to re-activate the backlight.

Software Settings

When switching Secotom on for the first time, the *Select language* screen will appear (to change the language after this, refer to [Changing the Language](#)”).



Turn knob to select the language you prefer.



Push knob to accept the language.

You will now be prompted to set the time.



Turn knob to select and to adjust the settings.

- Push knob to accept the settings.
You will now be prompted to set the date.



- Turn knob to select and to adjust the settings.
- Push knob to accept the settings.
- When Time and Date have been set, turn knob to select *Save and Exit*.
- Push knob to *Save and Exit* (Save the settings and return to the *Main menu*).
The *Main menu* now appears in the language you have chosen.

During normal operation, immediately after start-up, where the splash screen is displayed, the software goes to the screen that was used before the machine was switched off. Thus, you can continue exactly where you left last time the machine was used. To go to the *Main menu*, use the **Esc** key. The *Main Menu* is the highest level in the menu structure. From this menu, you can enter all the other menus.

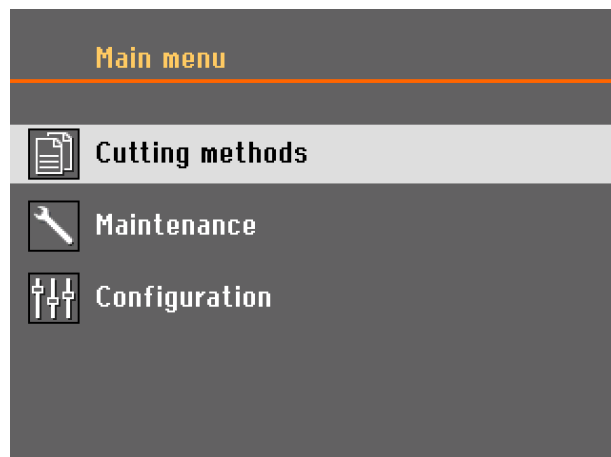

Zero Positions

Zero positions are calibrated after each 5th start-up, **or** if reference positions have been lost.

Changing the Language



Turn the knob to select *Configuration*.



Push knob to activate the *Configuration Menu*.



Turn knob to select *Language*.

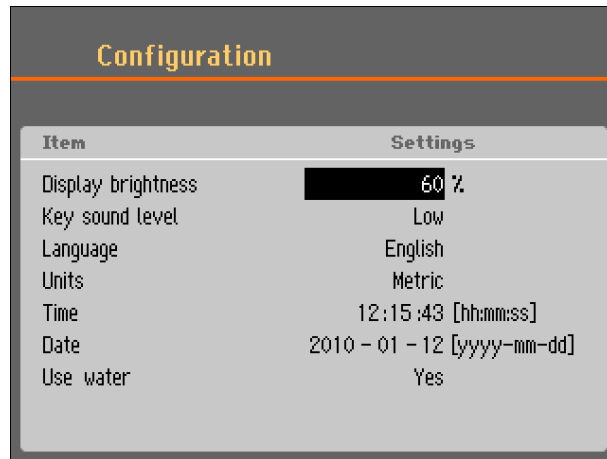

Push knob to activate the *Select language* pop-up menu.



Turn knob to select the language you prefer.



Push knob to accept the language.

The *Configuration* menu now appears in the language you have chosen.

Check if there are any other settings that need changing in the *Configuration* menu. If not, Push **ESC** to return to the main menu.

Otherwise use the Turn/Push knob to select and change the required parameters.

Editing Numeric Values



Turn knob to select the value to be changed, e.g. *Wheel speed*:



Push knob to edit the value.

A scroll box appears around the value.



Turn knob to increase or decrease the numeric value.



Push knob to accept the new value.

(Pressing **Esc** aborts the changes, preserving the original value.)

Editing Alphanumeric Values



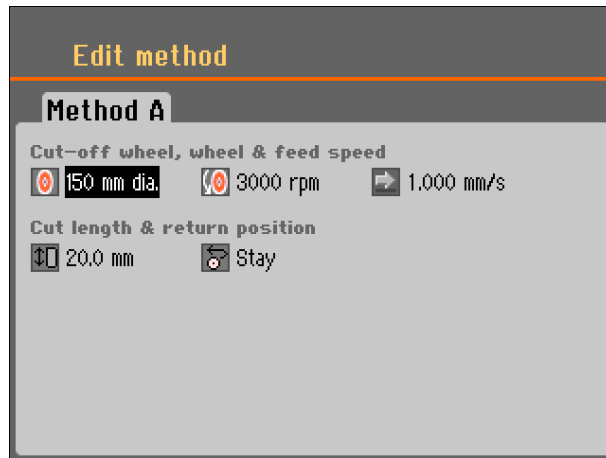

Turn knob to select the alphanumeric value to be changed, e.g. *Return position*

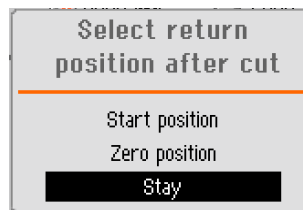

 Push knob to edit the value.

A pop-up menu appears.



 Turn knob to select the correct choice.



 Push knob to accept the new selection and to continue or to return to the previous screen.
(Pressing Esc aborts the changes, preserving the original setting.)



NOTE:

If there are only two options, the popup box is not displayed. Pressing the knob (Enter) will toggle between the 2 options.

Main menu

The *Main menu* is the highest level in the menu structure. From this menu, you can enter the *Cutting methods*, *Maintenance* and *Configuration* menus.

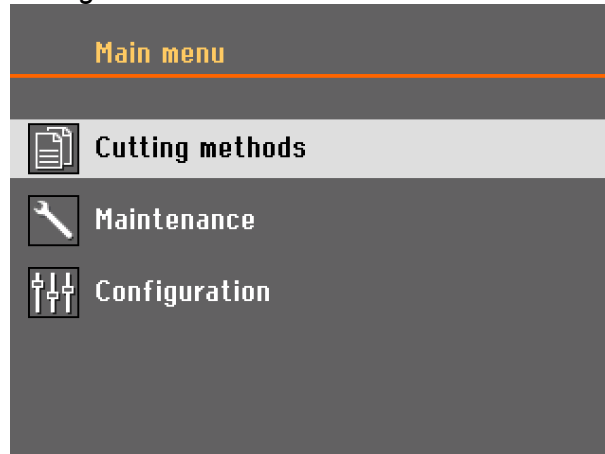

Cutting methods

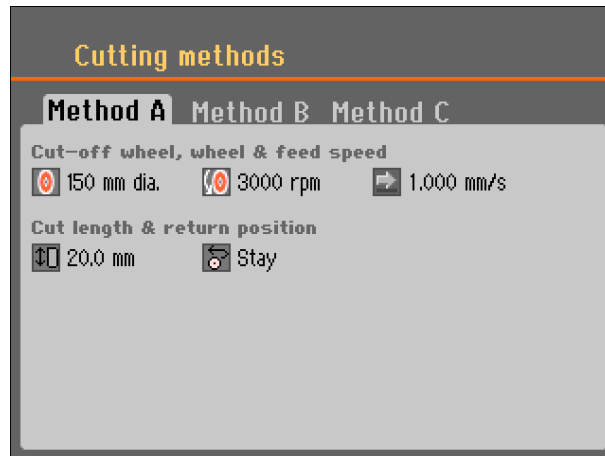

Editing Cutting methods:



Turn knob to select the cutting method to be edited, *Method A* in this example.



Push knob to edit the method.



Turn knob to select the parameter to be edited e.g. *Cut-off wheel*.



Push knob to edit the parameter then select a cut-off wheel from the menu.

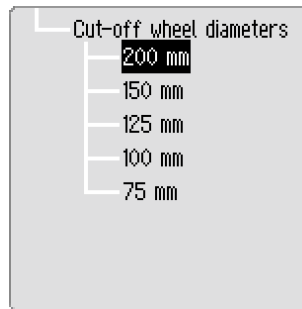

Changes made to the cutting method will automatically be saved. To re-set to default values, see the section [Maintenance](#) menu.

Return position

There are three available options for the position the cut-off wheel will return to after the cutting process is complete:

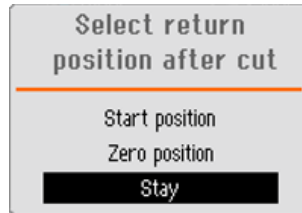

Start position: Cutting table returns to the start position.

Zero position: Cutting table returns to zero position.

Stay: Cutting table does not move after cutting.

OptiFeed

If the motor becomes overloaded during cutting (motor load > 150 %), the OptiFeed function will automatically reduce the feed speed. When the overload has been reduced, the feed speed will be increased to the pre-set level.

Maintenance Menu

The Maintenance menu has three under menus.

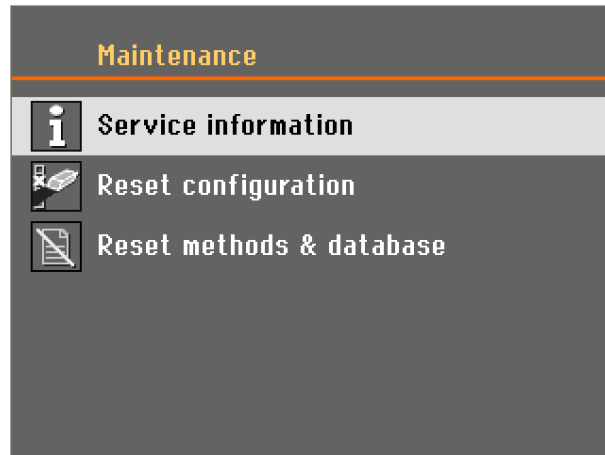

Service information

Information regarding the equipment, mainly to be used in connection with service.

Reset configuration:

Resets all parameters in the *Configuration menu* to default values.

Reset methods & database

Resets all methods and the database to default values.

Configuration Menu

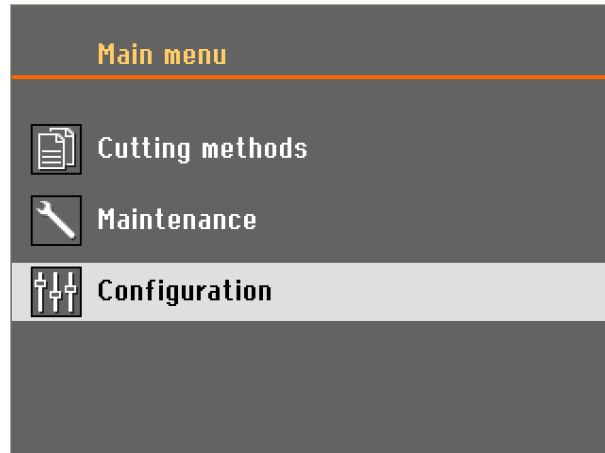

The *Configuration* menu contains the parameters which apply to all methods.

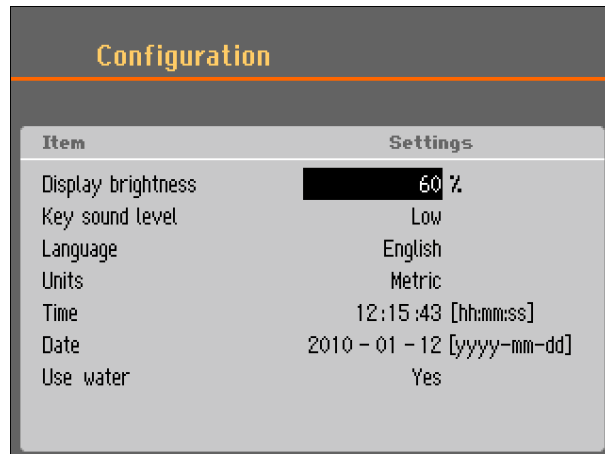

Manual X-stand, accessory

When the manual X-stand is connected a read out for the x-position will appear on the display. X-position can be reset for easy cutting of a specific width.

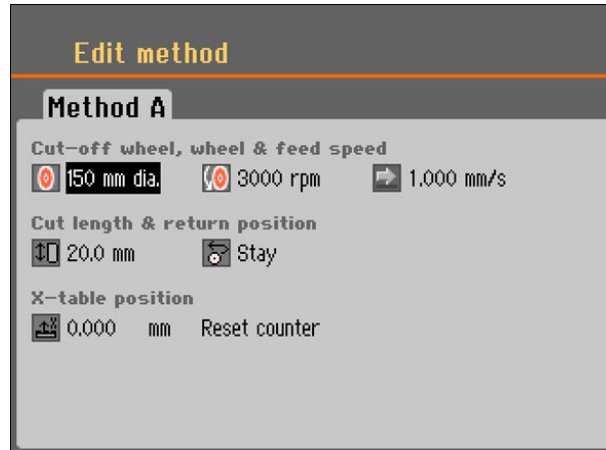

Rotary stand, accessory

When the rotary stand is connected a read out for the chuck mode and the x-position will appear on the display. X-position can be reset for easy cutting of a specific width.

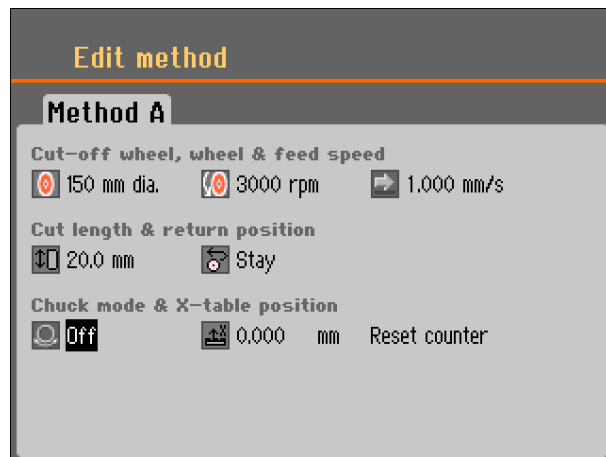

There are three options available in chuck mode:

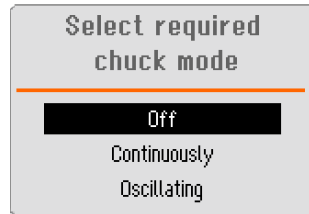

Off	The specimen holder will not turn.
Continuously	The specimen holder will turn around continuously in the same direction as the cut-off wheel.
Oscillating	The specimen holder will oscillate during the cutting process. X-position can be reset for easy cutting of a specific width.

Starting the Cutting Process

- Secure the workpiece on the cutting table.
- Position the cutting table in the correct place.
- Ensure that the cooling fluid nozzles are lowered into position.
- Close the guard (the machine cannot be started before the guard is down).



NOTE:

The guard cannot be lifted whilst cutting is in progress.

- Select a Cutting method
- Set/check the correct values.
- Start the cutting process by pressing START .
- If required, Feed speed, Rotation speed and Cutting length can be changed during the cutting process.



NOTE:

Check that there is a steady flow of cooling fluid from the nozzles.

Stopping the Cutting Process

- When the specified cut length is reached, the cut-off wheel will automatically stop rotating and the cutting table will return to the selected stop position.



HINT:

The cutting process can be stopped at any time by pressing STOP  on the Control Panel.

- If the machine has been stopped with STOP , the cutting table will stay in position.
To return the cutting table to its zero position, press the joystick downwards once. Please note that the guard has to be closed in order to carry out this operation. If the guard has been opened, press and hold the joystick down to move the cutting table.

3. Maintenance

Proper maintenance is required to achieve the maximum uptime and operating lifetime of the machine. Maintenance is also important in ensuring your machine's continued safe operation. The maintenance procedures described in this section must be carried out by skilled or instructed persons.

General Cleaning

To ensure a longer lifetime for your Secotom Struers strongly recommends daily cleaning of the cutting chamber. Clean the cutting chamber thoroughly if the Secotom is not to be used for a longer period of time.

Daily Machine

- Clean all accessible surfaces with a soft, damp cloth.



NOTE:

Do not use a dry cloth as the surfaces are not scratch resistant. Grease and oil can be removed with ethanol or isopropanol.

NOTE:

Never use acetone, benzol or similar solvents.

- Clean the cutting chamber, especially the T-slot cutting table.



HINT:

Leave the guard open when the machine is not in use to let the cutting chamber dry completely.

Weekly

The machine should be cleaned regularly, in order to avoid damaging effects to the machine and the specimens from abrasive grains or metal particles.

- Clean painted surfaces, and the control panel with a soft damp cloth and common household detergents.
- For heavy duty cleaning, use Struers Cleaner.
- Clean the guard with a soft damp cloth and a common household anti-static window cleaning agent.
- Do not use harsh or abrasive cleaning agents.



NOTE:

Ensure that no detergent or cleaning agent residue is flushed into the cooling tank; excess foaming will occur.

Cleaning the Cutting Chamber

- Remove the clamping device(s).
 - Store the clamping device(s) in a dry place or replace on the cutting table after cleaning.
- Clean the cutting chamber thoroughly.
- Oil the spindle/bushing where the cut-off wheel is mounted (e.g. with universal household oil).

Checking the Recirculation Cooling Tank

- Check the level of the cooling fluid after 8 hours use or at least every week. Refill if necessary.
- Replace the cooling fluid if it appears dirty (build-up of cutting debris).
 - Slide the cooling fluid tank out gently.
 - Remove the screw cap and pour out the used cooling fluid.
 - Rinse the tank with clean water, periodically shaking the tank to release any debris that has accumulated on the bottom of the tank. Repeat the rinsing process until the tank is clean.
 - Replace the screw cap.
 - Fill the tank with a 3 % solution of Struers additive, Corrozip:
 - Slide the tank back into position.
- Please see the instructions for use on the label.
- To check the concentration of additive, use a refractometer. See Filling the Cut-off Machine with Cooling Fluid

It is recommended to change the cooling water at least once a month to prevent the growth of microorganisms.



CAUTION

Wear gloves to avoid skin contact with the additive for cooling fluid.

Do not press FLUSH  until the flushing gun points into the cutting chamber.

Cooling Fluid Nozzles

- Should the cooling fluid nozzles become blocked, clear the blockage with a thin piece of wire (e.g. a paper clip).

Monthly

Replacing the Cooling Fluid

- Replace the cooling fluid in the Recirculation Cooling Tank at least once a month.

Yearly Inspection of Guard

The guard consists of a metal frame and a composite material (SAN) that protects the operator. In the event of damage, the guard will be weakened and offer less protection.

- Visually inspect the guard for signs of wear or damage (e.g. dents, cracks).



NOTE:

Carry out inspection at more regular intervals if Secotom is used for more than one 7 hour shift a day.

Replacing the Guard

To ensure its intended safety, the guard must be replaced every 5 years.

The guard should be **replaced immediately** if it has been weakened by collision with projectile objects or if there are visible signs of deterioration or damage.

Testing Safety Devices

The guard has a safety switch system to prevent the cut-off wheel from starting while the guard is open. Furthermore, a locking mechanism prevents the operator from opening the guard until the cut-off wheel stops spinning.

- Start a cutting process.
- Activate the Emergency-stop.

If cutting does not stop, press STOP  and contact Struers Service.

- Open the guard.
- Press START .

If cutting starts, activate Emergency stop and contact Struers Service.



WARNING

Do NOT use the machine with defective Safety Devices.
Contact Struers Service.

Spare Parts

Please see [Spare Parts and Diagrams](#) in the Reference Guide section of the Instruction Manual.

*Maintenance of Clamping
Devices*



NOTE:

It is recommended to thoroughly clean and lubricate the Quick Clamping Device and Vertical Quick Clamping Device at regular intervals.

Maintenance of Cutting Tables

The stainless-steel bands (available as spare parts) should be replaced if damaged or worn.

**Turning or Replacing Steel
Bands on the Cutting Table**

During normal use, it is not uncommon for the cutting table steel bands located on either side of the cutting area to be damaged. If the bands are only damaged on one side, then they can be turned. If they are very badly damaged or damaged on both sides, replace the bands (available as a Spare Part).

Maintenance of Cut-off Wheels
*Storing of Abrasive Cut-off
Wheels*

These cut-off wheels are sensitive to humidity. Therefore, do not mix new, dry cut-off wheels with used humid ones. Store the cut-off wheels in a dry place, horizontally on a plane support.

*Maintenance of Diamond and
CBN Cut-off Wheels*

The precision of diamond and CBN cut-off wheels (and thus the cut) depends on how carefully the following instructions are observed:

- Never expose the cut-off wheel to a heavy mechanical load, or heat.
- Store the cut-off wheel in a dry place, horizontally on a plane support, preferably under light pressure.
- A clean and dry cut-off wheel does not corrode. Therefore, clean and dry the cut-off wheel before storing. If possible, use ordinary detergents for the cleaning.
- Regular dressing of the cut-off wheel is also part of the general maintenance.

Dressing Cut-off Wheels

For diamond and CBN cut-off wheels, only.

A newly dressed cut-off wheel will give an optimum cut. A badly maintained and dressed cut-off wheel demands a higher cutting pressure that will result in more frictional heat. The wheel may also bend and cause a skew cut. A combination of both factors may result in damage to the cut-off wheel.

To dress the cut-off wheel, use the aluminium oxide dressing stick supplied with the cut-off wheel.

There are two ways to dress a cut-off wheel:

1) Mount the dressing stick like a workpiece.

- Cut through the dressing stick using a moderate cutting pressure and plenty of cooling fluid.
- Repeat the treatment if the cut-off wheel does not cut satisfactorily.

2) Use the Manual Dresser – see Accessories in [Secotom brochure](#)



NOTE:

Do not perform more dressing than necessary as this will cause needless wear on the wheel.

NOTE:

Badly dressed cut-off wheel is the most frequent reason for damage to the wheel.

Testing Cut-off Wheels

Cut-off wheels must be inspected before use. There are two types of cut-off wheels: Abrasive, Resin bond cut-off wheels and Diamond/CBN cut-off wheels.

To test an abrasive cut-off wheel for damages:

- Visually inspect the surface for cracks and chips.
- Mount the cut-off wheel, close the guard and let it rotate with full speed.
- If there are no visible damages and it did not break during the high-speed test, it passed the test. If the cut-off wheel shows cracks, it is unsafe to use.

To test a Diamond/CBN cut-off wheel, perform a ring test:

- Let the cut-off wheel hang over your index finger.
- With a pencil (not metal), gently tap the cut-off wheel around the edge.
- The wheel passes the test if it gives a clear metallic tone when tapped. If the wheel sounds dead anywhere, it is cracked. Do not use it.

Changing Cooling Pump Tubes

To exchange the tube:

- Remove the four screws on the protection plate on the rear of the machine.

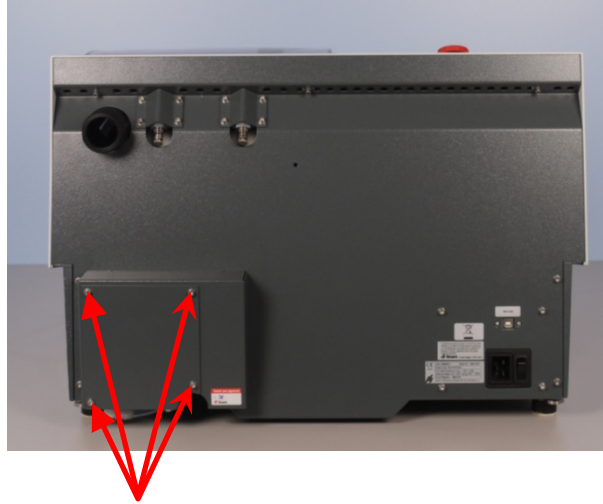

- Remove the three screws on the cover on the cooling pump.

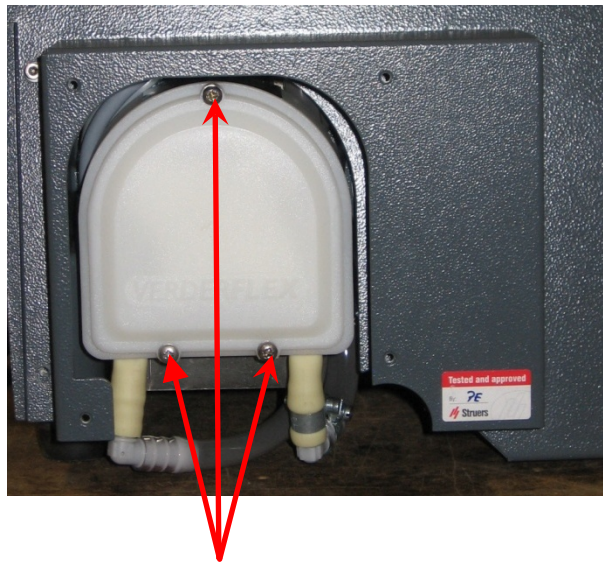

- Remove the tube from the pump axle.

Pump axle

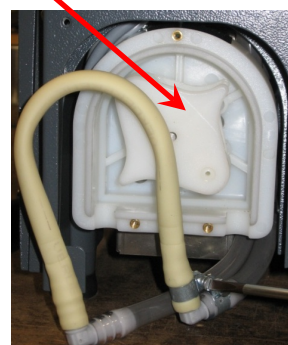
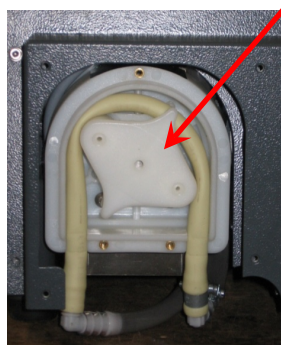

- Loosen the hose clamp and carefully remove the tube ends from the connectors.
- Attach the new tube to the connectors and tighten the hose clamp (the hose clamp should be on the end of the tube that directs water into the cutting chamber, as this will have the greatest pressure – see picture).
- Lubricate the tube along its length with the silicon grease enclosed (this will help the rollers in the pump to turn smoothly).
- Press the tube into position around the pump axle. Mount the tube correctly in the pump:

Correct:

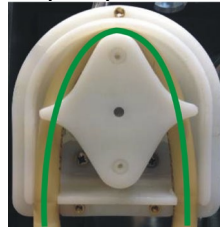

Incorrect:

Too loose

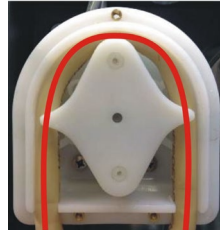

Excess volume between the rollers will press "waves" of fluid which will stretch the tube; lifetime of the tube will be reduced.

Too tight

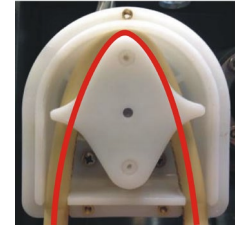

The tube is stretched; lifetime of the tube will be reduced.

- Replace the pump cover and the protection plate.

Tube for Water-free Cooling Fluid When working with Water-free Cutting Fluid, the standard tube mounted in the cooling fluid pump will only last for a few days.



NOTE:

Tubes for Water-free Cutting are available as an accessory. See [Accessories and Consumables](#).

4. Cautionary Statements



WARNING

Do NOT use the machine with defective Safety Devices.
Contact Struers Service.



WARNING

In case of fire, alert bystanders, the fire brigade and cut power.
Use a powder fire extinguisher. Do not use water.



WARNING

Safety critical components are to be replaced after a maximum
lifetime of 20 years.
Contact Struers Service for information.



CRUSHING HAZARD

Wear safety shoes when handling heavy machinery.



ELECTRICAL HAZARD

Switch the power off when installing electrical equipment.
The machine must be earthed (grounded).
Check that the mains voltage corresponds to the voltage stated on
the type plate on the side of the machine. Incorrect voltage may
result in damage to the electrical circuit.



CAUTION

Mind the protruding safety catch when the guard is raised.



CRUSHING HAZARD

Keep hands clear of the cutting table when moving it.



CAUTION

Mind the protruding safety catch when the guard is raised.



CAUTION

Wear gloves to avoid skin contact with the additive for cooling fluid.

Do not press FLUSH  until the flushing gun points into the cutting chamber.



CAUTION

Prolonged exposure to loud noises may cause permanent damage to the hearing.

Use hearing protection if exposure to noise exceeds levels set by local regulations.

5. Transport and Storage



NOTE:

Store the packing crate, foam packaging, bolts and fittings for future use.

Failure to use the original packaging and fittings could cause severe damage to the tester and will void the warranty.

Follow these steps:

- Clean the machine
- Disconnect the power supply, and exhaust system.
- Empty the Recirculation Cooling Tank.
- Position the lifting straps³ on Secotom.

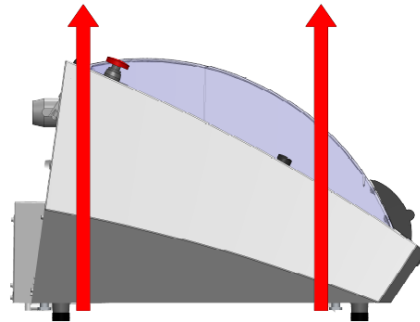

- Move it to its new position.
- Replace the Recirculation Cooling Tank.

If the machine is bound for long-time storage or shipping, follow these additional steps:

- Place the machine on the blocks on the original pallet.
- Secure the machine using the original transport brackets.
- Build the crate.
- Place the accessories and other loose items in the crate.
- To keep the machine dry, plastic-wrap the machine and place a bag of desiccant (silica gel) with the machine, too.

At the new location, check that the facilities required are in place.

- Use the Pre-Installation Checklist (if it is lost, contact Struers for a copy)

³ The crane and the straps must be approved to at least twice the weight of the load.

6. Disposal

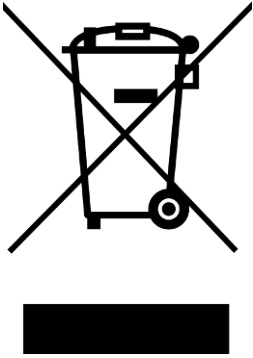

Equipment marked with a WEEE symbol  contain electrical and electronic components and must not be disposed of as general waste.

Please contact your local authorities for information on the correct method of disposal in accordance with national legislation.

NOTE:

Swarf must be disposed of according to the current safety regulations for handling and disposal of swarf/ additive for cooling fluid.

NOTE:

The cooling fluid will contain additive and cutting swarf and may **NOT** be disposed of into a main drain.

Cooling fluid must be disposed of in compliance with local safety regulations.

Please note:

Depending on which metals are being cut, it is possible that the combination of the metallic swarf (cutting debris) from metals with a large difference in electro positivity (a large distance apart in the electrochemical series), could result in exothermic reactions when 'favourable' conditions are present.

Therefore, it is always good practice to bear in mind which metals are being cut and the amount of swarf produced.

Examples:

The following are examples of combinations which could result in exothermic reactions if a large amount of swarf is produced during cutting/ grinding on the same machine, and when favourable conditions are present:

Aluminum and Copper

Zinc and Copper



WARNING

In case of fire, alert bystanders, the fire brigade and cut power. Use a powder fire extinguisher. Do not use water.

Reference Guide

Table of Contents	Page
1. Struers Knowledge	56
2. Accessories and Consumables	
Accessories	57
Consumables	57
Cut-off Wheels	57
Other consumables	57
3. Trouble-Shooting	58
4. Service	65
Service Check	66
5. Spare Parts and Diagrams	
Safety Related Parts of the Control System (SRP/CS)	67
Spare Parts List	68
Circuits and Diagrams	69
15993050 Secotom-15/-50, Block diagram	70
15993100 Secotom-15/-50, Circuit diagram – Machine	71
15993100 Secotom-15/-50, Circuit diagram - Accessories	72
15993100 Secotom-15/-50, Circuit diagram - Safety Related Circuits	73
Water Diagram, Secotom 15991005	74
5. Legal and Regulatory	
FCC Notice	75
EN ISO 13849-1:2015	75
6. Technical Data	76

1. Struers Knowledge

Materialographic cutting is where most microstructure analysis begins.

A good understanding of the cutting process can help to select suitable clamping and cutting methods and thereby ensure the high-quality cut.

Minimizing cutting artefacts will help the remaining materialographic process and act as a good base for efficient and high-quality preparation.



HINT:

For further information, see the section on [Cutting](#) on the Struers website.

2. Accessories and Consumables

Accessories

Please refer to the [Secotom Brochure](#) for details of the range available.

Consumables

The use of Struers consumables is recommended. Other products (e.g. coolants) may contain aggressive solvents, which dissolve e.g. rubber seals. The warranty may not cover damaged machine parts (e.g. seals and tubes), where the damage can be directly related to the use of non-Struers consumables.

Cut-off Wheels

Please refer to the Selection Guide in the [Struers Cut-off Wheels brochure](#) or [Struers Consumables Catalogue](#).

Other consumables

Specification	Cat. No.
<p><i>Corrozip</i> Additive for Cooling Fluid. To protect the machine from corrosion and to improve cutting and cooling qualities. For Recirculation Cooling Unit. 1 l 5 l</p>	<p>449900045 449900046</p>
<p><i>Corrozip-Cu</i> Additive for Cooling Fluid. To protect the machine from corrosion and to improve cutting and cooling qualities. For Recirculation Cooling Unit. For machines which mainly cut copper and copper alloys. 1 l 5 l</p>	<p>49900068 49900069</p>
<p><i>Water-free Cutting Fluid</i> Water free Cutting Fluid for cutting of water-sensitive materials 5 l</p>	<p>49900070</p>
<p><i>Tube for Water-free Cutting</i> Pump tube for use with Water-free Cutting Fluid 1 pc</p>	<p>05996921</p>
<p><i>Dressing stick</i> Aluminium oxide stick, 1 pc</p>	<p>40800044</p>

3. Trouble-Shooting

No.	Message	Explanation	Action Required
#8	Selected cut length exceeds available cutting capacity. OK: Automatic cut length will be set. Cancel: Go back to edit method.	Insufficient cutting capacity for set length.	Select <i>OK</i> to set cut length automatically or <i>Cancel</i> to edit method.
#106	Machine failed during Power-On Self Testing. Please try to restart the machine. If problem persists, please contact Struers technical support.	A critical error is detected during Power-On Self Testing. The machine will not start.	Re-start. If error remains, contact Struers Service.
#110	Machine found a problem during Power On Self Testing. Machine can continue. However, it is strongly recommended to contact Struers technical support. Some features may not be available.	A critical error is detected during Power-On Self Testing.	Re-start. If error remains, contact Struers Service.
#113	Water pump blocked!		Check the cooling fluid level. If the level is low, refill the cooling tank with cooling fluid. Replace the cooling fluid if it appears dirty (build-up of cutting debris). If this does not help, contact Struers Service.
#114	Machine searching for reference positions. Please wait... Don't switch machine off!	Zero positions are calibrated after each 5th start-up, or if reference position has been lost or if Emergency Stop has been activated under start-up.	Wait until the process is completed.
#117	Water pump blocked! Process halted! Clean cooling system before continuing.		Check the cooling fluid level. If the level is low, refill the cooling tank with cooling fluid. Replace the cooling fluid if it appears dirty (build-up of cutting debris). If this does not help, contact Struers Service.

*Secotom-15
Instruction Manual*

No.	Message	Explanation	Action Required
#119	Main motor overload detected! Reduce feed speed before continuing.	The cut-off wheel may be caught in the workpiece.	Move the cutting table backwards to release the cut-off wheel, reduce the feed speed and continue cutting.
		The OptiFeed feature is unable to decrease the main motor load to an acceptable level.	Manually reduce the feed speed and continue cutting.
#125	Main motor overheated! Cutting process halted! Please wait until motor temperature decreases before continuing cutting.	The temperature of the main motor has been over 150°C for more than 5sec.	Wait for the motor to cool.
#126	Main motor cannot start. Process halted! Please try to restart the machine if problem occurs after next start.		Switch Secotom off and then on. If this does not help, contact Struers Service.
#127	Main motor rotation lost. Process halted! Try to restart cutting process. Alarm register: xxxx Error register: xxxx	The cutting process has been aborted.	Make a note of the Alarm register and Error register values then restart the Cutting process. If this does not help, contact Struers Service and quote the Alarm and Error register values.
#128	Open safety lock detected. Process halted! Restart the process - do not open guard during operation!	Sensors register that the safety lock is open during cutting.	Check that the guard is closed, and the safety lock engaged. If this does not help, contact Struers Service.
#129	Searching of reference positions aborted by user. Machine cannot continue without reference positions found. Please restart the machine and wait until reference positions are scanned.	Emergency stop has been activated whilst Secotom has been scanning for zero-positions.	Restart the machine and wait until the scan for zero-positions is complete.
#130	Motor drive overloaded! Process halted! Please decrease RPM and/or feed speed before continuing cutting.	The load on the motor has caused an overload.	Decrease the RPM and/or feed speed before continuing cutting
#134	Main motor cannot reach full speed. Process halted! The cut-off wheel is probably touching the workpiece.	Cut-off wheel not able to reach required RPMs within 12 sec. A probable cause is that the cut-off wheel is already in the workpiece.	Re-position the cut-off wheel or workpiece.

*Secotom-15
Instruction Manual*

No.	Message	Explanation	Action Required
Errors			
#001	SMM not present!	Struers Memory Module isn't correctly connected to machine.	Re-start. If error remains, contact Struers Service.
#002	Inverter communication failed!	Machine isn't able to communicate with frequency inverter.	Re-start. If error remains, contact Struers Service.
#003	Joystick not connected!	Machine didn't detect joystick.	Re-start. If error remains, contact Struers Service.
#004	Mains voltage too low!	Mains voltage lower than 220V.	Check that the mains voltage corresponds to the voltage stated on the type plate on the rear of the machine. Re-start. If error remains, contact Struers Service.
#005	Problem with 24V supply voltage	DC supply voltage lower than 18V.	Re-start. If error remains, contact Struers Service.
#006	5V supplying out of range	5V power supply on PCB is lower than 4V	Re-start. If error remains, contact Struers Service.
#007	SMM read-write test failed	Communication with Struers Memory Module unsuccessful	Re-start. If error remains, contact Struers Service.
#008	Y-table motor not connected	Communication with the Y-table Stepper Motor Unit failed.	Re-start. If error remains, contact Struers Service.
#009	CAN bus critical error	Error is caused either by damage on main board CAN controller or due to wrong wiring.	Contact Struers Service.

Secotom-15
Instruction Manual

No.	Message	Explanation	Action Required
Warnings			
#001	Mains voltage too low	Mains voltage is lower than 180V.	Check that the mains voltage corresponds to the voltage stated on the type plate on the rear of the machine. Re-start. If error remains, contact Struers Service.

Error	Explanation	Action
Machine Problems		
No, or insufficient cooling fluid.	Level in the cooling fluid tank too low.	Check that there is sufficient water in the Cooling fluid tank.
	Cooling fluid nozzles blocked.	Clean the nozzles.
Water leaking.	Leak in the Cooling fluid tube.	Check the Cooling Pump Tube. Replace if necessary.
	Water overflow in the cooling fluid tank.	Remove the excess water.
	The basket for cutting debris is blocked.	Clean the basket.
Workpieces rusty.	Insufficient additive in cooling fluid.	Check the concentration of Corrozip in the cooling fluid. Follow the instructions in the Maintenance Section.
Cutting chamber rusty.	Insufficient additive in cooling fluid.	Check the concentration of Corrozip in the cooling fluid. Follow the instructions in the Maintenance Section.
	The guard is left closed after use.	Leave the guard open to let the cutting chamber dry.
Cutting chamber shows signs of corrosion.	The workpiece is made of Copper/ Copper Alloy.	Use Corrozip-Cu.

Secotom-15
Instruction Manual

Error	Explanation	Action
Cutting Problems		
Discoloration or burning of the workpiece.	The hardness of the cut-off wheel is inappropriate for the hardness / dimensions of the workpiece.	Select another wheel. Please refer to the <i>Brochures</i> for details of the range available. Alternatively, reduce rotational speed.
	Inadequate cooling.	Check the positioning of the cooling fluid nozzles. If necessary, clean the nozzles.
		Check that there is sufficient water in the Cooling fluid tank. Check the concentration of Corrozip in the cooling fluid.
Unwanted burrs.	Cut-off wheel too hard.	Select another wheel. Please refer to the <i>Brochures</i> for details of the range available. Alternatively, reduce rotational speed
	Feed speed too high at the end of the operation.	Reduce the feed speed near the end of the operation.
	Incorrect clamping of the workpiece.	Support the workpiece and clamp it on both sides. e.g. Struers' Specimen Holder CATAL, which is designed for clamping small, long workpieces on both sides.
Cutting quality differs.	Inadequate cooling.	Check the positioning of the cooling fluid nozzles. If necessary, clean the nozzles
		Check that there is sufficient water in the Cooling fluid tank.
		Check the concentration of Corrozip in the cooling fluid.

*Secotom-15
Instruction Manual*

Error	Explanation	Action
Cut-off wheel breaks.	Incorrect mounting of the cut-off wheel.	Check that the bore/centre hole has the correct diameter. The nut must be tightened properly.
	Incorrect clamping of the workpiece.	Support the workpiece and clamp it on both sides. e.g. Struers' Specimen Holder CATAL, which is designed for clamping small, long workpieces on both sides.
	Cut-off wheel is too hard.	Select another wheel. Please refer to the Brochures for details of the range available. Alternatively, reduce rotational speed.
	Feed speed is set too high.	Reduce the feed speed.
	Force level is set too high.	Reduce the Force level.
	Cut-off wheel bends on contact with the workpiece.	Make an initial cut at a lower feed speed.
The cut-off wheel wears down too quickly.	The feed speed is too high.	Reduce feed speed.
	The rotational speed is too low.	Increase rotational speed.
	Insufficient cooling.	Check that there is enough water in the Cooling fluid tank. Check the positioning of the cooling fluid nozzles. If necessary, clean the nozzles
The cut-off wheel does not cut through the workpiece.	The rotational speed is too low.	Increase rotational speed.
	Incorrect choice of cut-off wheel.	Please refer to the Brochures for details of the range available.
	Cut-off wheel worn.	Replace the cut-off wheel.

Secotom-15
Instruction Manual

Error	Explanation	Action
The workpiece breaks when clamped.	The cut-off wheel gets caught in the workpiece during cutting.	Clamp the workpiece on both sides of the cut-off wheel so that the cut stays open. e.g. Struers' Specimen Holder CATAL, which is designed for clamping small, long workpieces on both sides.
	The workpiece is brittle.	Place the workpiece between two plastic/rubber plates. Alternatively, mount the workpiece in resin. Note! Always cut brittle workpieces very carefully.
The specimen is corroded	The specimen has been left in the cutting chamber for too long.	Remove the specimen directly after cutting. Leave the cutting chamber guard open when you leave the machine.
	Insufficient additive for cooling fluid.	Check the concentration of Corrozip in the cooling fluid.

4. Service

Secotom offers extensive information about the conditions of all different components.

To reach this function:

Go to the *Maintenance* menu and select: *Service information*.

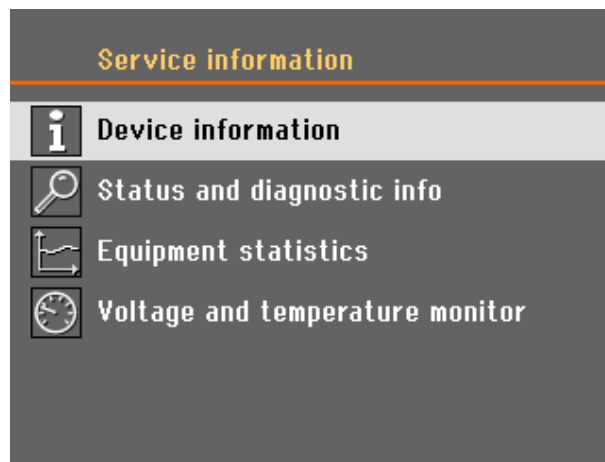

Various topics can be selected for information on the condition of the different components.

Service information can also be used in cooperation with Struers Service for remote diagnostics of the equipment.

Service information is read-only information, machine settings cannot be changed or modified.

Information on total operation time and servicing of the machine is displayed on the screen at start-up:

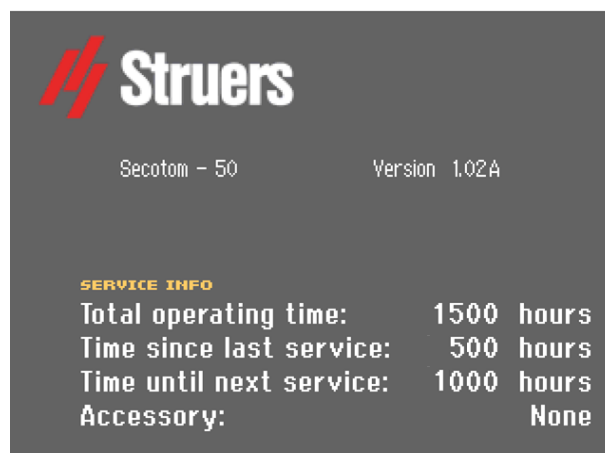

A reminder will appear after 1,400 hours operation time to remind the user that a service check should be scheduled.

After the 1,500 hours operation time has been exceeded the Service-Info will change to alert the user that the recommended service interval has been exceeded: "Service period expired!"

- Contact Struers Service to service the machine.

Service Check



NOTE:

Servicing may only be performed by a Struers engineer or a qualified technician (electromechanical, electronic, mechanical, pneumatic, etc.).

Contact Struers Service for information.

Struers recommends that a regular service check be carried out after every 1,500 hours of use.

Struers offers a range of comprehensive maintenance plans to suit the requirements of our customers. This range of services is called **ServiceGuard**.

The maintenance plans include equipment inspection, replacement of wear parts, adjustments/calibration for optimal operation, and a final functional test.

5. Spare Parts and Diagrams

For further information, or to check the availability of other replacement parts, please contact your local Struers Service department. Contact information is available on Struers.com.

Safety Related Parts of the Control System (SRP/CS)

Safety Related Part	Manufacturer / Manufacturer Description	Manufacturer Cat. no.
Interlock locking device	Schmersal Solenoid interlock	AZM 170-02ZRKA 24 VAC/DC
Frequency inverter	Omron 1x200V 1.5kW	VZAB1P5BAA
Emergency Stop button	Schlegel Latching Mushroom Head	ES Ø22 type RV
Emergency Stop contact	Schlegel Modular Contact, momentary	1 NC type MTO
Guard	Struers	15990016

Struers' Cat. No. are listed in the Spare Parts list



WARNING

Safety critical components are to be replaced after a maximum lifetime of 20 years.
Contact Struers Service for information.



NOTE:

The guard must be replaced after a lifetime of 5 years.

Replacement of Safety critical components can only be performed by a Struers engineer or a qualified technician (electromechanical, electronic, mechanical, pneumatic, etc.).

Safety critical components may only be replaced by components with at least the same safety level.

Contact Struers Service for information.

Spare Parts List

Spare Part	EI.Ref.	Cat no:
Interlock locking device	YS1	2SS00019
Frequency inverter	A3	2PU12150
Emergency Stop button	SB1	2SA10400
Emergency Stop contact	SB1	2SB10071
Guard	-	15990016

Circuits and Diagrams

Block Diagram, Secotom.....	15993050
Circuit Diagram, Secotom (3 pages)	15993100
Water Diagram, Secotom.....	15991005

See the following pages.

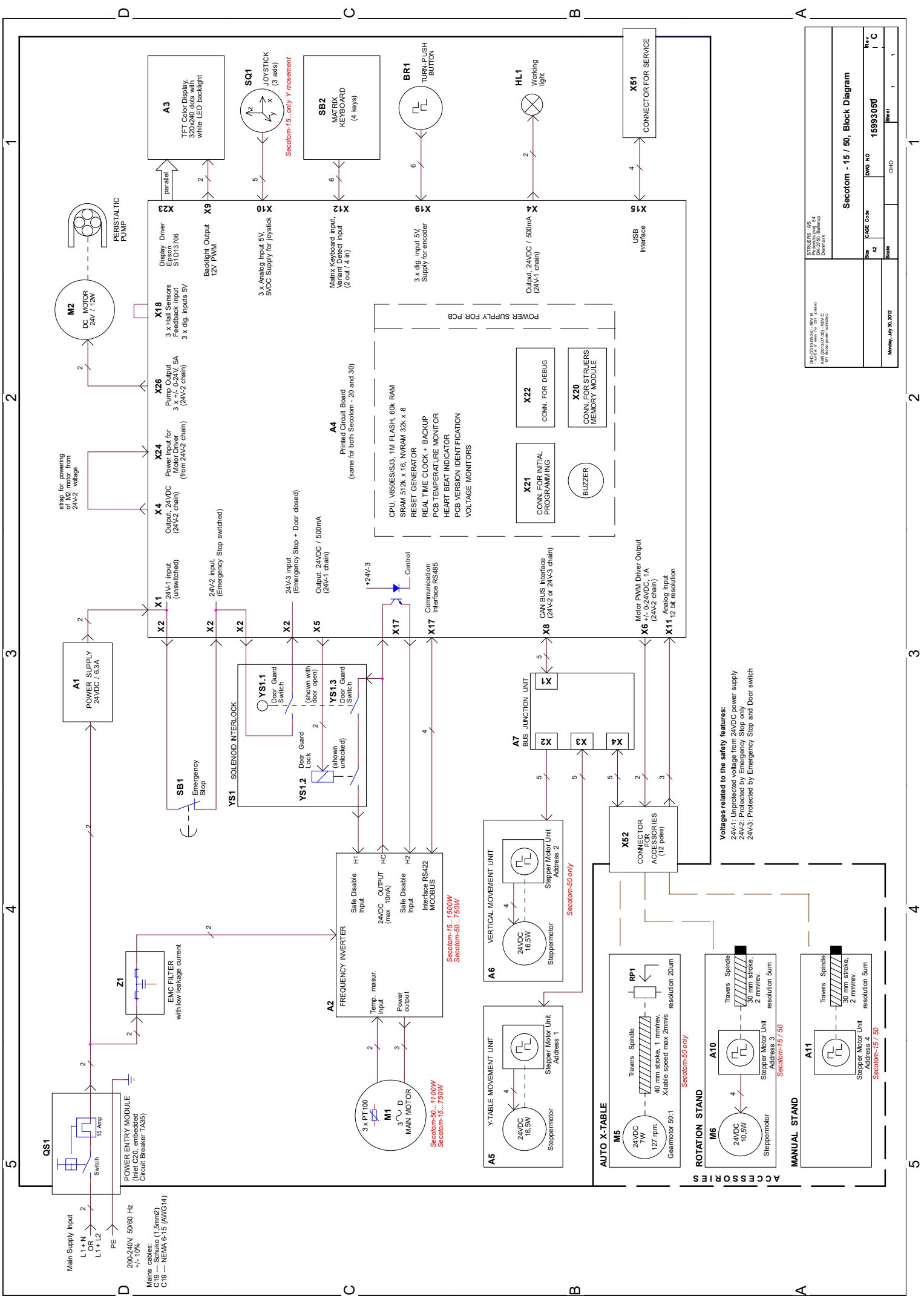

OAG 15090002/01/001/15 APL 000202/02/30/1505 C 010 1000 power 000002		REV. NO. 15593087 DATE 15/05/2015 DRAWN BY: S. B. B.	
Sheet	42	Page No	1
Scale		OHG	1
Secotom - 15 / 50, Block Diagram			
Rev.	C	Sheet	1

Voltages related to the safety features:
 24V-1: Unprotected voltage from 24VDC power supply
 24V-2: Protected by Emergency Stop only
 24V-3: Protected by Emergency Stop and Door switch

Secotom-50 only

Secotom-15/50

Secotom-15/50

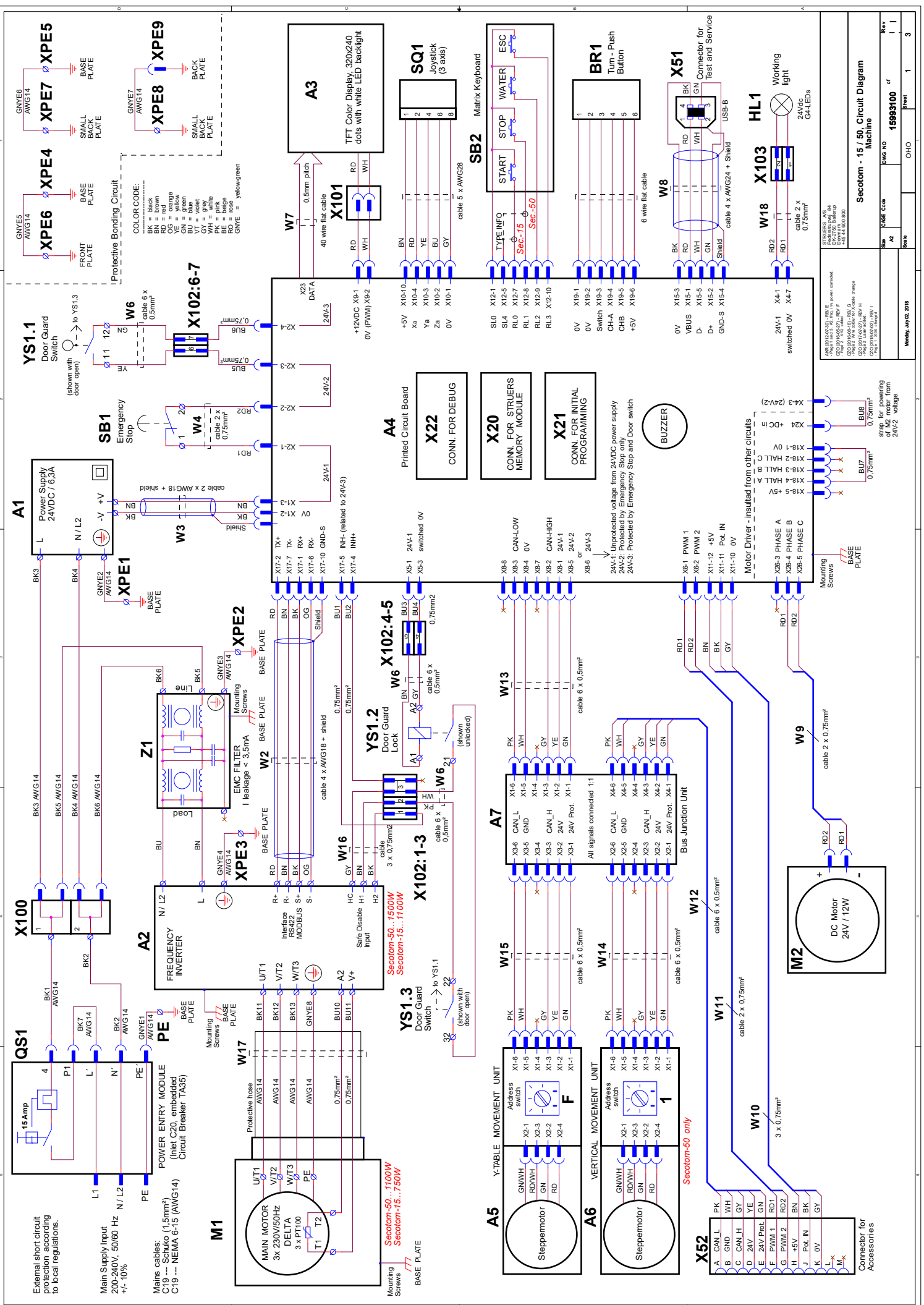

Protective Bonding Circuit

GNVE5	AWG14	XPE6
GNVE6	AWG14	XPE7
GNVE7	AWG14	XPE8
GNVE8	AWG14	XPE9

COLOR CODE:
BK = black
BN = red
OG = orange
GN = green
BU = blue
GY = grey
WH = white
BE = beige
RVE = rose
GVE = yellowgreen

External short circuit protection according to local regulations.

Main supply input
200-240V, 50/60 Hz
+/- 10%

Mains cables:
C19 --- Schuko (1,5mm²)
C19 --- NEMA 6-15 (AWG14)

M1 MAIN MOTOR
3x 230V/50Hz
3x DELTA
3x PTT00

PE POWER ENTRY MODULE
(Inlet C20, embedded
Circuit Breaker TA35)

A2 FREQUENCY INVERTER

Z1 EMC FILTER
I leakage < 3,5mA

A1 Power Supply
24VDC / 6,3A

SB1 Emergency Stop

A4 Printed Circuit Board

X22 CONN. FOR DEBUG

X20 CONN. FOR STRUERS MEMORY MODULE

X21 CONN. FOR INITIAL PROGRAMMING

A5 Y-TABLE MOVEMENT UNIT

A6 VERTICAL MOVEMENT UNIT

A7 Bus Junction Unit

All signals connected 1:1

M2 DC Motor
24V / 12W

A3 TFT Color Display, 320x240 dots with white LED backlight

SB2 Matrix Keyboard

BR1 Turn - Push Button

HL1 Working light
24VDC
G4-LEDs

STREIBER: AVS
Produktionsbereich für
Produktentwicklung
C20,0311402/01 Rev. A
C20,0311402/02 Rev. B
C20,0311402/03 Rev. H
C20,0311402/04 Rev. I
Page 1 / 3001 (master)

Secotom - 15 / 50 Circuit Diagram
Machine

Size	DATE Code	Draw no	Rev
A2		15983100	1
Scale			
Drawn		OHO	1
Checked			3

Monday, July 20, 2018

AUTO X-TABLE

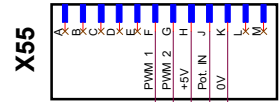
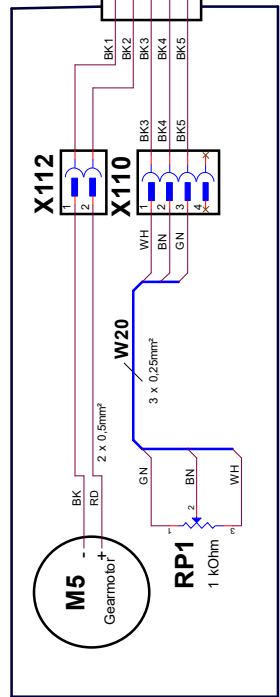

ROTATION STAND

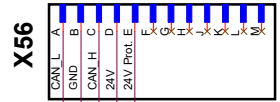
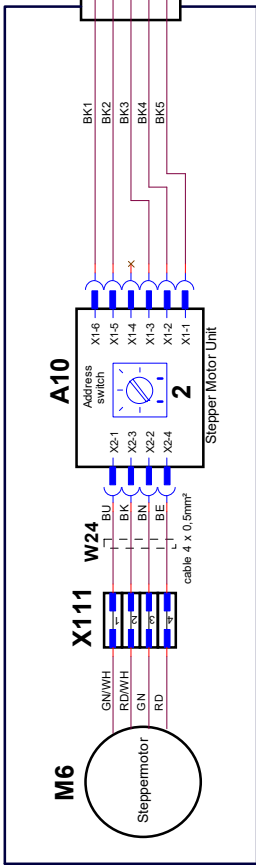

MANUAL STAND

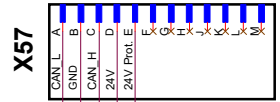
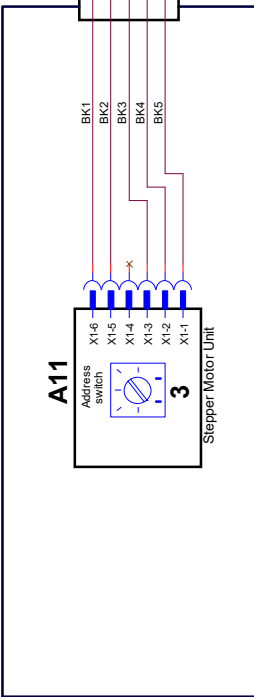

LASER

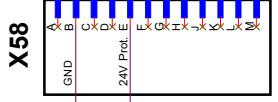
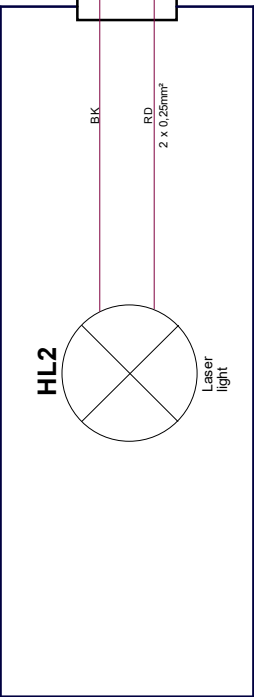

AMR 03/16/07/02/1 REV E
 - Page 1 and 2: 24V line for power connect
 - Page 3: CAN L, CAN H, CAN P
 - Page 4: CAN L, CAN H, CAN P
 - Page 5: CAN L, CAN H, CAN P
 - Page 6: CAN L, CAN H, CAN P
 - Page 7: CAN L, CAN H, CAN P
 - Page 8: CAN L, CAN H, CAN P
 - Page 9: CAN L, CAN H, CAN P
 - Page 10: CAN L, CAN H, CAN P
 - Page 11: CAN L, CAN H, CAN P
 - Page 12: CAN L, CAN H, CAN P
 - Page 13: CAN L, CAN H, CAN P
 - Page 14: CAN L, CAN H, CAN P
 - Page 15: CAN L, CAN H, CAN P
 - Page 16: CAN L, CAN H, CAN P
 - Page 17: CAN L, CAN H, CAN P
 - Page 18: CAN L, CAN H, CAN P
 - Page 19: CAN L, CAN H, CAN P
 - Page 20: CAN L, CAN H, CAN P
 - Page 21: CAN L, CAN H, CAN P
 - Page 22: CAN L, CAN H, CAN P
 - Page 23: CAN L, CAN H, CAN P
 - Page 24: CAN L, CAN H, CAN P
 - Page 25: CAN L, CAN H, CAN P
 - Page 26: CAN L, CAN H, CAN P
 - Page 27: CAN L, CAN H, CAN P
 - Page 28: CAN L, CAN H, CAN P
 - Page 29: CAN L, CAN H, CAN P
 - Page 30: CAN L, CAN H, CAN P
 - Page 31: CAN L, CAN H, CAN P
 - Page 32: CAN L, CAN H, CAN P
 - Page 33: CAN L, CAN H, CAN P
 - Page 34: CAN L, CAN H, CAN P
 - Page 35: CAN L, CAN H, CAN P
 - Page 36: CAN L, CAN H, CAN P
 - Page 37: CAN L, CAN H, CAN P
 - Page 38: CAN L, CAN H, CAN P
 - Page 39: CAN L, CAN H, CAN P
 - Page 40: CAN L, CAN H, CAN P
 - Page 41: CAN L, CAN H, CAN P
 - Page 42: CAN L, CAN H, CAN P
 - Page 43: CAN L, CAN H, CAN P
 - Page 44: CAN L, CAN H, CAN P
 - Page 45: CAN L, CAN H, CAN P
 - Page 46: CAN L, CAN H, CAN P
 - Page 47: CAN L, CAN H, CAN P
 - Page 48: CAN L, CAN H, CAN P
 - Page 49: CAN L, CAN H, CAN P
 - Page 50: CAN L, CAN H, CAN P
 - Page 51: CAN L, CAN H, CAN P
 - Page 52: CAN L, CAN H, CAN P
 - Page 53: CAN L, CAN H, CAN P
 - Page 54: CAN L, CAN H, CAN P
 - Page 55: CAN L, CAN H, CAN P
 - Page 56: CAN L, CAN H, CAN P
 - Page 57: CAN L, CAN H, CAN P
 - Page 58: CAN L, CAN H, CAN P
 - Page 59: CAN L, CAN H, CAN P
 - Page 60: CAN L, CAN H, CAN P
 - Page 61: CAN L, CAN H, CAN P
 - Page 62: CAN L, CAN H, CAN P
 - Page 63: CAN L, CAN H, CAN P
 - Page 64: CAN L, CAN H, CAN P
 - Page 65: CAN L, CAN H, CAN P
 - Page 66: CAN L, CAN H, CAN P
 - Page 67: CAN L, CAN H, CAN P
 - Page 68: CAN L, CAN H, CAN P
 - Page 69: CAN L, CAN H, CAN P
 - Page 70: CAN L, CAN H, CAN P
 - Page 71: CAN L, CAN H, CAN P
 - Page 72: CAN L, CAN H, CAN P
 - Page 73: CAN L, CAN H, CAN P
 - Page 74: CAN L, CAN H, CAN P
 - Page 75: CAN L, CAN H, CAN P
 - Page 76: CAN L, CAN H, CAN P
 - Page 77: CAN L, CAN H, CAN P
 - Page 78: CAN L, CAN H, CAN P
 - Page 79: CAN L, CAN H, CAN P
 - Page 80: CAN L, CAN H, CAN P
 - Page 81: CAN L, CAN H, CAN P
 - Page 82: CAN L, CAN H, CAN P
 - Page 83: CAN L, CAN H, CAN P
 - Page 84: CAN L, CAN H, CAN P
 - Page 85: CAN L, CAN H, CAN P
 - Page 86: CAN L, CAN H, CAN P
 - Page 87: CAN L, CAN H, CAN P
 - Page 88: CAN L, CAN H, CAN P
 - Page 89: CAN L, CAN H, CAN P
 - Page 90: CAN L, CAN H, CAN P
 - Page 91: CAN L, CAN H, CAN P
 - Page 92: CAN L, CAN H, CAN P
 - Page 93: CAN L, CAN H, CAN P
 - Page 94: CAN L, CAN H, CAN P
 - Page 95: CAN L, CAN H, CAN P
 - Page 96: CAN L, CAN H, CAN P
 - Page 97: CAN L, CAN H, CAN P
 - Page 98: CAN L, CAN H, CAN P
 - Page 99: CAN L, CAN H, CAN P
 - Page 100: CAN L, CAN H, CAN P

Secom - 16 / 50, Circuit Diagram Accessories	Page NO	Rev
15993100	1	1
15993100	2	3
15993100	3	1

Monday, July 02, 2018

YS1.1
Door Guard
Switch
(shown with
door open)

SB1
Emergency Stop push button

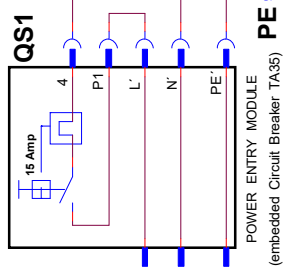

External short circuit protection according to local regulations.
Main Supply Input 200-240V, 50/60 Hz +/- 10%

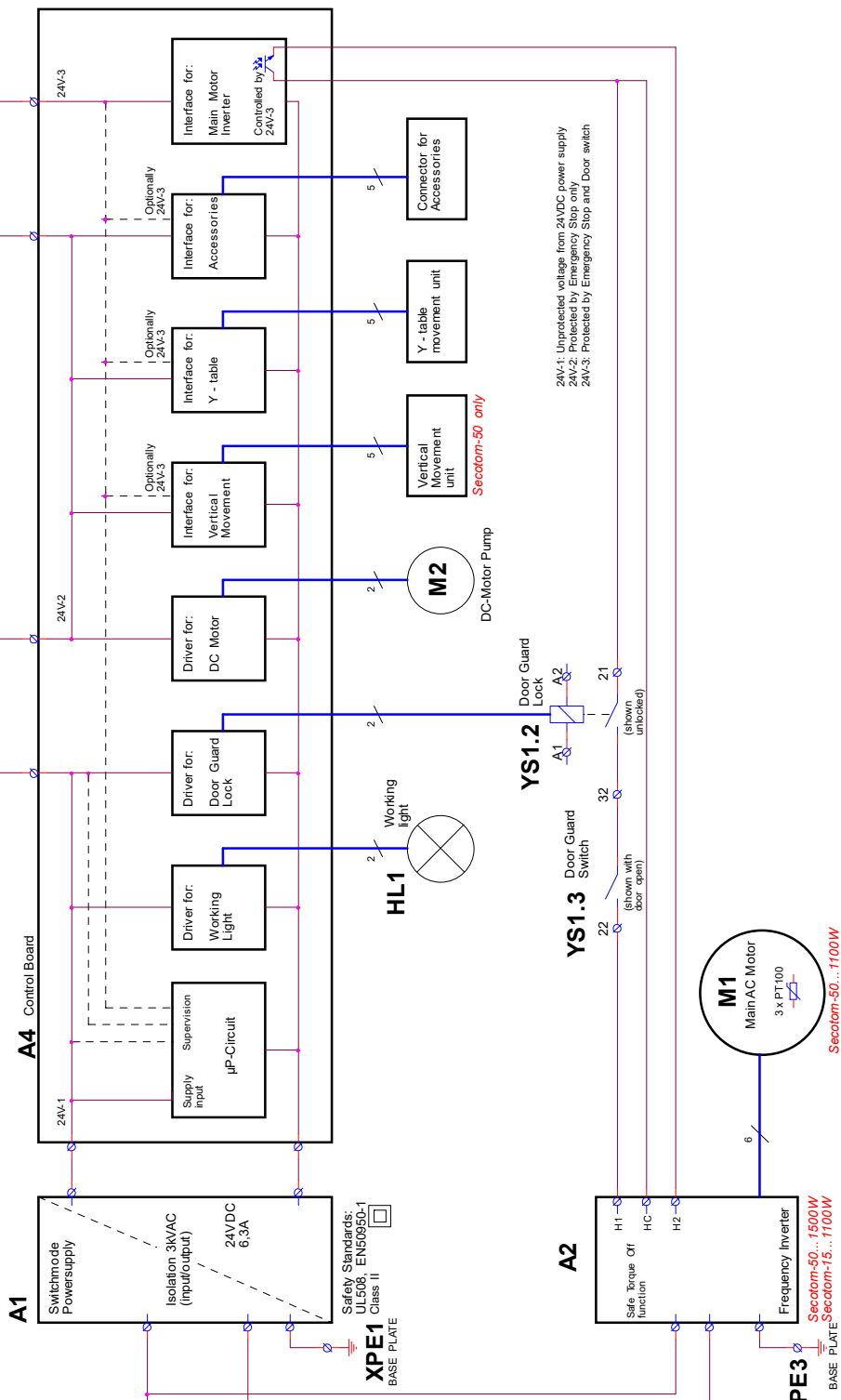

A1
Switchmode Powersupply
Isolation 3kV/AC (input/output)
24VDC 6.3A
Safety Standards:
UL508, EN50950-1
Class II
XPE1
BASE PLATE

A2
Safe Torque Off function
Frequency Inverter
XPE3
BASE PLATE
Main AC Motor
3 x PT100
Secotom-50...1100W
Secotom-15...750W

A4 Control Board
24V-1
24V-2
24V-3
24V-3
24V-3
24V-3

HL1
Working light

YS1.2
Door Guard Lock
A1 A2

YS1.3
Door Guard Switch
22 (shown with door open)
32 (shown with door open)

24V-1: Unprotected voltage from 24VDC power supply
24V-2: Protected by Emergency Stop only
24V-3: Protected by Emergency Stop and Door switch

Vertical Movement unit
Secotom-50 only

M2
DC-Motor Pump

M1
Main AC Motor
3 x PT100
Secotom-50...1100W
Secotom-15...750W

ITZINGER AG Industriestraße 20 4110 Leoben, Austria T +43 (0) 3772 2100 F +43 (0) 3772 2100 E leoben@itzinger.com www.itzinger.com			
Project No. CPU 5919652741, REV.F CPU 5919651841, REV.G CPU 5919652741, REV.H Page 2: Lower level	CAD Code 16983100	Date 15.09.2010	Rev 3
Model: JAY 02.2010		Sheet 3	of 3

**Secotom - 15 / 50, Circuit Diagram
Safety Related Circuits**

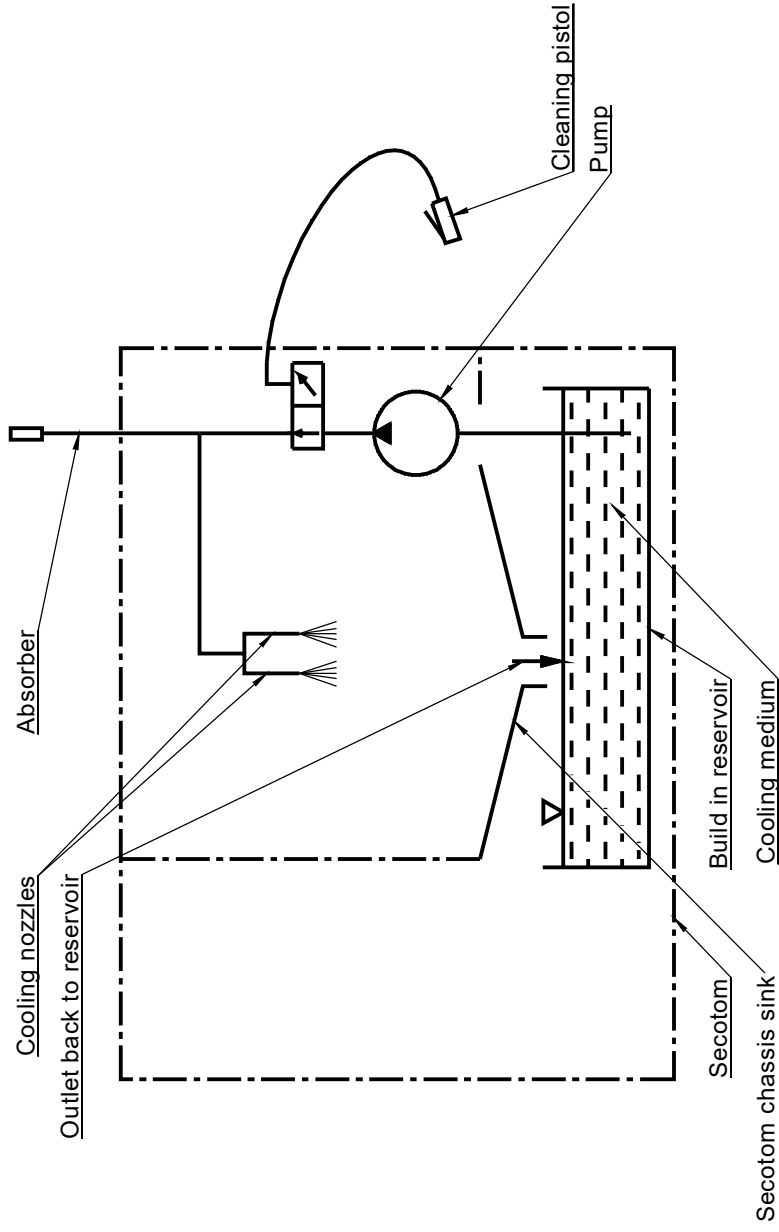

A	2018-11-07	Release	SCA	2018-11-07	RSZ
Revision	Crea. date yyyy-mm-dd	Revision description	Draw. Init	Appr. date yyyy-mm-dd	Appr. Init
		Material	Format: A3	Tolerance: DS/ISO 2768-	
			Scale: 1:1	Weight:	g
 StuERS P. Industriepark 84 4700 Venlo, Balneario, C. Capenhagen Phone: +49 44 600 800 Fax: +49 44 600 804		ID: 15991005 Water diagram Description:		Rev: A	

5. Legal and Regulatory

FCC Notice

This equipment has been tested and found to comply with the limits for a Class A digital device, pursuant to Part 15 of the FCC Rules. These limits are designed to provide reasonable protection against harmful interference when the equipment is operated in a commercial environment. This equipment generates, uses, and can radiate radio frequency energy and, if not installed and used in accordance with the Instruction Manual, may cause harmful interference to radio communications. Operation of this equipment in a residential area is likely to cause harmful interference in which case the user will be required to correct the interference at his own expense.

Pursuant to Part 15.21 of the FCC Rules, any changes or modifications to this product not expressly approved by Struers ApS could cause harmful radio interference and void the user's authority to operate the equipment.

EN ISO 13849-1:2015

All SRP/CS are limited to a lifetime of 20 years. After expiration of this period, all components must be replaced.

6. Technical Data

Subject		Specifications
Cutting	Motor	0.8 kW
	<i>Cutting Power</i>	
	S1	0.8 kW
	S3	1.0 kW
	Cut-off wheels	ø75 mm (3") - 203 mm (8")
	<i>Output axle</i>	
	Rotational speed:	300 - 5,000 rpm (in steps of 100 rpm)
	Diameter:	12.7 / 22 mm (0.5 / 0.86")
Positioning & Feed	Positioning range (of cut-off wheel)	0 – 40 mm (0 – 1.6")
	Positioning range (of cutting table)	0 – 190 mm (0 – 7.5") (in steps of 0.1 mm)
	Max. positioning speed of table	20 mm/s / 0.79"/s
	Feed Speed range of table	0.005 – 3,000 mm/s (0.2 – 120 Mil/s) (in steps of 0.005 mm/s / 0.2 Mil/s)
Cutting Table dimensions	Width	258 mm / 10.2"
	Depth	184 mm / 7.2"
	T-slots	8 mm / 0.3"
Cutting Capacity		70 mm dia. or 165 x 50 mm 2.8" dia. or 6.5 x 2"
Recirculation Cooling Tank	Capacity:	4.75 l / 1.25 gallon
	Flow:	1.6 l/min / 0.4 gallon/min
Noise level⁴	A-weighted sound emission pressure level at workstations	L _{PA} = 66 dB(A) (measured value) Uncertainty K = 4 dB(A) Measurements made in accordance with EN ISO 11202.

⁴ Noise level: The figures quoted are emission levels and are not necessarily safe working levels. While there is a correlation between the emission and exposure levels, this cannot be used reliably to determine whether or not further precautions are required. Factors that influence the actual level of exposure of the workforce include characteristics of the work room, the other sources of noise, etc., i.e. the number of machines and other adjacent processes. Also, the permissible exposure level can vary from country to country. This information, however, will enable the user of the machine to make a better evaluation of the hazard and risk.

Secotom-15
Instruction Manual

Subject		Specifications
Operating environment	Surrounding temperature	5-40 °C / 41-104 °F
	Humidity	0-85 % RH non-condensing
Storage Conditions	Temperature	-25 – 55 °C / -13 – 131 °F
Supply	Voltage / frequency	200-240 V / 50-60 Hz
	Power inlet	1-phase (N+L1+PE) or 2-phase (L1+L2+PE) The electrical installation must comply with "Installation Category II".
	Power, nominal load	720 W
	Power, idle	13 W
	Current, nom.	4 A
	Current, max.	11.7 A
EU Directives	Please refer to the Declaration of Conformity	
Stop Mechanisms	Emergency stop	Designed to comply with a minimum of EN60204-1, Stop Category 0
Exhaust	Dimension	50 mm / 2" dia. Minimum capacity: 30 m ³ /h / 1,060 ft ³ /h at 0 mm / 0" water gauge.
Dimensions	Height:	44 cm / 17.3" (guard closed) 106 cm / 41.5" (guard open)
	Width	64 cm / 25.4"
	Depth	78.5 cm / 30.9" (with plug)
	Weight	68 kg / 150 lbs

Secotom-15/-50, Pre-Installation Checklist

Read the Installation instructions in the Instruction Manual *before* installing the machine.

Installation Requirements

- Crane and 2 lifting straps¹
- Screwdriver/ bit: TX30 , PH2  and H4 

Required Accessories and Consumables (ordered separately)
(Please refer to the [Secotom Brochure](#) and the [Struers Consumables Catalogue](#) for details of the range available).

Recommended
Exhaust system: 30 m³/h / 1,060 ft³/h at 0 mm/0" water gauge

Crating Specifications

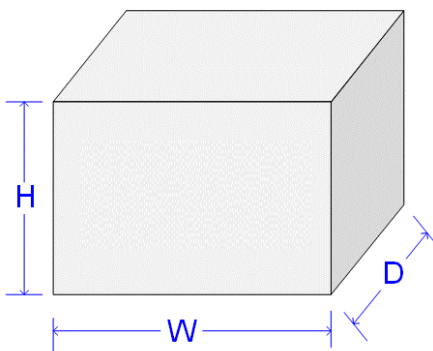

Secotom-15	
H	88 cm / 34.6"
W	92 cm / 36"
D	92 cm / 36"
Weight	100 kg / 220 lbs

Secotom-50	
H	73 cm / 28.7"
W	91 cm / 35.8"
D	91 cm / 35.8"
Weight	110 kg / 243 lbs

¹ Straps must be approved of at least twice the weight of the machine.

Unpacking

- Carefully open and remove the sides and the top of the packing crate.
- Remove the transport brackets securing the machine to the pallet.

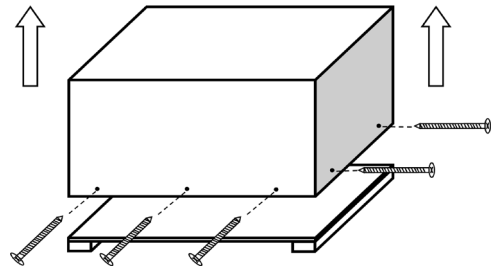

Location

- The machine must be placed close to the power supply.
- The machine is designed to be placed on a rigid, stable workbench with a horizontal surface.

Recommended dimensions:

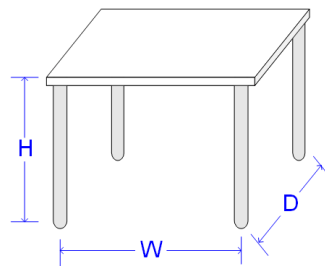

Height: Recommended 80 cm / 31.5"
Width: 92 cm / 36.2"
Depth: 90 cm / 35.4"

Recommended workbench dimensions. Height of table (H) follows local preferences.

- To facilitate easy access for service technicians, allow sufficient space around the machine.



HINT:

A table unit designed for Struers' table top machines is available as an accessory Cat. No. 06266101.

Recommended Space

Front: Recommended space at the front: 100 cm / 40".

Rear: The machine may be placed against a wall.

- Check there is enough room behind the table for the cover to be opened fully (see illustration).
- Check there is approx. 15 cm / 5.9" behind the machine for the exhaust hose.

Dimensions

Front

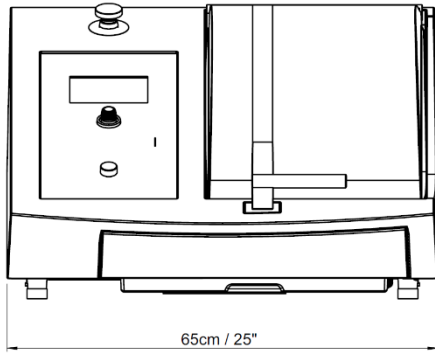

Side

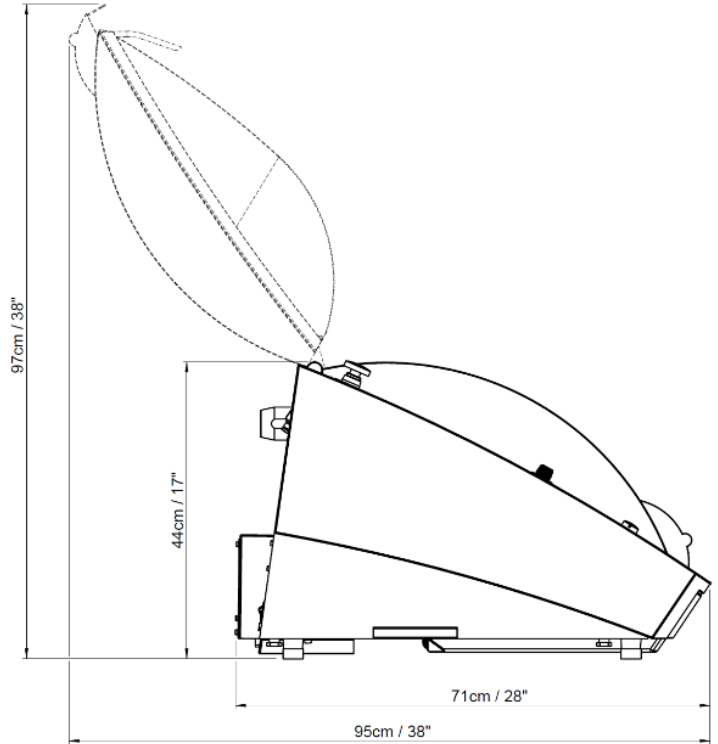

Centre of Gravity

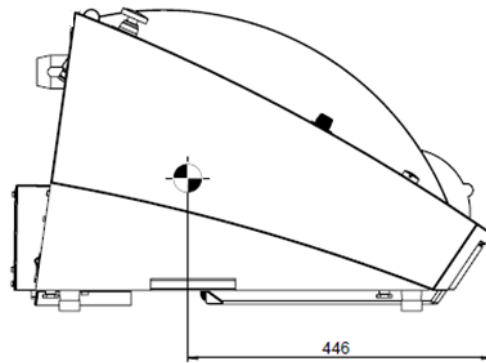
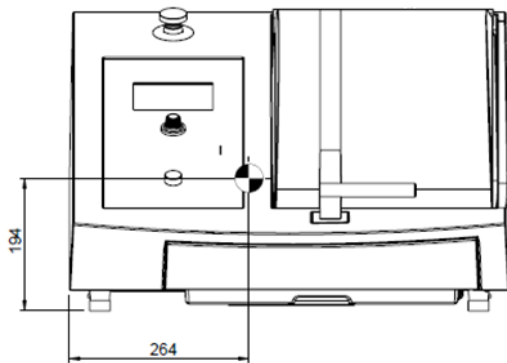

Lifting



NOTE:

Do not lift Secotom using the light grey body.
Remove the recirculation tank before lifting Secotom.
Always lift from underneath the machine.

With a crane

A crane and 2 lifting straps are required to lift the machine off the shipment pallet.
A lifting bar is recommended so that the two straps are kept apart below the lifting point.

- Remove the recirculation tank.
- Place the two lifting straps under Secotom.
 - Position the straps under Secotom, so that they are on the inside of the feet. See drawing.

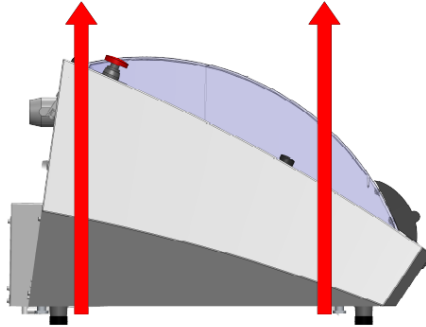

- Lift Secotom onto the table.
- Lift the front of Secotom and carefully move into place.

Power Supply

The machine shipped with 2 types of Mains cables (length 2.5 m/ 8.2').

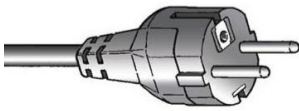

The 2-pin (European Schuko) plug is for use on single-phase connections. If the plug supplied on this cable is not approved in your country, then the plug must be replaced with an approved plug.

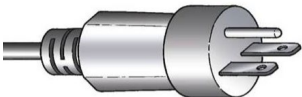

The 3-pin (North American NEMA 6-15P) plug is for use on 2-phase connections. If the plug supplied on this cable is not approved in your country, then the plug must be replaced with an approved plug.

Electrical data

	Secotom-15	Secotom-50
Voltage / frequency	200-240 V / 50-60 Hz	
Power inlet	1-phase (N+L1+PE) or 2-phase (L1+L2+PE) The electrical installation must comply with "Installation Category II".	
Power, nominal load	720 W	1060W
Power, idle	13 W	13W
Current, nom.	4 A	5.3 A
Current, max.	11.7 A	14.8 A

Safety Functions

Stop Mechanisms

	Designed to comply with a minimum of
Emergency stop	EN60204-1, Stop Category 0

Water Supply

Required

Option

Cooling water is supplied from the integrated recirculation unit (capacity 4.75 l / 1.25 gallon). A kit for connection to an external recirculation unit is available as an optional accessory.

Water outlet – Drain

Required

Option

The machine is supplied with a small drain hose, which directs the cooling water into the recirculation unit.

Compressed air

Required

Option

Not required.

Exhaust

Required

Option

Recommended

Minimum capacity: 30 m³/h / 1,060 ft³/h at 0mm /0" water gauge.

Exhaust connection:

The machine is supplied with an exhaust hose 1.5 m / 4.9' long with a diameter 50 mm / 2"

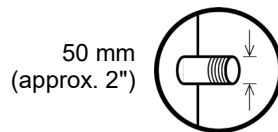

Ambient Conditions

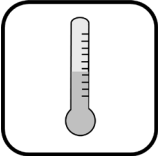

5 - 40 °C
41 - 104 °F



Max. 85 % RH non condensing

Accessories & Consumables

Please refer to the [Secotom Brochure](#) and the [Struers Consumables Catalogue](#) for details of the range available.

Consumables

The use of Struers consumables is recommended.
Other products (e.g. coolants) may contain aggressive solvents, which dissolve e.g. rubber seals. The warranty may not cover damaged machine parts (e.g. seals and tubes), where the damage can be directly related to the use of non-Struers consumables.

Contents of the Declaration of Conformity

Manufacturer

Struers ApS
Pederstrupvej 84
DK-2750 Ballerup, Denmark
Telephone +45 44 600 800

Herewith declares that

<i>Name:</i>	Secotom-15/-50
<i>Function:</i>	Precision cut-off machine
<i>Type:</i>	05996127, 05996227

fulfils all the relevant provisions of the:

**Machinery Directive
2006/42/EC**

according to the following standard(s):
EN ISO 12100:2010, EN 60204-1:2006/AC:2010, EN ISO 14120:2015.

and is in conformity with the:

**EMC Directive
2014/30/EU**

according to the following standard(s):
EN 61000-6-2:2005, EN 61000-6-4:2007/A1:2011, EN 61326-1:2013.

**RoHS Directive
2011/65/EU**

according to the following standard(s):
EN 50581:2012.

Supplementary Information

The equipment complies with the following standards:
UL508, NFPA70:2014, NFPA79: 2012, FCC 47 CFR part 15.

The above has been declared according to the global approach, module A.

Authorized to compile the Technical File:

Klavs Tvenge
Director of Business Development
Struers ApS
Pederstrupvej 84
DK-2750 Ballerup, Denmark



Pederstrupvej 84
DK-2750 Ballerup
Denmark