

Tegramin-20

Instruction Manual

Original Instructions



CE

Doc. no.: 16017025-02_C_en
Date of release: 2024.10.07

Copyright

The contents of this manual are the property of Struers ApS. Reproduction of any part of this manual without the written permission of Struers ApS is not allowed.

All rights reserved. © Struers ApS.

Table of Contents

| | |
|--|-----------|
| 1 About this manual | 6 |
| 1.1 Accessories and consumables | 6 |
| 2 Safety | 6 |
| 2.1 Intended use | 6 |
| 2.2 Tegramin-20 safety precautions | 7 |
| 2.2.1 Read carefully before use | 7 |
| 2.3 Safety messages | 8 |
| 2.4 Safety messages in this manual | 9 |
| 3 Get started | 11 |
| 3.1 Device description | 11 |
| 3.2 Overview | 13 |
| 3.3 Emergency stop | 17 |
| 4 Installation | 17 |
| 4.1 Unpack the machine | 17 |
| 4.2 Check the packing list | 18 |
| 4.3 Lift the machine | 18 |
| 4.4 Location | 20 |
| 4.5 Power supply | 21 |
| 4.5.1 Single-phase supply | 22 |
| 4.5.2 2-phase supply | 22 |
| 4.5.3 Connection to the machine | 22 |
| 4.6 Water supply and water outlet | 22 |
| 4.6.1 Connect the machine to the water supply | 22 |
| 4.6.2 Connect the machine to the waste water outlet | 23 |
| 4.6.3 Install the shift valve - Optional | 23 |
| 4.6.4 Adjust the water flow | 24 |
| 4.7 Recirculation unit | 24 |
| 4.7.1 Connect the recirculation unit to the water inlet | 25 |
| 4.7.2 Connect the recirculation unit to the water outlet | 25 |
| 4.7.3 Connect the communication cable | 26 |
| 4.8 Compressed air | 26 |
| 4.9 External exhaust system | 26 |
| 4.10 Mount the dosing modules | 27 |
| 4.11 Mount the preparation disc | 28 |

| | |
|--|-----------|
| 4.12 Noise | 29 |
| 5 Transport and storage | 29 |
| 5.1 Transport | 29 |
| 5.2 Long-term storage or shipping | 30 |
| 6 Configuration | 30 |
| 6.1 Prepare the device | 30 |
| 6.1.1 Control panel functions | 30 |
| 6.1.2 Start the machine the first time | 32 |
| 6.1.3 The display | 33 |
| 6.1.4 Sound signals | 34 |
| 6.1.5 Edit values | 35 |
| 6.2 Change the language | 36 |
| 6.3 Change the settings | 37 |
| 6.4 Operation mode | 38 |
| 6.5 New pass code | 39 |
| 6.6 Bottle configuration | 39 |
| 6.7 Set up the preparation process | 42 |
| 6.7.1 Select a preparation mode | 42 |
| 6.7.2 Select a preparation method | 43 |
| 6.7.3 Create a preparation method | 45 |
| 6.7.4 Modify a preparation method | 48 |
| 6.7.5 Set the dosing levels | 49 |
| 6.7.6 Lock and unlock a preparation method | 50 |
| 6.8 Reset functions | 51 |
| 6.8.1 Reset methods | 52 |
| 6.8.2 Reset configuration | 52 |
| 7 Operate the device | 53 |
| 7.1 Start the preparation process | 53 |
| 7.2 Stop the process | 53 |
| 7.3 The spin function | 54 |
| 7.4 The specimen mover | 54 |
| 7.4.1 Mount the specimens in a mover plate | 54 |
| 7.4.2 Insert a specimen mover plate | 54 |
| 7.4.3 Lower the specimen mover head | 54 |
| 7.4.4 Adjust the height of the specimen mover plate | 55 |
| 7.4.5 Adjust the horizontal position of the specimen mover plate | 56 |
| 7.4.6 Recommendations for grinding single specimens | 56 |
| 7.5 Manual preparation | 57 |

| | |
|--|-----------|
| 8 Maintenance and service | 58 |
| 8.1 Clean the machine | 59 |
| 8.1.1 General cleaning | 59 |
| 8.2 Daily | 59 |
| 8.2.1 Clean the bowl | 59 |
| 8.3 Weekly | 60 |
| 8.3.1 Clean the tubes | 60 |
| 8.3.2 Clean the specimen mover head | 61 |
| 8.3.3 Empty the water/oil filter | 62 |
| 8.4 Annually | 62 |
| 8.4.1 Test the safety devices | 62 |
| 8.5 When necessary | 63 |
| 8.5.1 Calibrate pump capacity | 63 |
| 8.5.2 Adjust the tube cleaning time | 66 |
| 8.5.3 Change the tubes | 67 |
| 8.6 The Service information menu | 69 |
| 8.7 Spare parts | 70 |
| 8.8 Service and repair | 70 |
| 9 Disposal | 70 |
| 10 Troubleshooting | 71 |
| 10.1 Grinding and polishing problems | 71 |
| 10.2 Error messages | 73 |
| 11 Technical data | 82 |
| 11.1 Technical data | 82 |
| 11.2 Safety Related Parts of the Control System (SRP/CS) | 85 |
| 11.3 Diagrams | 85 |
| 11.4 Legal and regulatory information | 90 |
| 12 Manufacturer | 90 |
| Declaration of Conformity | 91 |

1 About this manual

**CAUTION**

Struers equipment must only be used in connection with and as described in the Instruction Manual supplied with the equipment.

**Note**

Read the Instruction Manual carefully before use.

**Note**

If you want to view specific information in detail, see the online version of this manual.

1.1 Accessories and consumables

Accessories

For information about the available range, see:

- [The Tegramin brochure](https://www.struers.com) (<https://www.struers.com>).

Consumables

The use of Struers consumables is recommended.

Other products may contain aggressive solvents, which dissolve e.g. rubber seals. The warranty may not cover damaged machine parts (e.g. seals and tubes), where the damage can be directly related to the use of consumables not supplied by Struers.

For information about the available range, see:

- The Struers Consumables Catalogue (via <https://www.struers.com>)

2 Safety

2.1 Intended use

Tegramin-20 and Tegramin-20 with cover

The machine is for use in a professional working environment (e.g. a materialographic laboratory).

The machine is designed to be used only with Struers consumables specifically designed for this purpose and this type of machine.

The machine is for professional manual or semi-automatic materialographic preparation (grinding or polishing) of materials for further materialographic inspection.

The machine must be operated only by skilled/trained personnel.

Do not use the machine for the following

Preparation (grinding or polishing) of materials other than solid materials suitable for materialographic studies.

The machine must not be used for any type of explosive and/or flammable material, or materials which are not stable during machining, heating or pressure.

Model

Tegramin-20

Tegramin-20 with cover

Tegramin-20 with three dosing pumps

Tegramin-20 with cover and three dosing pumps

2.2 Tegramin-20 safety precautions



2.2.1 Read carefully before use

1. Ignoring this information and mishandling of the equipment can lead to severe bodily injuries and material damage.
2. The machine must be installed in compliance with local safety regulations. All functions on the machine and any connected equipment must be in working order.
3. Make sure that the actual electrical power supply voltage corresponds to the voltage stated on the name plate of the machine. The machine must be earthed (grounded). Follow local regulations. Always switch off the electrical power supply and remove the plug or power cable before dismantling the machine or installing additional components.
4. The operator must read the safety precautions and Instruction Manual, as well as relevant sections of the manuals for any connected equipment and accessories. The operator must read the Instruction Manual and, where applicable, the Safety Data Sheets for the applied consumables.
5. This machine must be operated and maintained only by skilled/trained personnel.
6. The machine must always be used with the splash guard in place.
7. The machine must be placed on a safe and stable table with an adequate working height. The table must be able to carry at least the weight of the machine and the accessories.
8. The machine must be placed on a safe and stable table with an adequate working height. The table must be able to carry at least the weight of the machine and the accessories.
9. Connect the machine to a cold water tap. Make sure that the water connections are leak-proof and that the water outlet is working.
10. Struers recommends that the main water supply is shut off or disconnected if the machine is to be left unattended.
11. Consumables: only use consumables specifically developed for use with this type of materialographic machine. Alcohol-based consumables: follow the current safety rules for handling, mixing, filling, emptying, and disposing of alcohol-based liquids.

12. When the disc is rotating, make sure your hands are kept completely clear of its periphery and out of the splash bowl. When you perform manual grinding or polishing, be careful not to touch the disc. Never try to collect a specimen while the disc is still rotating. (models without cover)
13. Wear suitable gloves to protect fingers from abrasives and warm/sharp specimens.
14. Do not touch the specimen holder or specimen mover when moving them downwards.
15. When working at machines with rotating parts, take care to prevent clothes and/or hair from being caught by the rotating parts. Wear appropriate safety clothing.
16. If you observe malfunctions or hear unusual noises, switch off the machine and call technical service.
17. The machine must be disconnected from the electrical power supply before any service. Wait 5 minutes until residual potential on the capacitors is discharged.
18. Do not switch the machine on and off more than once every three minutes. Damage to the electrical components could occur.
19. In case of fire, alert bystanders, the fire brigade and cut power. Use a powder fire extinguisher. Do not use water.
20. Struers equipment must only be used in connection with and as described in the Instruction Manual supplied with the equipment.
21. If the equipment is subjected to misuse, incorrect installation, alteration, neglect, accident or incorrect repair, Struers will accept no responsibility for damage to the user or the equipment.
22. Dismantling of any part of the equipment, during service or repair, should always be performed by a qualified technician (electromechanical, electronic, mechanical, pneumatic, etc.).

2.3 Safety messages

Struers uses the following signs to indicate potential hazards.



ELECTRICAL HAZARD

This sign indicates an electrical hazard which, if not avoided, will result in death or serious injury.



DANGER

This sign indicates a hazard with a high level of risk which, if not avoided, will result in death or serious injury.



WARNING

This sign indicates a hazard with a medium level of risk which, if not avoided, could result in death or serious injury.



CRUSHING HAZARD

This sign indicates a crushing hazard which, if not avoided, could result in minor, moderate or serious injury.

**HEAT HAZARD**

This sign indicates a heat hazard which, if not avoided, can result in minor, moderate or serious injury.

**CAUTION**

This sign indicates a hazard with a low level of risk which, if not avoided, could result in minor or moderate injury.

**Emergency stop**

Emergency stop

General messages**Note**

This sign indicates that there is a risk of damage to property, or a need to proceed with special care.

**Hint**

This sign indicates that additional information and hints are available.

2.4 Safety messages in this manual**ELECTRICAL HAZARD**

Switch off the electrical power supply before installing electrical equipment. The machine must be earthed (grounded). Make sure that the actual electrical power supply voltage corresponds to the voltage stated on the name plate of the machine. Incorrect voltage can damage the electrical circuit.

**ELECTRICAL HAZARD**

The pump of the recirculation cooling unit must be earthed (grounded). Make sure that the electrical power supply voltage corresponds to the voltage stated on the name plate of the pump. Incorrect voltage can damage the electrical circuit.

**CRUSHING HAZARD**

Take care of your fingers when handling the machine. Wear safety shoes when handling heavy machinery.

**WARNING**

Do not use the emergency stop for operational stop of the machine during normal operation. Before you release the emergency stop, investigate the reason for activating the emergency stop and take any necessary corrective action.



WARNING

Struers equipment must only be used in connection with and as described in the Instruction Manual supplied with the equipment.



WARNING

The operator must read the safety precautions and Instruction Manual, as well as relevant sections of the manuals for any connected equipment and accessories.



WARNING

When the disc is rotating, make sure your hands are kept completely clear of its periphery and out of the splash bowl.



WARNING

Keep your hands clear of the flexible specimen holder when lowering the specimen mover.



WARNING

When you perform manual grinding or polishing, be careful not to touch the disc.



WARNING

Do not try to collect a specimen from the tray while the disc is rotating.



WARNING

Switch off the machine, disconnect the electrical power cable and wait 5 minutes before you dismantle the machine or install additional components.



WARNING

Do not use the machine with defective safety devices.
Contact Struers Service.



WARNING

Safety critical components must be replaced after a maximum lifetime of 20 years.
Contact Struers Service.



WARNING

An exhaust system is required when working with alcohol-based suspensions or lubricants.



WARNING

In case of fire, alert bystanders, the fire brigade and cut power. Use a powder fire extinguisher. Do not use water.

**CAUTION**

If you are working with alcohol-based consumables, you must replace the tubes with the silicone tubing supplied with the DP dosing module.

**CAUTION**

Prolonged exposure to loud noises may cause permanent damage to a person's hearing.
Use hearing protection if the exposure to noise exceeds the levels set by local regulations.

**CAUTION**

Risk of hand to arm vibration during manual preparation.
Prolonged exposure to vibration may cause discomfort, joint damage or even neurological damage.

**CAUTION**

Keep clear of rotating parts during operation.
When working at machines with rotating parts, take care to prevent clothes and/or hair from being caught by the rotating parts.

**CAUTION**

Make sure that the MD-Disc is completely dry before you install an MD-surface.
Use a cloth to dry the MD-Disc.

**CAUTION**

Always use goggles, gloves and other recommended protective clothing.

**CAUTION**

Wear suitable gloves to protect fingers from abrasives and warm/sharp specimens.

3 Get started

3.1 Device description

Tegramin-20 is a semi-automatic or manual machine for metallographic preparation (grinding/polishing) for 200 mm diameter preparation disc.

The operator selects the preparation method, the grinding/polishing surface and the cooling fluid/abrasive suspension to be automatically applied.

Semi-automatic preparation starts by clamping the specimens in the specimen mover plate.

Manual preparation may be selected for special applications. The specimens are hand-held during the preparation.

For the semi-automatic process, pressurized feet from the mover head keep the specimens in place.

The operator starts the machine manually by pressing the Start button.

The machine stops automatically, and the operator cleans the specimens before the next preparation step or inspection.

The machine must always be used with the splash guard in place.

We recommend connecting the machine to an exhaust system to remove fumes from the working area.

For models with cover, the machine stops if the cover is opened, unless **Allow operation with cover open** is selected.

If the emergency stop is activated, the power to all moving parts is cut.

Tegramin-20 models:

- With cover
- Without cover
- With three dosing pumps
- With cover and three dosing pumps

3.2 Overview

Front view

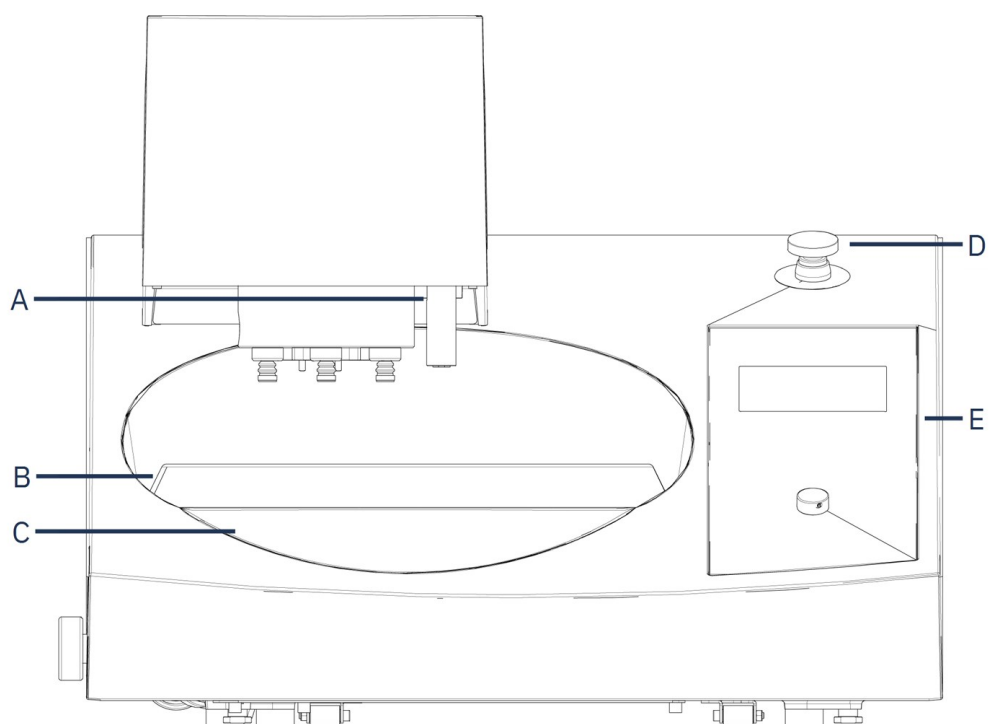

A Dosing nozzle

B Splash guard

C Bowl and bowl liner

D Emergency stop

E Control panel

Footprint

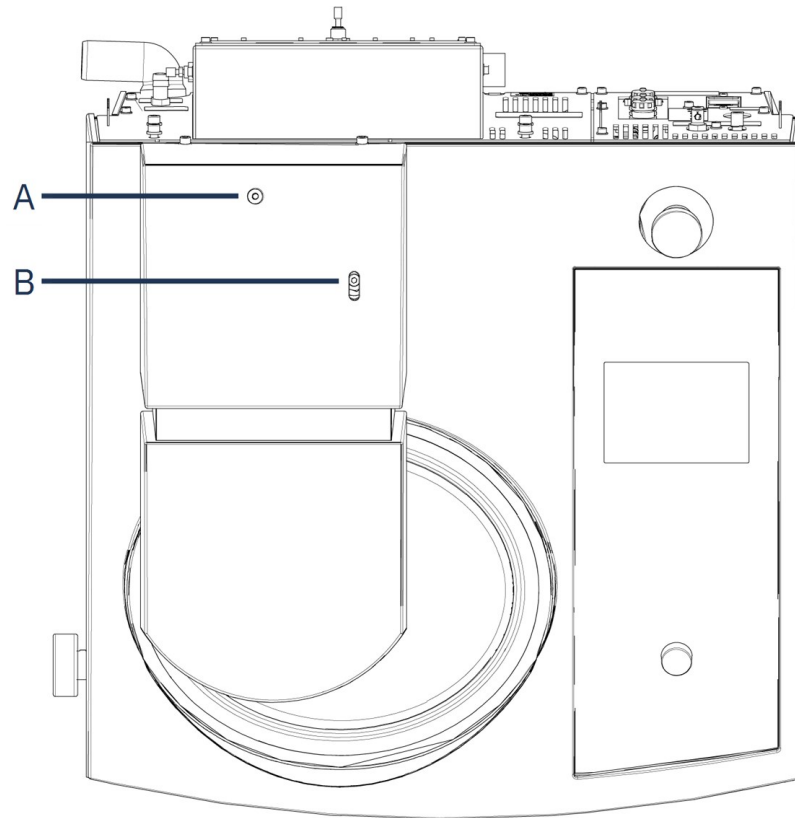

-
- A** Adjustment screw for the specimen mover plate height
 - B** Horizontal adjustment screw
-

Rear view

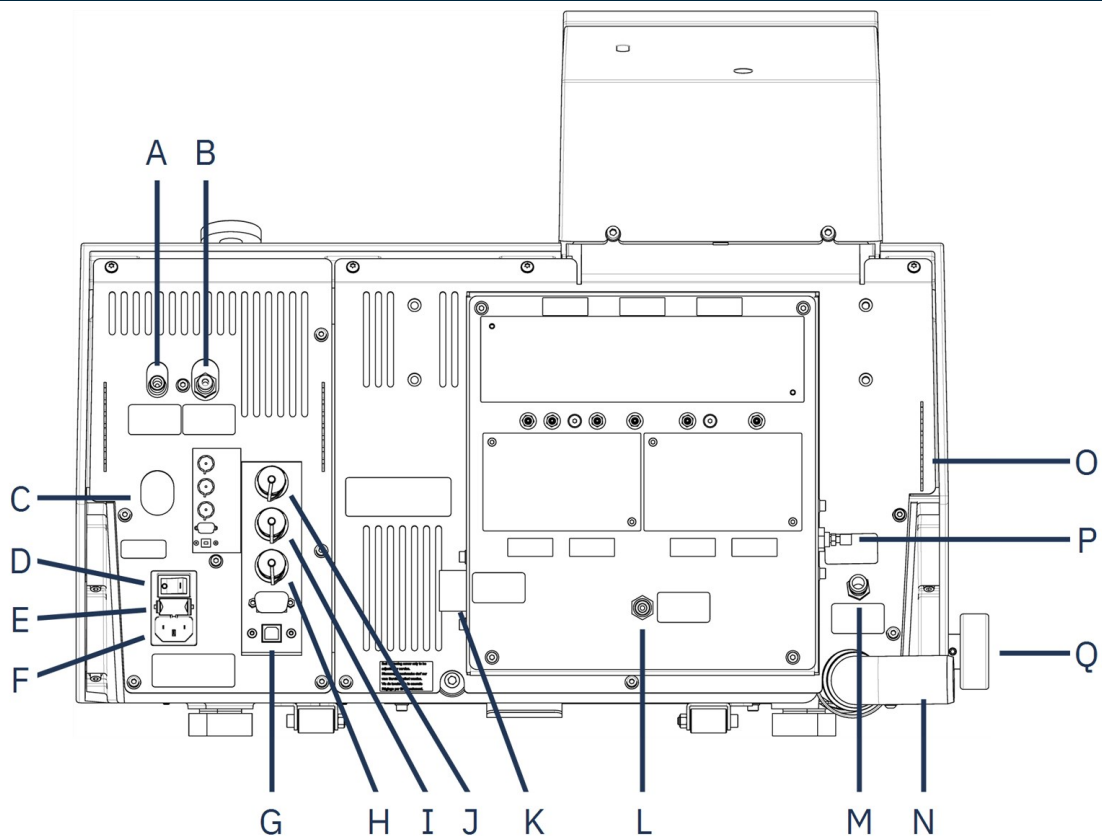

- | | |
|--|--|
| A Air outlet for shift valve | J Socket for cover connection |
| B Compressed air inlet | K Water inlet (water supply 3/4") |
| C Release outlet valve from water/oil filter for compressed air | L Water inlet (from Recirculation Cooling Unit) |
| D Main switch | M OP-S module, flushing water |
| E Fuse drawer | N Water outlet pipe |
| F Power supply connection | O Holders for dosing tubes |
| G USB port, for service purposes | P Throttle valve, flushing water for OP |
| H Recirculation cooling unit connection | Q Water valve, for wet grinding |
| I Connection for shift valve | |

Cover

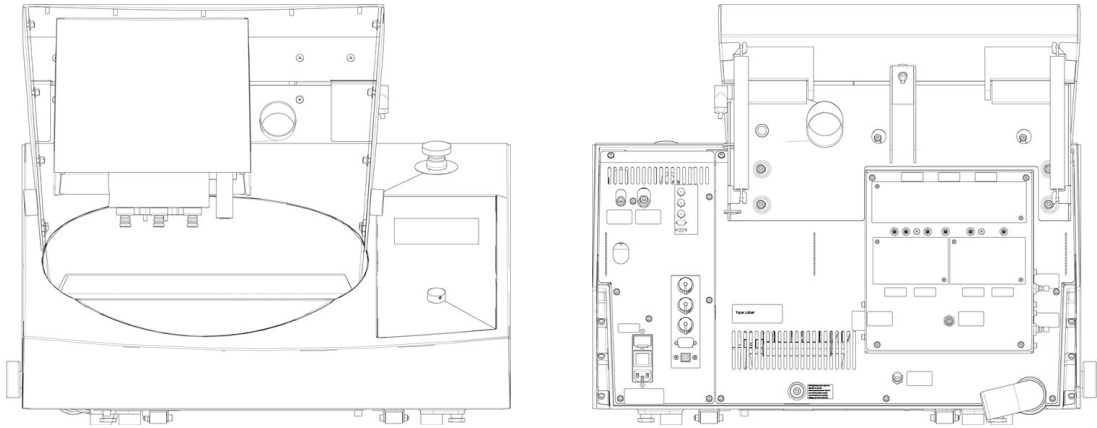

A standard cover is available as an optional accessory.

Socket for cover connection

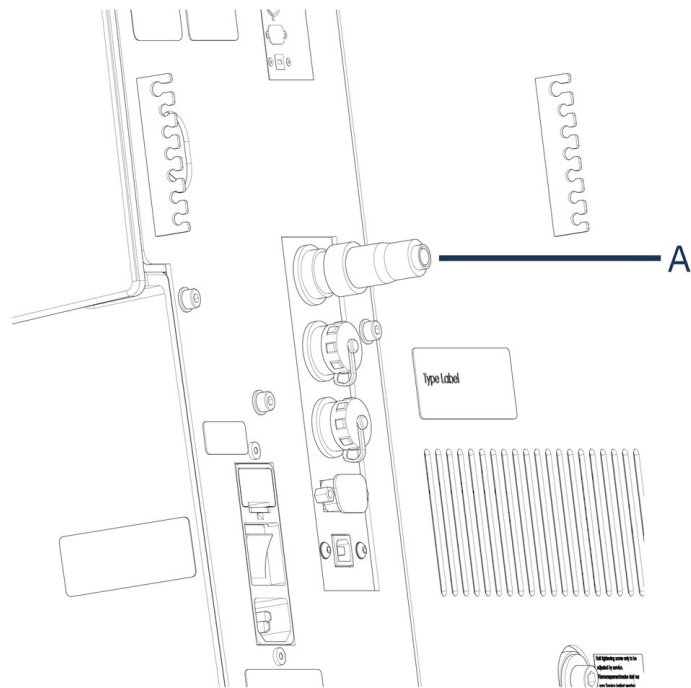

A Dummy plug

A dummy plug must be in place for the machine to operate without a cover installed.

3.3 Emergency stop

WARNING

Do not use the emergency stop for operational stop of the machine during normal operation.

Before you release the emergency stop, investigate the reason for activating the emergency stop and take any necessary corrective action.

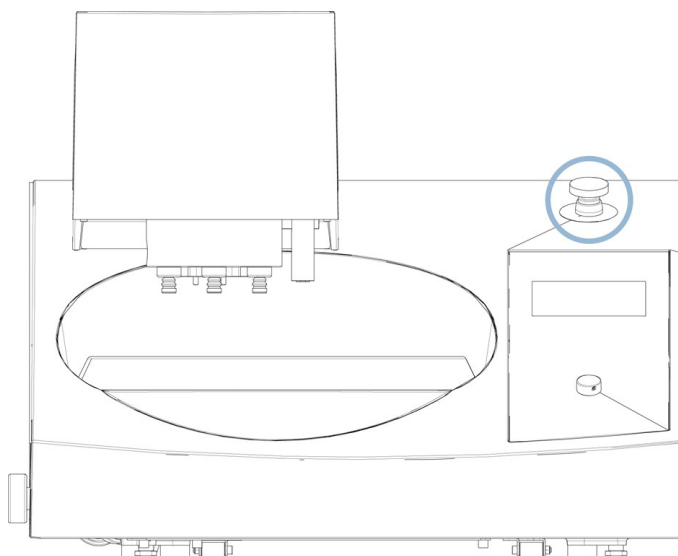

- To activate the emergency stop, press the red emergency stop button.
- To release the emergency stop, turn the red emergency stop button clockwise.

4 Installation

4.1 Unpack the machine

Note

We recommend that you keep all original packaging and fittings for future use.

You need a crane and 2 lifting straps to lift the machine off the pallet.

Note

The straps must be approved for at least twice the weight of the machine.

1. Unscrew the screws on the base of the packing crate.
2. Lift the top part of the crate.
3. Use a 4 mm Allen key to remove the metal brackets securing the machine to the pallets.

4.2 Check the packing list

Optional accessories may be included in the packing box.

The packing box contains the following items:

| Pcs. | Description |
|------|--|
| | Tegramin |
| | Models: |
| 1 | <ul style="list-style-type: none"> - Without cover: Dummy plug mounted. - With cover: Cover mounted. - With pumps: Dosing modules are installed |
| 2 | Electrical power supply cables |
| 1 | Splash guard |
| 1 | Water inlet hose. Diameter: 19 mm (¾"). Length: 2 m (6.6') |
| 1 | Filter gasket |
| 1 | Reduction ring with gasket, ¾" to ½" |
| 1 | Water outlet hose. Diameter: 40 mm (1.6"). Length: 1.5 m (4.9') |
| 2 | Hose clamps |
| 1 | Connection piece for compressed air to 6 mm (1/8") Diameter tube |
| 1 | Allen key with cross handle, 6 x 150 mm (0.2 x 6") |
| 1 | Instruction Manual set |

4.3 Lift the machine



CRUSHING HAZARD

Take care of your fingers when handling the machine.
Wear safety shoes when handling heavy machinery.

| Weight | |
|----------------------------------|-------------------|
| Tegramin-20 without cover | 52.5 kg (116 lbs) |
| Tegramin-20 with cover | 58 kg (128 lbs) |

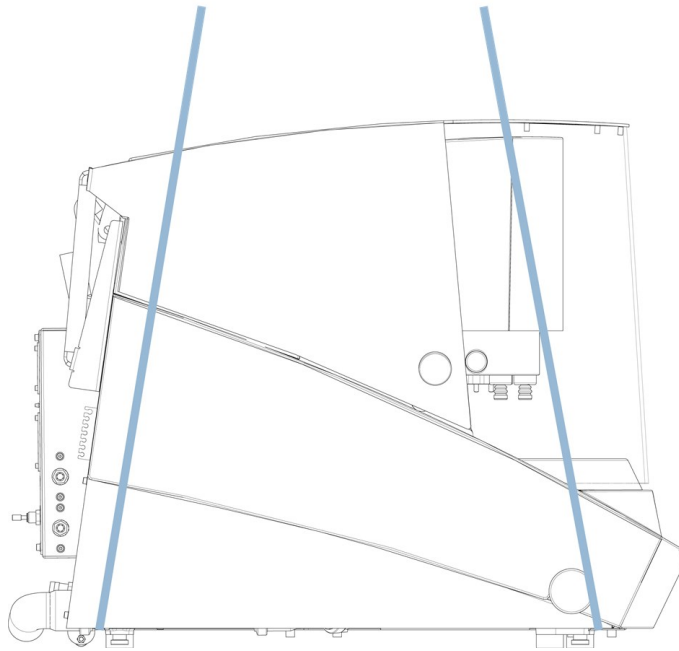

1. Place the 2 lifting straps under the machine on the outer part of the feet.
Make sure that the straps are long enough to avoid putting pressure on the cover (approximately 3- 3.5 m / 10 - 11.5 ft).

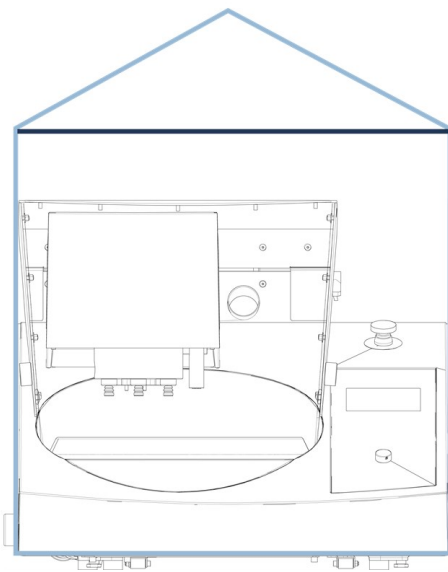

Lifting straps on the machine with safety cover

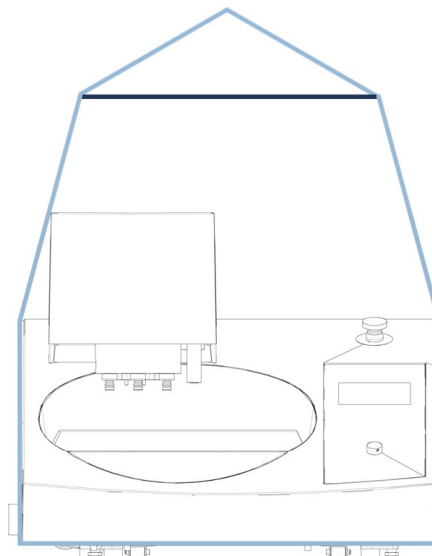

Lifting straps on the machine without cover

2. Use a lifting bar to keep the 2 straps apart below the lifting point.
3. Place the machine on the workbench.
4. Lift the front of the machine and carefully move it into place using the rollers.

4.4 Location



CRUSHING HAZARD

Take care of your fingers when handling the machine.
Wear safety shoes when handling heavy machinery.

1. Remove the screw holding the transport lock on the cone shaft.
 2. Press the black release button and remove the transport lock.
- The machine must be placed on a safe and stable table with an adequate working height. The table must be able to carry at least the weight of the machine and the accessories.

Recommended workbench dimensions

X: 92 cm (36.2")

Y: 90 cm (35.4")

Z: 80 cm (31.5")

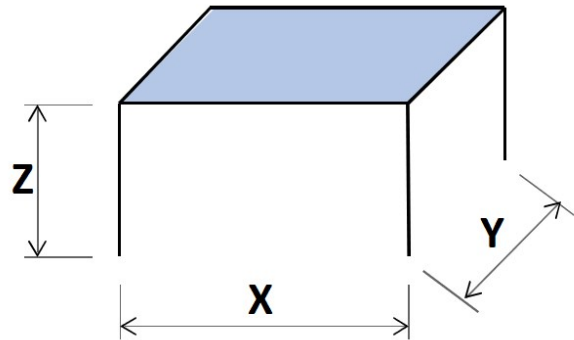

- The machine must be placed close to the electrical power supply, main water supply and waste water drain.
- To facilitate easy access for service technicians, allow sufficient space around the machine.
- To move the machine, lift the front of the machine and use the rollers to carefully move it into place.
- The machine must rest securely with all 4 feet on the table.
- Make sure that there is enough room behind the machine to fully open the cover.
- Make sure that there is enough room behind the machine for the inlet and outlet hoses.
- The machine must be placed in a well-ventilated room or connected to an exhaust system.
- Make sure that there is enough room behind the machine for the exhaust hose.
- Make sure that there is enough room for the bottle tray on either side of the machine.

Illumination

- Make sure that the work station has adequate lighting. Avoid direct glare (dazzling light sources within the operator's line of vision) and reflected glare (reflections of light sources). A minimum of 300 Lumen is recommended to illuminate the controls and other work areas.

Ambient conditions

| | | |
|-----------------------|-------------------------|---|
| Operating environment | Surrounding temperature | Operation: 5-40°C (40-105°F) Storage: 0-60°C (32-140°F) |
| | Humidity | Operation: 35-85% RH non-condensing Storage: 0-90% RH non-condensing |

4.5 Power supply**WARNING**

Switch off the machine, disconnect the electrical power cable and wait 5 minutes before you dismantle the machine or install additional components.

**ELECTRICAL HAZARD**

Switch off the electrical power supply before installing electrical equipment. The machine must be earthed (grounded). Make sure that the actual electrical power supply voltage corresponds to the voltage stated on the name plate of the machine. Incorrect voltage can damage the electrical circuit.

**Note**

An autotransformer is required in countries with a 110 V electrical power supply.

Electrical data

| | | |
|--------------|-----------------------|---|
| Power supply | Voltage/frequency | 200-240 V (50-60 Hz) |
| | | 1-phase (N+L1+PE) or 2-phase (L1+L2+PE) |
| | Power, inlet | The electrical installation must comply with Installation Category II |
| | Power, nominal load | 680 W |
| | Power, idle load | 9 W |
| | Current, nominal load | 3.4 A |
| | Current, maximum load | 6.3 A |
| | Current, largest load | 1.85 A |

Power socket

The electrical power supply socket must be easy to access. The electrical power supply socket must be located at a height ranging from 0.6 m to 1.9 m/2½” to 6’ above floor level. Not higher than 1.7 m/5’ 6” is recommended.

Note
 The equipment is shipped with 2 types of electrical power cables. If the plug supplied on these cables is not approved in your country, the plug must be replaced with an approved plug.

4.5.1 Single-phase supply

Single-phase supply

The 2-pin plug (European Schuko) is for use on single-phase electrical power connections.



The leads must be connected as follows:

| | |
|--------------|----------------|
| Yellow/Green | Earth (ground) |
| Brown | Line (live) |
| Blue | Neutral |

4.5.2 2-phase supply

The 3-pin plug (North American NEMA) is for use on 2-phase electrical power connections.



The leads must be connected as follows:

| | |
|-------|----------------|
| Green | Earth (ground) |
| Black | Line (live) |
| White | Line (live) |

4.5.3 Connection to the machine

- Connect the electrical power cable to the machine (C14 IEC 320 connector).
- Connect the cable to the electrical power supply.

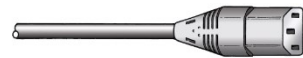

4.6 Water supply and water outlet

Water for wet grinding is supplied from the main water supply or from a recirculation cooling unit (optional).

4.6.1 Connect the machine to the water supply

Note
 The cold-water supply must have a head pressure in the range: 1 -10 bar (14.5 -

**Hint**

New water pipe installations:
Let the water run for a few minutes to flush any debris from the pipe before you connect the machine to the water supply.

Connecting the water inlet hose

Connect the 90°-angle end of the water inlet hose to the water inlet on the back of the machine:

1. Insert the filter gasket in the coupling nut with the flat side against the water inlet hose.
2. Tighten the coupling nut firmly.

Connect the straight end of the water inlet hose to the water supply tap for cold water:

1. If needed, connect the reduction piece with gasket to the water supply tap.
2. Tighten the coupling nut firmly.

4.6.2 Connect the machine to the waste water outlet

1. Connect the elbow pipe to the waste water outlet pipe.
2. Connect the waste water outlet hose to the elbow pipe. If needed, lubricate with grease or soap to make it easier to insert the pipe in the hose. Use a hose clamp to fasten the hose to the pipe.
3. Lead the other end of the waste water hose to the waste water drain. If needed, shorten the hose.

**Note**

Make sure that the hose slopes downward towards the waste water drain throughout its entire length.
Make sure that there are no sharp bends in the waste water hose.

4.6.3 Install the shift valve - Optional

1. Mount the water outlet hose to the water outlet pipe on the machine.
2. Mount the opposite end of the water outlet hose on the pipe labeled **From Tegramin** on the shift valve.
3. Mount a 1.5 m (5 ft) piece of hose on the pipe labeled **Cooli**, and lead the opposite end to the recirculation cooling unit.
4. Fasten the hose using a hose clamp.
5. Mount the second 1.5 m (5 ft) piece of hose on the pipe marked **Drain**, and place the opposite end of the hose in the drain.
6. Fasten the hose using a hose clamp.
7. Connect the compressed air hose to the compressed air inlet on the machine, and fit the other end to the shift valve labeled **Connect to Tegramin**.
8. Connect the plug to the socket on the rear of the machine labeled **Shift valve**.



Note

Make sure that the hose slopes downward towards the waste water drain throughout its entire length.
Make sure that there are no sharp bends in the waste water hose. If needed, shorten the hose.

4.6.4 Adjust the water flow

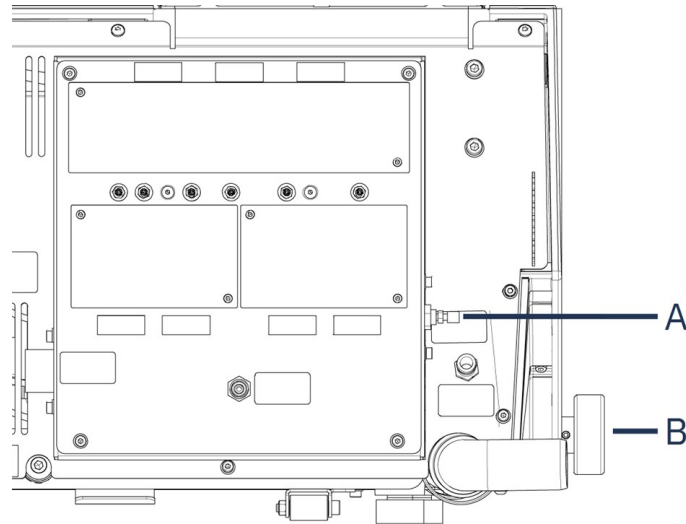

A Throttle valve, flushing water from OP

B Water valve

- Use the water valve to adjust the flow of cooling water when grinding.
- Use the throttle valves to adjust the water flow for disc cooling and flushing after OP.

4.7 Recirculation unit

To ensure optimal cooling, mount a recirculation cooling unit on the machine.



ELECTRICAL HAZARD

The pump of the recirculation cooling unit must be earthed (grounded).
Make sure that the electrical power supply voltage corresponds to the voltage stated on the name plate of the pump.
Incorrect voltage can damage the electrical circuit.



Note

Before you connect the recirculation unit to the machine, you must prepare it for use. See the Instruction Manual for this unit.

**Note**

When you connect the machine to both the water supply and the recirculation cooling unit, you must also install the shift valve for the drain. Failure to do this may result in emptying or overflowing the recirculation cooling unit.

4.7.1 Connect the recirculation unit to the water inlet

To connect the recirculation cooling unit follow these steps:

1. Mount the yellow cap (supplied) on the water inlet for the main water supply.
2. Remove the quick coupling from one end of the hose delivered with the pump.
3. Slide the hose clamp onto the hose and connect to the water inlet for recirculation water on the back of the machine. Tighten the hose clamp.

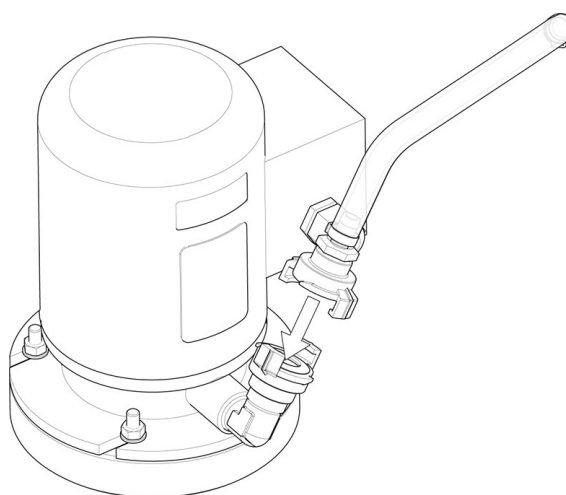

4. Connect the quick coupling at the other end of the inlet hose directly to the pump outlet of the cooling unit.

4.7.2 Connect the recirculation unit to the water outlet

A Static filter unit

1. Connect the water outlet hose to the water outlet pipe. Use a hose clamp to secure the hose.
2. Lead the other end of the hose into the mounting hole in the bracket on top of the static filter unit.
3. Make sure that the hose slopes downward towards the waste water drain throughout its entire length. If needed, shorten the hose.

4.7.3 Connect the communication cable

- Connect the communication cable from the control box of the recirculation cooling unit to the socket on the back of the machine.

4.8 Compressed air

**Note**

The machine requires a continuous flow of compressed air through the regulator valve. A faint hissing sound does not mean that there is an air leak in the system.

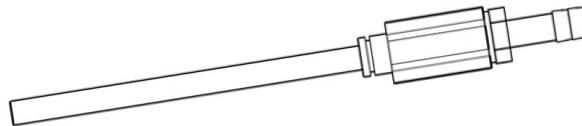

1. Mount the connection piece on the compressed air hose.
2. Secure the connection piece with the supplied hose clamp.
3. Connect the air inlet hose to the quick coupling.
4. Connect the opposite end of the hose to the compressed air inlet on the machine.

**Note**

The air pressure must be 6 - 10 bar (87 - 145 psi).
The air flow must be 3.5 - 4.0 L/min (0.9-1.1 gal/min).
Recommended air quality: The air supplied must be of Class 5.6.4. or better, as specified in ISO 8573-1.

4.9 External exhaust system

For Tegramin with cover only.

**WARNING**

An exhaust system is required when working with alcohol-based suspensions or lubricants.

Connect a 50 mm (2") diameter pipe to the outlet at the rear of the machine, on the cover bracket, and connect it to the exhaust system.

Minimum capacity: 50 m³/h (1766 ft³/h) at 0 mm (0") water gauge.

4.10 Mount the dosing modules

**CAUTION**

If you are working with alcohol-based consumables, you must replace the tubes with the silicone tubing supplied with the DP dosing module. See [Change the tubes ▶67](#).

1. Remove the cover plates.
2. Slide the dosing modules into the correct place on the rear of the machine as shown in the picture below.
3. Secure the modules with the supplied screws.
4. Connect the short piece of tube with the 90° angle and the clear tube to the connectors on the rear of the machine.
5. Lead the long tubes from the pumps to the lubricant / suspension bottles, and connect them to connector on top of the bottle.

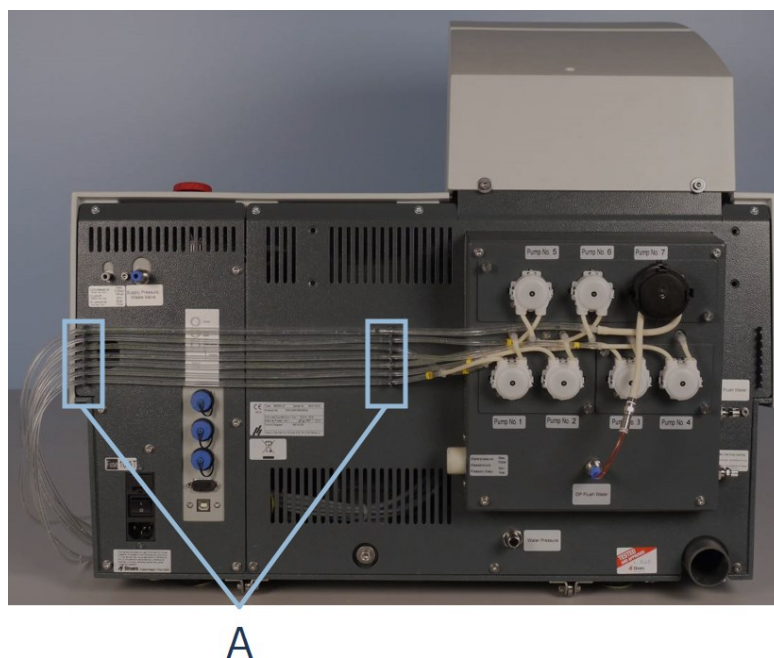

A Tube holders

6. Place the tubes in the tube holder.

OP dosing

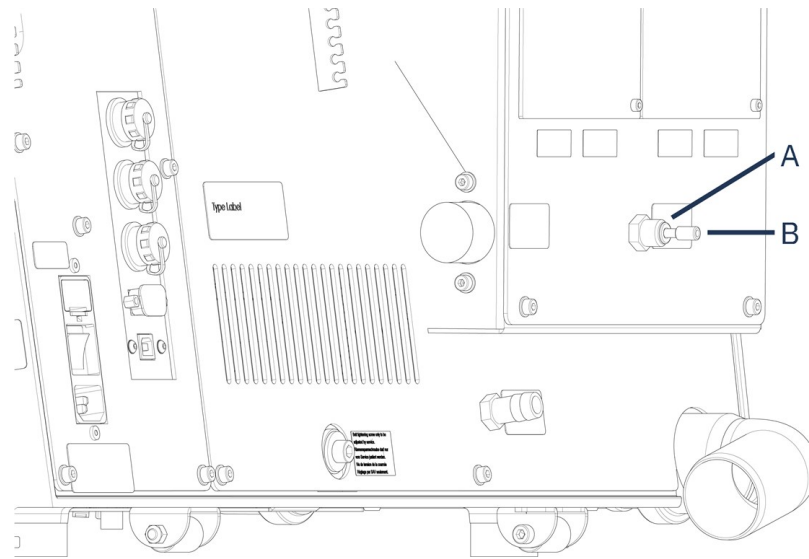

A OP flush water connector

B Cap

To mount the module with an OP pump:

1. Push the connector disc inwards and remove the blue cap from the OP flush water connector.
2. Lead the tube from the OP pump (Pump No. 7).
3. Press the connector disc inwards.
4. Insert the tube into the connector.



Hint
The tubes from the 2 DP dosing modules are numbered 1/3 or 2/4. Depending on the position the dosing modules are placed in please, remove the numbers that do not match, on both ends of the tube.

4.11 Mount the preparation disc



CAUTION
Make sure that the MD-Disc is completely dry before you mount an MD-surface. Use a cloth to dry the MD-Disc.



Note
Make sure that the cavity on the underside of the preparation disc and the cone on the machine are clean.
Make sure that the bowl liner is clean and that the drain is positioned correctly.

Procedure

- Place the preparation disc carefully on the driving pin. Rotate it slowly until it is safely engaged.

4.12 Noise

For information on the sound pressure level value, see this section: [Technical data ▶82](#).



CAUTION

Prolonged exposure to loud noises may cause permanent damage to a person's hearing.

Use hearing protection if the exposure to noise exceeds the levels set by local regulations.

How to handle noise during operation

Different materials have different noise characteristics.

Manual preparation

To lower the noise, try to decrease the force with which the specimen is pressed against the preparation surface. The processing time may increase.

Semi-automatic preparation

To lower the noise, decrease the rotational speed and/or the force with which the specimens are pressed against the preparation surface. The processing time may increase.

5 Transport and storage

If, at any time after the installation, you have to move the unit or place it in storage, there is a number of guidelines we recommend that you follow.

- Package the unit securely before transportation. Insufficient packaging could cause damage to the unit and will void the warranty. Contact Struers Service.
- We recommend that you use the original packaging and fittings.

5.1 Transport

1. Clean the machine and all accessories thoroughly.
2. Disconnect the suspensions or lubricants and make sure that the tubes are empty.
3. Remove the preparation disc.
4. Place the mover head transportation bracket and secure it with the screw.
5. Disconnect the unit from the electrical power supply.
6. Disconnect the water inlet and the water outlet.
7. Disconnect the compressed air supply.
8. Disconnect the cooling system, if installed. See the instructions for the specific unit.
9. Place a cloth in the bowl to collect remaining water (if there is any).
10. Remove the splash guard, the preparation disc and the bowl liner.
11. Use a crane and 2 lifting straps to lift the machine.

12. Position the straps under the machine, so that they are on the outer side of the feet.
13. Arrange the straps and the lifting bar as described in [Lift the machine ▶18](#).
14. Move the machine to its new location.

5.2 Long-term storage or shipping



Note

We recommend that you keep all original packaging and fittings for future use.

- For information on how to make the machine ready for transport, see also. [Transport ▶29](#).
- Place the machine and accessories in their original packaging.
- Secure the boxes on a pallet with straps.

At the new location

At the new location, make sure that the facilities required are in place.

6 Configuration

6.1 Prepare the device

6.1.1 Control panel functions



CAUTION



Keep clear of rotating parts during operation.





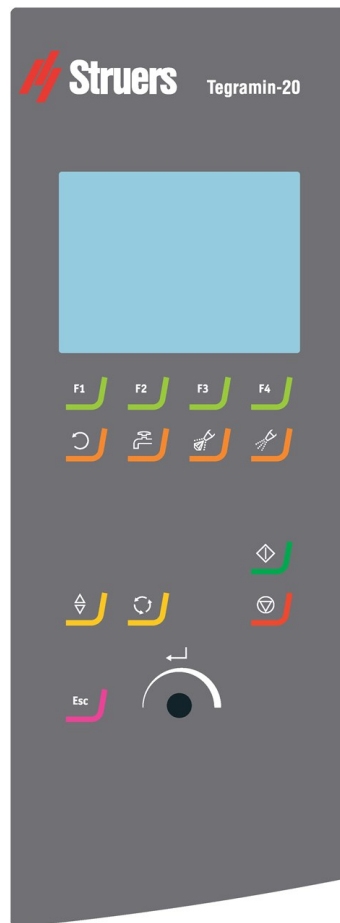





CAUTION

When working at machines with rotating parts, take care to prevent clothes and/or hair from being caught by the rotating parts.



| Button | Function |
|---|---|
|  | <p>Function keys</p> <p>Serve various purposes. See the bottom part of the screen for more information on how each function key works.</p> |
|  | <p>Disc rotation</p> <ul style="list-style-type: none"> Starts rotation of the disc (Spin function). |
|  | <p>Water</p> <p>Manual override</p> <ul style="list-style-type: none"> Press the button to apply water. Water is applied when no process is running. Press the button again to stop applying water. <p>The water flow will be switched off automatically after 5 minutes.</p> <p>If a recirculation unit is connected, recirculation water will be used.</p> |

| Button | Function |
|---|---|
|  | <p>Lubricant</p> <p>Manual override</p> <ul style="list-style-type: none"> • Press the button to apply lubricant. • Press the button again to stop applying lubricant. <p>This button is only active if a dosing module is installed.</p> |
|  | <p>Abrasive</p> <p>Manual override</p> <ul style="list-style-type: none"> • Press the button to apply diamond suspension. • Press the button again to stop applying diamond suspension. <p>This button is only active if a dosing module is installed.</p> |
|  | <p>Lower/Raise</p> <p>Lowers and raises the specimen mover head.</p> |
|  | <p>Rotate</p> <p>Rotates the specimen mover plate.</p> |
|  | <p>Escape</p> <ul style="list-style-type: none"> • Press this button to return to the previous screen or to cancel functions/changes. |
|  | <p>Start</p> <ul style="list-style-type: none"> • Starts the preparation process. |
|  | <p>Stop</p> <ul style="list-style-type: none"> • Stops the preparation process. |
|  | <p>Turn/push knob</p> <ul style="list-style-type: none"> • Push the knob to select a function. • Turn the knob to adjust settings. • Push the knob to store modified settings. |

6.1.2 Start the machine the first time

- Switch on the machine on the main switch on the back of the machine.

Select a language the first time

The first time you turn on the machine, you are asked to select the desired language. Use the turn/push knob to select your language and accept your changes.



Set the date and time

Use the turn/push knob to select and adjust the date and time.



Select **Save & Exit** to return to the **Main menu**.

6.1.3 The display

When you turn on the machine, the display shows the configuration and version of the software.

After start-up, the display returns to the screen last shown when the machine was turned off.

The display is divided into 2 main areas:

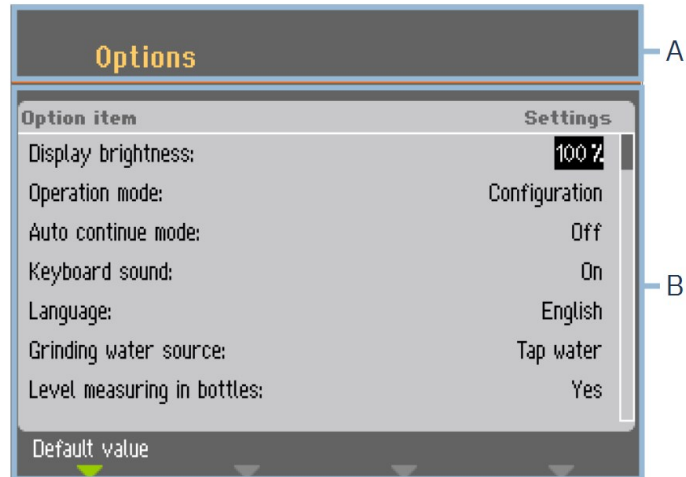

- A** Heading: This area shows you where you are in the software.
- B** Information fields: This area informs you about any parameters and values associated with the process indicated in the heading.

Navigating in the display

Use the buttons on the control panel to navigate in the display.

See [Control panel functions](#) ▶30.

6.1.4 Sound signals

| Sound | Description |
|-------------------|---|
| Short beep | A short beep, when you press a key, indicates that the selection is confirmed. You can enable or disable the beep: select Configuration . |
| Long beep | A long beep, when you press a button, indicates that the key cannot be activated at the moment. You cannot disable this beep. |

6.1.5 Edit values

Edit numeric values

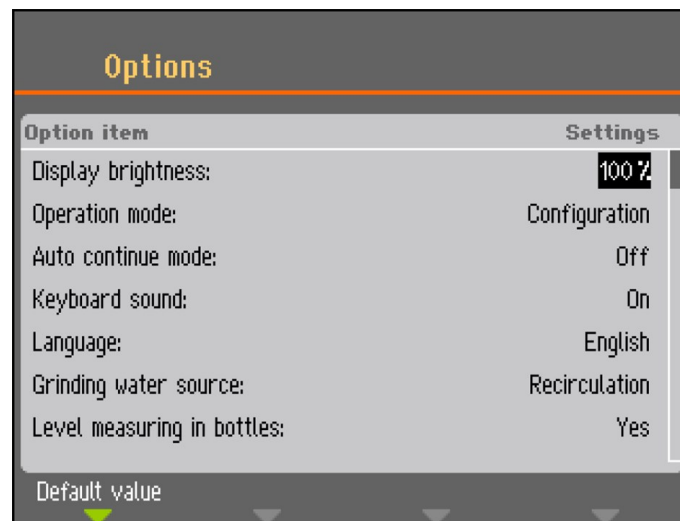

1. Turn the knob to select the value you want to change.

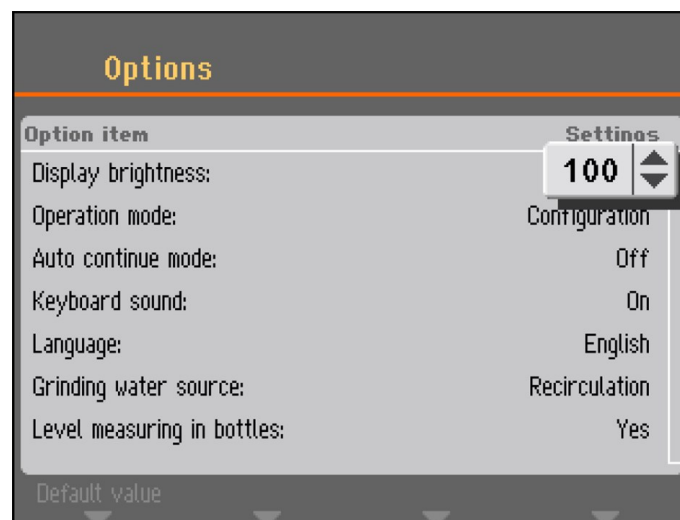

2. Push the knob to edit the value. A scroll box appears around the value.



Note

If there are only two options, the pop-up box is not displayed. Pushing the knob (Enter) will toggle between the 2 options.

3. Turn the knob to increase or decrease the numeric value (or to toggle between the two options).
4. Push the knob to accept the new value. If you press Esc, the changes are reversed to the original value.

Edit alphanumeric values

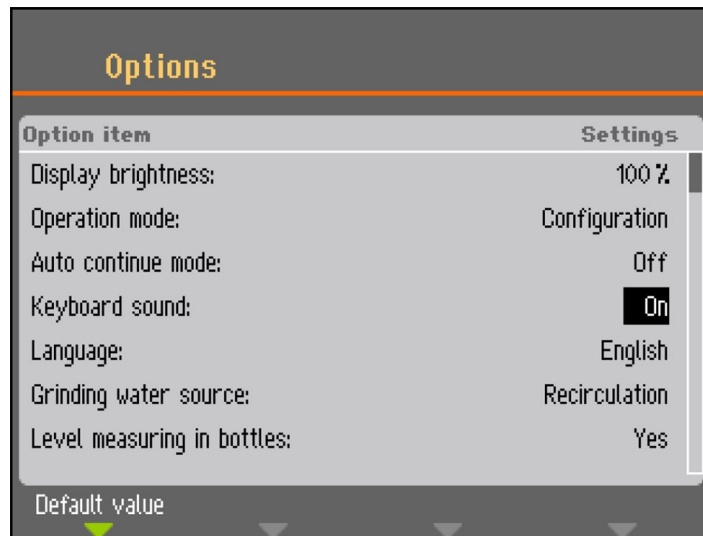

1. Turn the knob to select the text value you want to change.

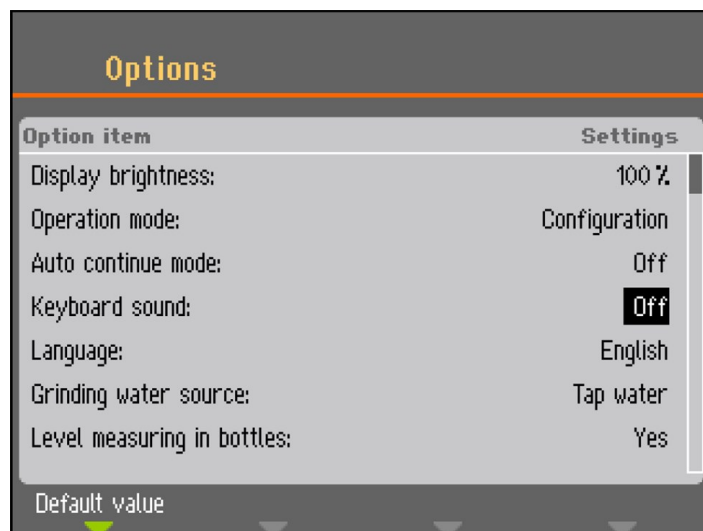

2. Push the knob to toggle between the 2 options.



Note

If there are more than two options, a pop-up box is displayed. Turn the knob to select the correct option.

3. Press Esc to accept the option and return to the previous menu, or turn the knob to select and edit other options in the menu.

6.2 Change the language

1. From the **Main menu**, select **Configuration**.
2. Select **Options**.
3. Select **Language**.



- Press the knob to open the language selection menu.

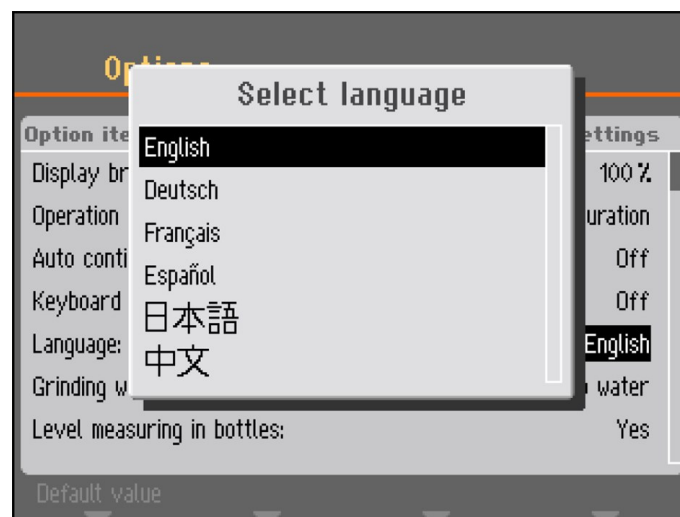

- Select the language you want to use.
- Press the knob to confirm your selection.
- Press Esc to return to the **Configuration** menu.

6.3 Change the settings

If needed, you can change several settings such as **Display brightness**, or, **Keyboard sound**.

Procedure

- From the **Main menu**, select **Configuration**.
- Select **Options**.
- Change any setting you need.
- Press the knob to confirm your selection.

- Press Esc to return to the **Configuration** menu.

6.4 Operation mode

In Operation mode, you can select among 3 different user levels:

- **Production:** You can select and view methods, but you cannot edit them.
- **Development:** You can select, view and edit methods.
- **Configuration:** You can select, view and edit methods. You can also configure bottles.

Change the operation mode

- From the **Main menu**, select **Configuration**.
- Select **Options**.
- Select **Operation mode**.
- Select **Pass code**.

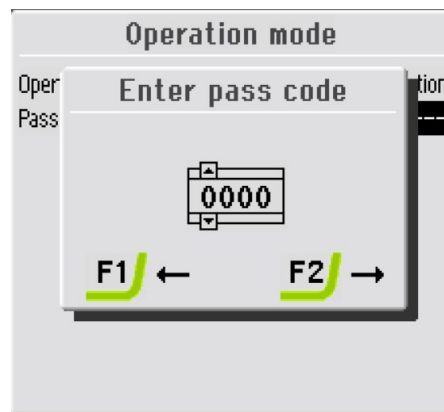

- Use the F1 and F2 keys to move from left to right, and the knob to change the digits.
- Enter the current pass code.
The default pass code is **2750**.
- Change the pass code to the desired digits.

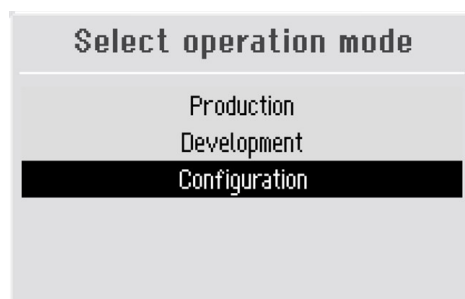

- Press the knob to select **Configuration**.
- Select the desired **Operation mode**.
- Press the knob to save your settings.

6.5 New pass code

To create a new pass code:

1. From the **Main menu**, select **Configuration**.
2. Select **Options**.
3. Select **Operation mode**.

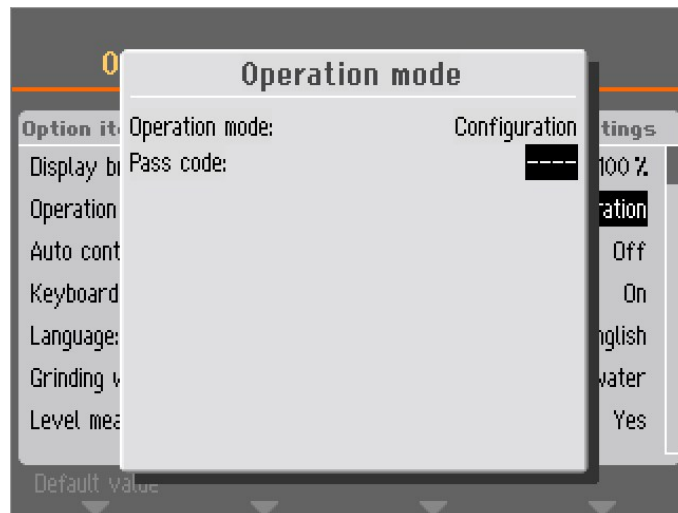

4. Select **Pass code**.



Note

You have 5 attempts to enter the right pass code after which the machine is locked.
Restart the machine and enter the correct pass code.



Hint

Make a note of the new pass code.

6.6 Bottle configuration

You must configure the bottles with lubricants and suspensions before you can start using the machine.

1. From the **Main menu**, select **Configuration**.
2. Select **Bottle configuration**.

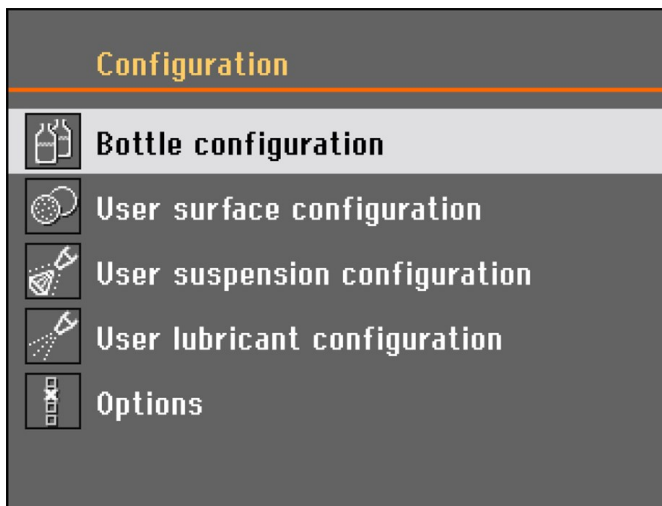

The number of configuration possibilities depends on the number of pumps installed on the machine (1 - 7).

3. Select the first bottle using the knob.
4. Press the knob to toggle among **Suspension**, **Lubricant**, or **None** (if there is no dosing bottle connected).

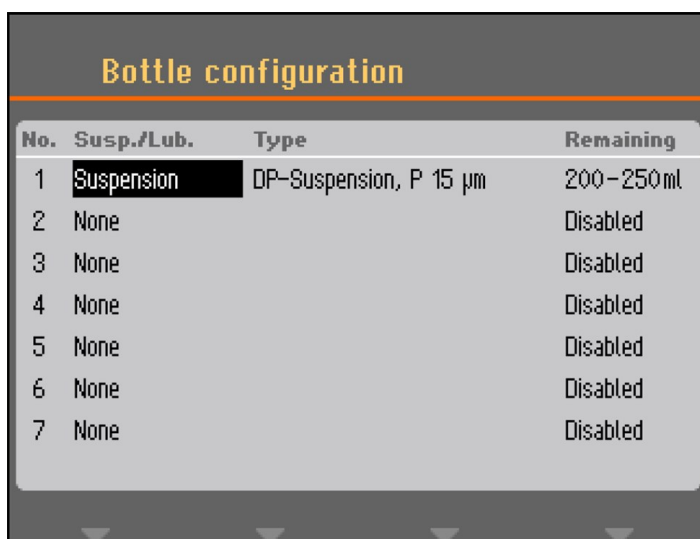

5. Select the relevant consumable, and turn the knob to select **Type** .

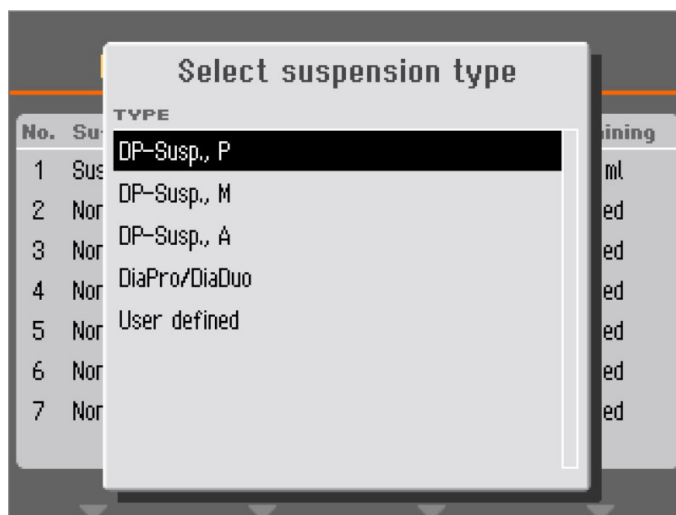

6. Select the type of consumable you are using.
7. Press the knob to save your selection.
8. Turn the knob to access the **Remaining** menu.

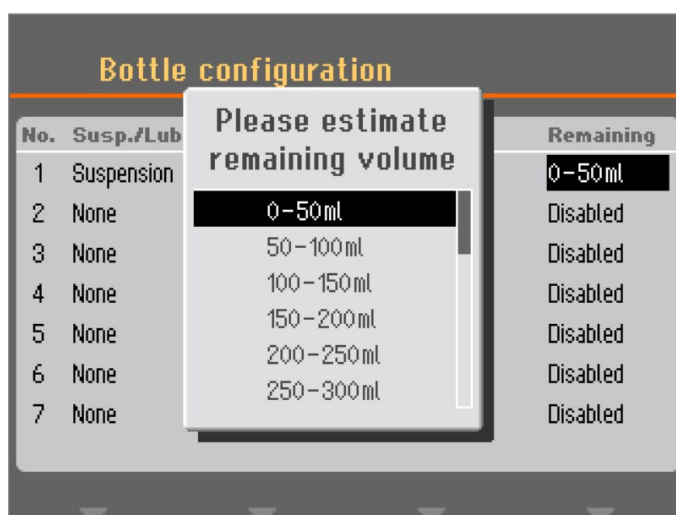

9. Select the value that reflects the remaining volume, and press the knob to save your setting.

This feature requires that the **Level measuring in bottles** function is set to **Yes** in the **Options** menu, under **Configuration**.

The amount of every suspension or lubricant used in the following preparations is automatically calculated, and deducted from the remaining volume in each of the bottles. A message is displayed when the calculated volume gets too low.

| Bottle configuration | | | |
|----------------------|------------|-----------------------|-----------|
| No. | Susp./Lub. | Type | Remaining |
| 1 | Suspension | DiaPro All/Lar. | 400-450ml |
| 2 | Suspension | DiaPro Largo | 350-400ml |
| 3 | Suspension | DiaPro Plus | 450-500ml |
| 4 | Suspension | DiaPro Nap-B | 250-300ml |
| 5 | Suspension | DP-Suspension, P & µm | 350-400ml |
| 6 | Lubricant | DP-Lubricant, Blue | 350-400ml |
| 7 | Suspension | DP-S | 850-900ml |

10. Repeat the procedure for the remaining pumps.

11. Press Esc until you return to the **Main menu**.

6.7 Set up the preparation process

6.7.1 Select a preparation mode

You can select among the preparation modes from the **Main menu**:

- **Single specimen methods**
- **Manual preparation** - (not available for Tegramin with safety cover).

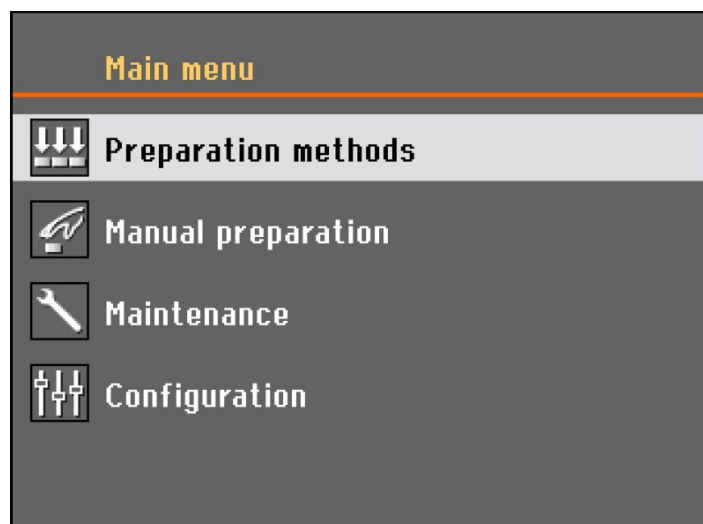

Select a preparation mode and press the knob.

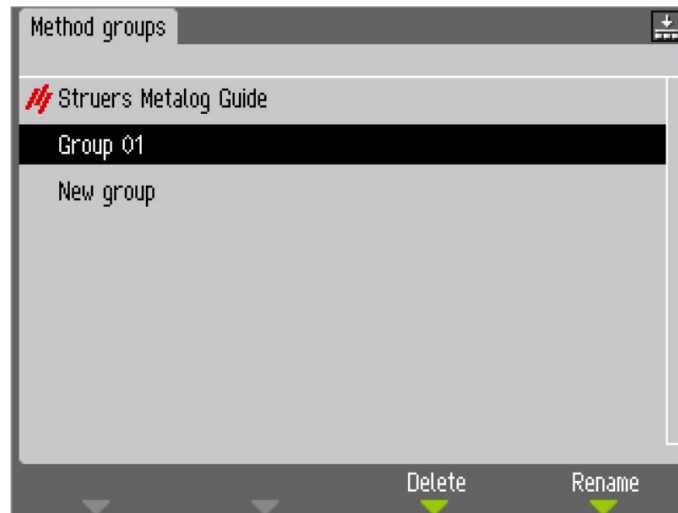

- Methods can be organized into user defined groups.
- Each group can contain up to 20 different preparation methods.
- Each method can have up to 10 steps.

The contents of the method groups are identical, whether you choose **Specimen holder methods** or **Single specimen methods**.

A method group or method created in one selection is automatically created in the other selection as well.

All method parameters are exactly the same when you initially create a method, except for the force. The relation between single specimen force and specimen holder force is 1 to 6, i.e. 30 N in single specimen mode will be 180 N in specimen holder mode and viceversa.

However, when you change a method parameter such as time or force later on, the other method will not be updated with the new values. This will allow for individual modifications due to specimen size and/or number.

If you change a preparation surface or suspension in a method, this will be reflected in the other method.

6.7.2 Select a preparation method

1. Open the the **Single specimen methods** menu.



Single specimen methods



Hint

A small icon in the top right corner indicates the selected method type.



2. Select a method group.

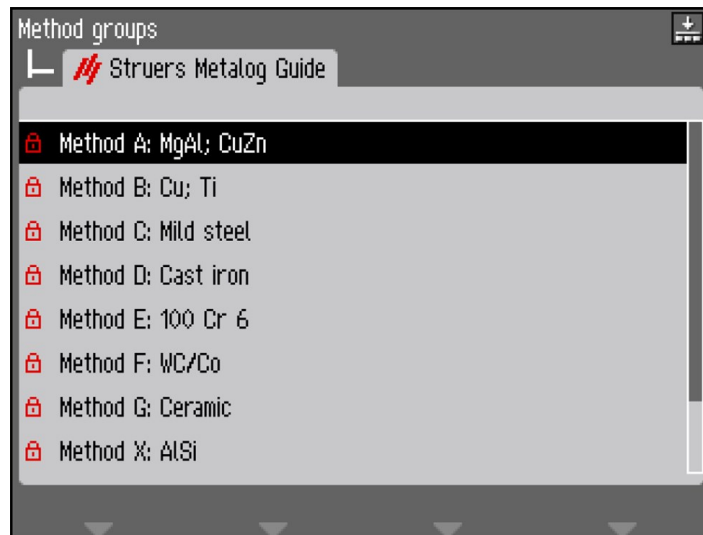

3. Select a method.

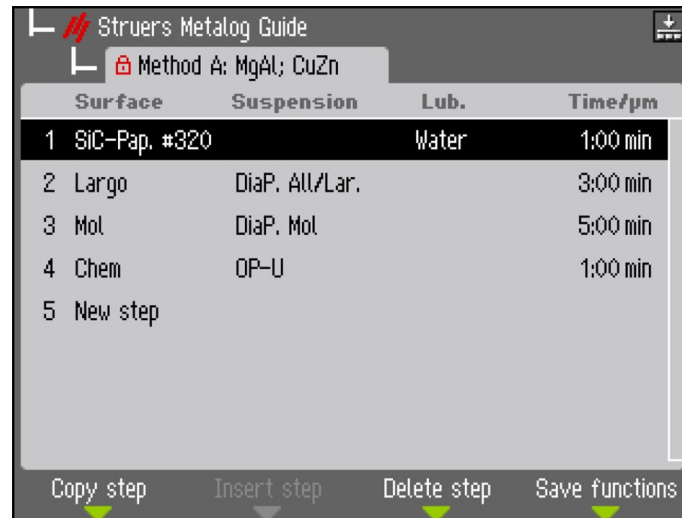

4. Select a preparation method.

6.7.3 Create a preparation method

Create method groups

1. In the **Method groups** menu, use the knob to select a method group.



2. Select **New method**.



3. Select **New step**.



The default settings for a typical preparation process are already selected:

- **Step No. 1** is designed to be a plane grinding step.
- **Step No. 2** is designed to be a fine grinding step.
- **Step No. 3** is designed to be a polishing step.

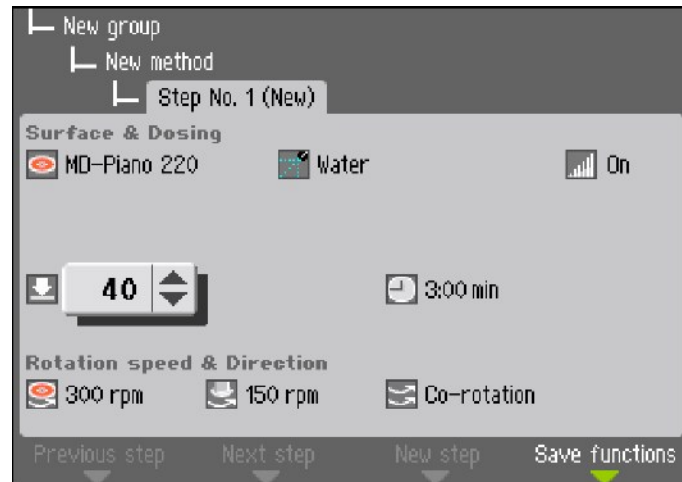

4. Select the parameter you want to edit.
5. Use the knob to edit the setting and push the knob to confirm the new setting, or press Esc to discard the changes.

**Hint**

An asterisk next to the method name indicates that a change has been made.

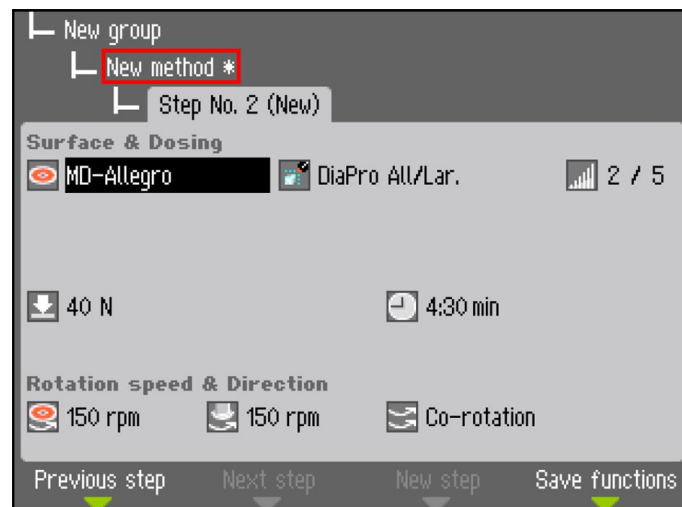

6. Press F3 **New step**.

**Note**

F3 **New step** is only available after at least one modification of the current preparation step.

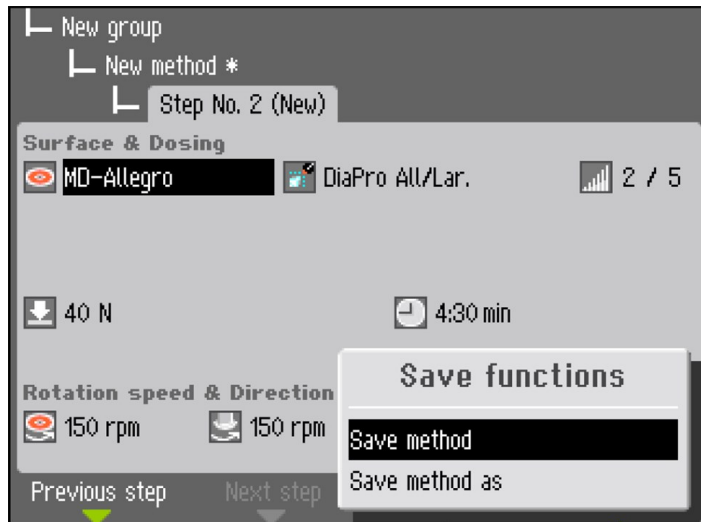

7. When all necessary preparation steps have been created and modified, press F4 **Save**.
8. Select **Save method** to save the method with the current name and method group. Alternatively, select **Save method as** and specify a new method group and a new method name.

Hint  You can create an entire preparation method step by step. However, an easier way would be to modify an existing preparation method. All existing preparation methods, including **Struers Metalog Guide** methods can be modified.

6.7.4 Modify a preparation method

1. Select the preparation method you want to modify.
2. Go through the different preparation steps and make the necessary adjustments.

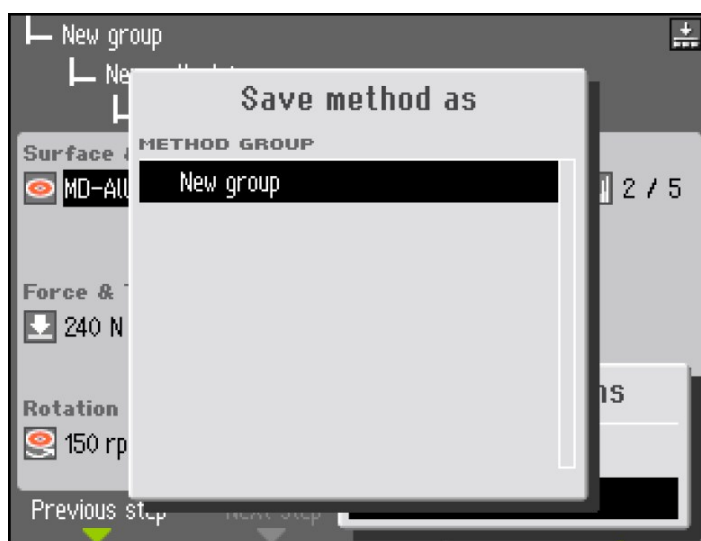

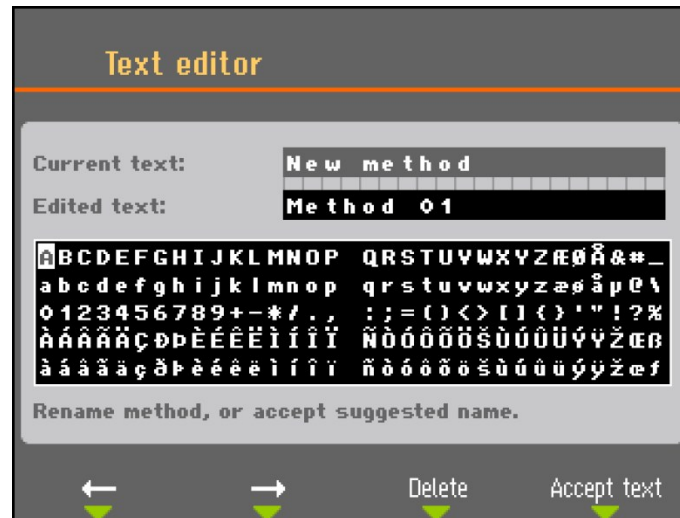

3. Press F4 **Save functions** and select **Save method as** to save the method under a different name and, if wanted, in a different group.

6.7.5 Set the dosing levels

When you use suspensions and/or lubricants in a preparation step, first you need to select the type of suspension or lubricant, and select the dosing level afterward.

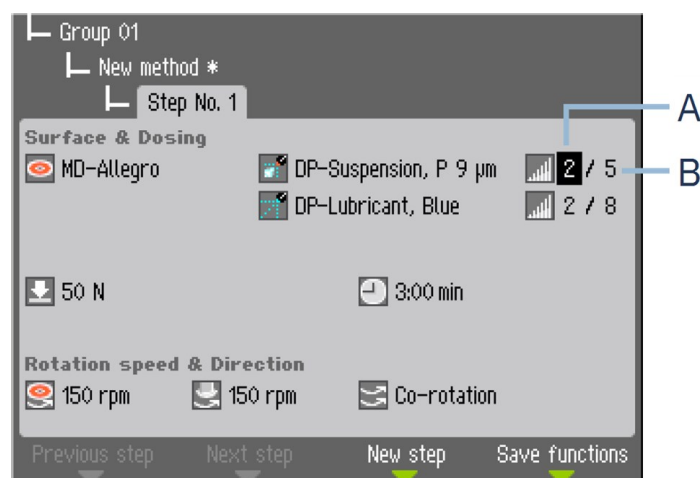

A Pre-dosing

B Dosing

Pre-dosing

The pre-dosing is the amount of suspension or lubricant applied onto the surface before the actual step is started. This parameter can be set to: 0 -10.

This is used to provide a lubricated surface to avoid any damage that could occur if the specimens were running on a dry surface.

Set the values based on the use frequency and the type of surface. Use a lower setting for frequently used surfaces, and a higher value for surfaces used only once in a while.

Dosing

The dosing level maintained throughout the preparation. This parameter can be set to: 0 - 20.

Set this parameter according to the type of surface. Soft, napped polishing cloths require more lubricant than hard, flat polishing cloths or fine grinding discs. Fine grinding discs require a lower dosing level of abrasive than polishing cloths.

6.7.6 Lock and unlock a preparation method

Lock methods to avoid accidental changes or deletion of a preparation method.

1. Open the **Method groups** menu.
2. Select the method you want to lock.
3. Press F1 **Change status**.

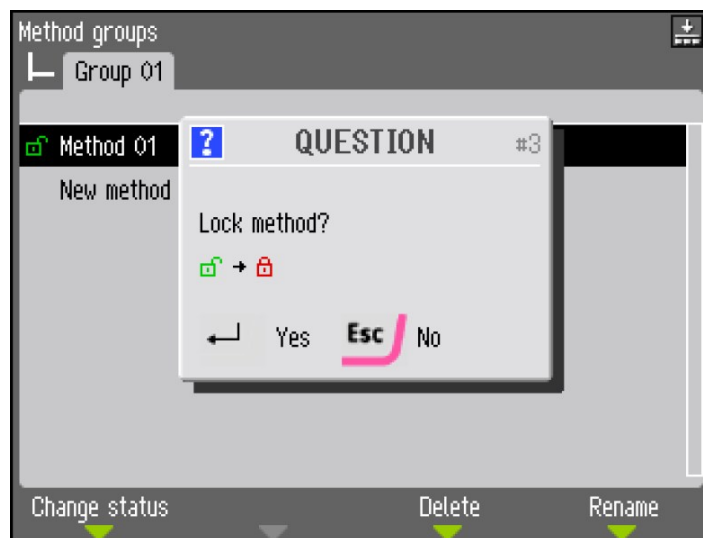

4. Push knob to lock the method. The green open padlock will change to a red closed padlock.

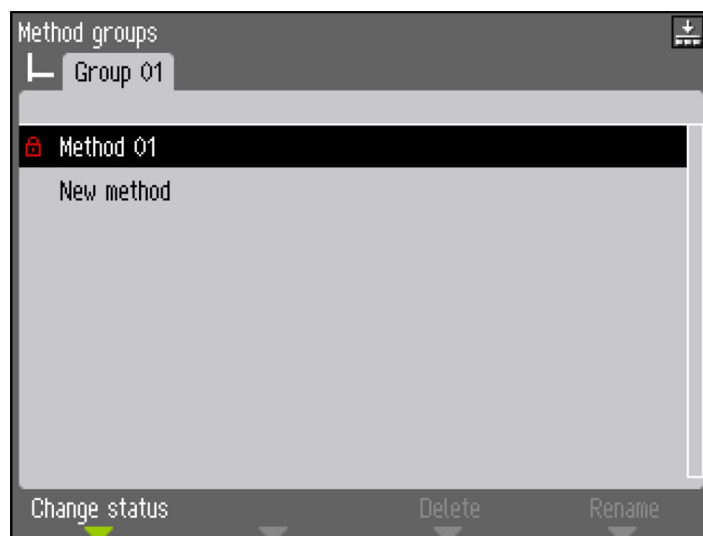

The lock symbol in front of the method name has now changed status and shows the locked method. This method can still be modified, but when saving any changes, it is only possible to select **Save method as**.

6.8 Reset functions

It may be necessary to reset certain functions to factory settings using the **Reset functions** menu. For example, when exchanging dosing modules which have a different pump configuration (e.g. mounting a dosing module with 1 DP pump in place of a 2 DP dosing module).

1. From the **Main menu**, select **Maintenance**.

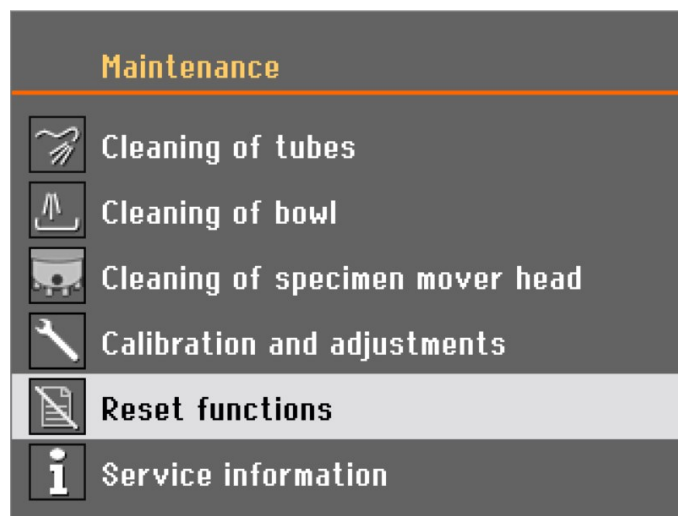

2. Select **Reset functions**.

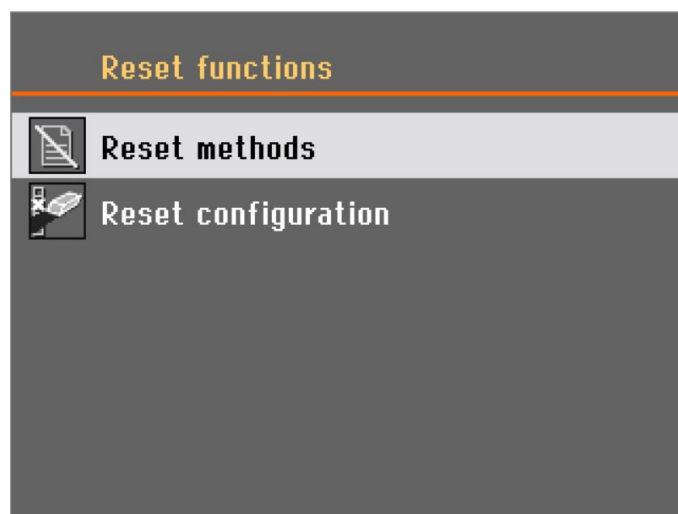

In the **Reset functions** menu, you have the following options:

- **Reset methods**
- **Reset configuration**

6.8.1 Reset methods

In the **Reset methods** screen, you have 2 different options:



- **Reset methods in one group**
- **Reset methods in all groups**

Select the function you need to reset.

Note
If you reset methods, they are deleted and you cannot reestablish them.

6.8.2 Reset configuration

To reset you configuration data. to default parameters:

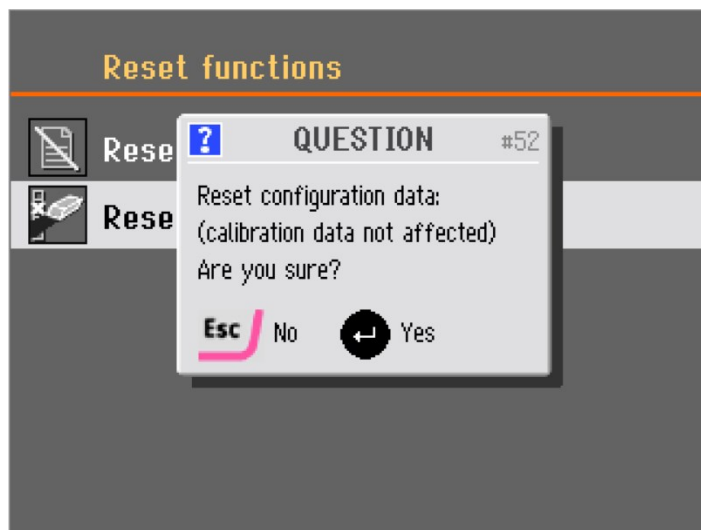

1. Select **Reset configuration**.
2. Restart the machine.

3. Reconfigure the settings.

**Note**

You need to turn the machine off and on again before resetting the configuration data.

**Hint**

We recommend that you make a note of your own customized settings under **Options** or **Bottle configuration** before you reset the configuration.

7 Operate the device

7.1 Start the preparation process

**WARNING**

The operator must read the safety precautions and Instruction Manual, as well as relevant sections of the manuals for any connected equipment and accessories.

**WARNING**

When the disc is rotating, make sure your hands are kept completely clear of its periphery and out of the splash bowl.

**CAUTION**

Always use goggles, gloves and other recommended protective clothing.

Tegramin without cover

1. Select a method.
2. Press Start.

Tegramin with cover

1. Select a method.
2. Close the cover.
3. Press Start.

7.2 Stop the process

The process stops automatically when the set preparation time has expired.

- To stop the process before the set preparation time has expired, press Stop.

7.3 The spin function

Use the built-in spin function:

- To remove water from a SiC Foil/SiC Paper before you remove it.
- To dry a preparation disc or an MD-Chem polishing cloth.



To start the spin function, press and hold the Disc rotation button.

To stop the spin function, release the Disc rotation button.

7.4 The specimen mover

The specimen mover can be used with specimen mover plates for single specimens.

7.4.1 Mount the specimens in a mover plate

1. Place the specimens in the holes to the front.
2. Use the Rotate key on the control panel to rotate the mover plate 180°.
3. Repeat until all specimens are placed and all holes are used.



Note

The height of the specimen should be between 8 - 35 mm and not exceed 0.7 x specimen diameter. For example, a specimen with a diameter of 30 mm must not be higher than 21 mm (30 x 0.7).

7.4.2 Insert a specimen mover plate

1. Press the Lower/Raise button to make sure that the specimen mover head is fully raised.
2. Loosen the Allen screw on the mover head using a 4 mm Allen key.
3. Insert the specimen mover plate and rotate it until the two pins are aligned.
4. Push the specimen mover plate upwards until it locks in position.
5. Release the black button on the specimen mover head. Make sure that the specimen mover plate is securely fixed.

7.4.3 Lower the specimen mover head



WARNING

Keep your hands clear of the specimen mover plate when lowering the specimen mover.

To lower the specimen mover head when you are using a specimen mover plate:

- Press the Raise/Lower button to lower the specimen mover head into position ready for preparation. The distance between the preparation disc and the specimen mover plate should be about 2 mm.

To adjust the distance, see [Adjust the height of the specimen mover plate](#) ▶55.

7.4.4 Adjust the height of the specimen mover plate

Main menu

1. From the **Main menu**, select **Maintenance**.
2. Select **Calibration and adjustments**.

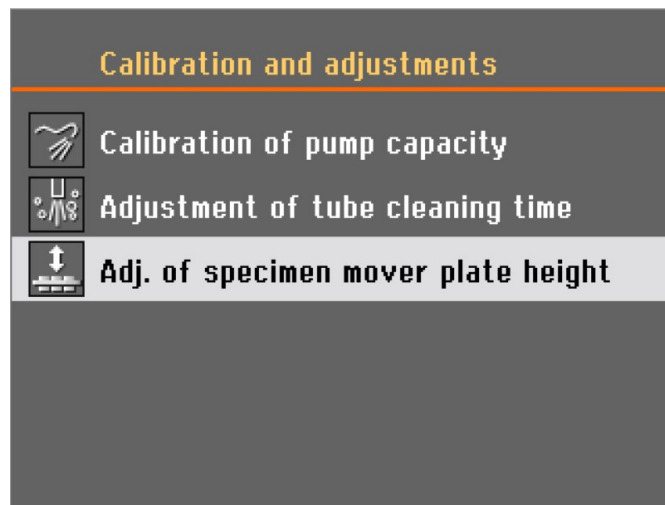

3. Select **Adj. of specimen mover plate height**.

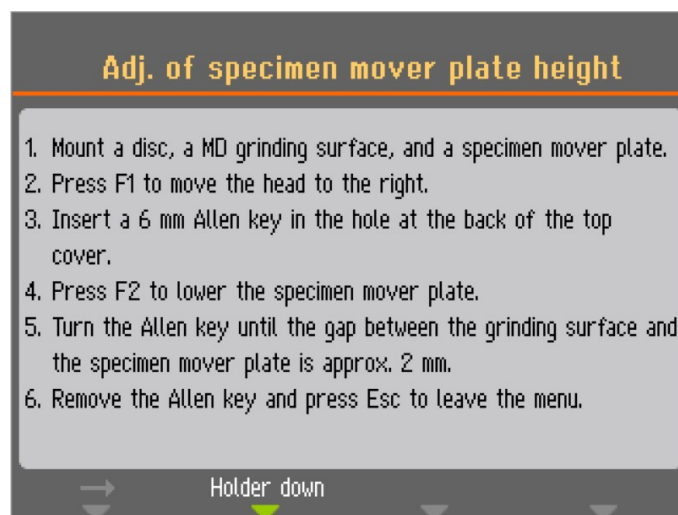

4. Follow the on-screen instructions.
5. Turn the Allen key clockwise to increase the gap.
Turn the Allen key counter-clockwise to reduce the gap.



6. Remember to remove the Allen key before you use the machine.

7.4.5 Adjust the horizontal position of the specimen mover plate

To adjust the horizontal position of the specimen mover plate over the preparation disc:

1. Loosen the screw on the mover head using a 4 mm Allen key.
2. Move the mover head to the left or the right to adjust the horizontal position.
3. Fasten the screw and make sure that the specimen mover head is securely fixed.

Position the specimenmover plate so that the specimens run 3 - 4 mm over the edge of the preparation disc.

7.4.6 Recommendations for grinding single specimens

Do not use plane grinding with coarse abrasives when preparing single specimens. It is normally not necessary, and the use of coarse abrasives can result in uneven specimens.

If you need to grind using coarse abrasives, follow these recommendations to improve the planeness of your specimens:

- Use the smallest grain size possible (bear in mind that this will increase the overall preparation time).
- Use a mounting resin with a wear resistance similar to the specimens wear resistance.
- Use 150 rpm for both the grinding disc and specimen mover. When using lower speeds, decrease the speed on both the disc and the specimen mover.
- Use co-rotation. Both the disc and the specimen mover head rotate counterclockwise.
- Use low force.
- Position the specimen mover head so that the specimens do not pass over the center of the preparation disc.
- Lower the specimen mover plate as much as possible, without coming into contact with the preparation surface.

7.5 Manual preparation

If you cannot prepare a specimen by using a standard specimen mover plate or specimen holder, you can prepare it manually.

When you perform manual preparation, you hold the specimen in your hand and press it firmly onto and across the preparation surface.



WARNING

Wear suitable gloves to protect fingers from abrasives and warm/sharp specimens.



WARNING

When you perform manual grinding or polishing, be careful not to touch the disc.



WARNING

Do not try to collect a specimen from the tray while the disc is rotating.



WARNING

When the disc is rotating, make sure your hands are kept completely clear of its periphery and out of the splash bowl.



WARNING

Always use goggles, gloves and other recommended protective clothing.

Procedure

1. From the **Main menu**, select **Manual preparation**.

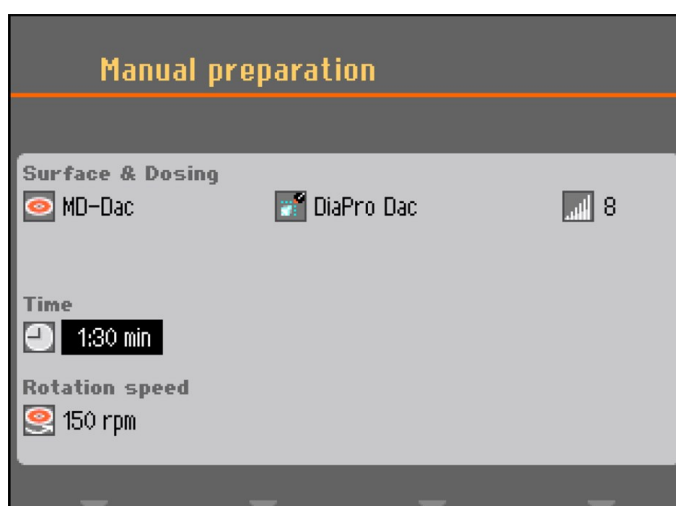

2. Set the parameters and consumables you want to use.

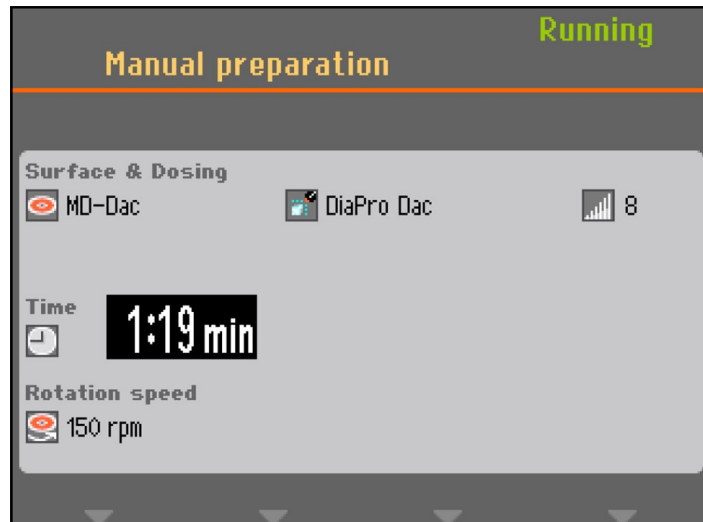

3. Press Start.
 - The disc will start turning at the preset speed and dosing will commence.
 - The preparation stops automatically when the preset time expires.

**Note**

If you want to stop the disc and/or dosing before the time has expired, press Stop.

8 Maintenance and service

Proper maintenance is required to achieve the maximum up-time and operating lifetime of the machine. Maintenance is important in ensuring continued safe operation of your machine.

The maintenance procedures described in this section must be carried out by skilled or trained personnel.

Safety Related Parts of the Control System (SRP/CS)

For specific safety related parts, see the section "Safety Related Parts of the Control System (SRP/CS)" in the section "Technical data" in this manual.

Technical questions and spare parts

If you have technical questions or when you order spare parts, state serial number and voltage/frequency. The serial number and the voltage are stated on the name plate of the machine.

8.1 Clean the machine

8.1.1 General cleaning

To ensure a longer lifetime for your machine, we strongly recommend regular cleaning.



Note

Do not use a dry cloth as the surfaces are not scratch resistant. Grease and oil can be removed with ethanol or isopropanol.



Note

Do not use acetone, benzol or similar solvents.

If the machine is not to be used for a longer period of time

- Clean the machine and all accessories thoroughly.

8.2 Daily

- Clean all accessible surfaces with a soft, damp cloth.
- Check the bowl liner and clean or dispose of it when it is filled with debris.

8.2.1 Clean the bowl

1. From the **Main menu**, select **Maintenance**.

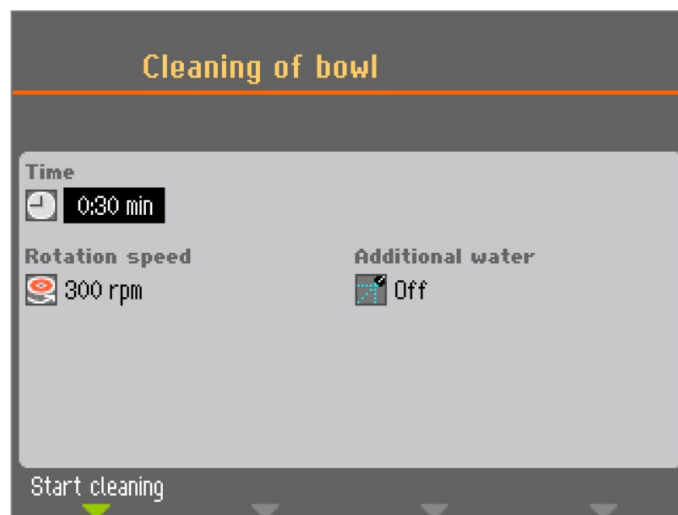

2. Select **Cleaning of bowl**.
3. Set the cleaning time, disc speed, and additional water, if necessary.
4. Press F1 to start the cleaning process.

**Note**

If a bowl liner is used, remove it before you start the **Cleaning of bowl** function to avoid flushing the debris into the drain.

8.3 Weekly

1. Clean all accessible surfaces with a soft damp cloth and common household detergents.
2. For heavy duty cleaning, use Struers Cleaner.
3. Remove the preparation tube and the bowl liner. See [Clean the bowl ▶59](#).
4. Remove all dirt from the drain tube.
5. Clean or replace the bowl liner, and insert a clean or new one.
6. Put the preparation disc in place.
7. Clean the pressure feet and pistons applying the force on the specimens and specimen holder. See also: [Clean the specimen mover head ▶61](#).
8. Drain the water/oil filter. See also: [Empty the water/oil filter ▶62](#)

**Note**

Make sure that the cleaning water is not drained into the recirculation unit (if any).

Tegramin with cover or safety cover

- Clean the cover or safety cover with a damp, soft cloth and a household anti-static window cleaner.

8.3.1 Clean the tubes

Clean the tubes weekly, or every time you change or replace the bottles to prevent remaining suspension or lubricant from interfering in the preparation process.

Procedure

1. From the **Main menu**, select **Maintenance**.
2. Select **Cleaning of tubes**.
3. Select F4 to select all the tubes that have been used.

If you need to select or deselect a single tube, use the cursor to move to the respective tube, and press the knob.

| Cleaning of tubes | | | |
|-------------------|-----------------------|--------|------------|
| No. | Susp./Lub. name | Status | Select |
| 1 | DiaPro All/Lar. | Clean | No |
| 2 | DiaPro Largo | Clean | No |
| 3 | DiaPro Dac | Used | Yes |
| 4 | DiaPro Dur | Clean | No |
| 5 | DP-Suspension, P 3 µm | Used | Yes |
| 6 | DP-Lubricant, Blue | Used | No |
| 7 | DP-S | Clean | No |

Start cleaning Select "Used"

- When you have selected the tubes to be cleaned, select F1 to start the cleaning process.
- Follow the on-screen instructions to complete the operation.

8.3.2 Clean the specimen mover head

Use the **Cleaning of specimen mover head** to clean the feet applying force onto the specimens, and the lock that secures the specimen mover plate for single specimens.

Procedure

- From the **Main menu**, select **Maintenance**.
- Select **Cleaning of specimen mover head**.

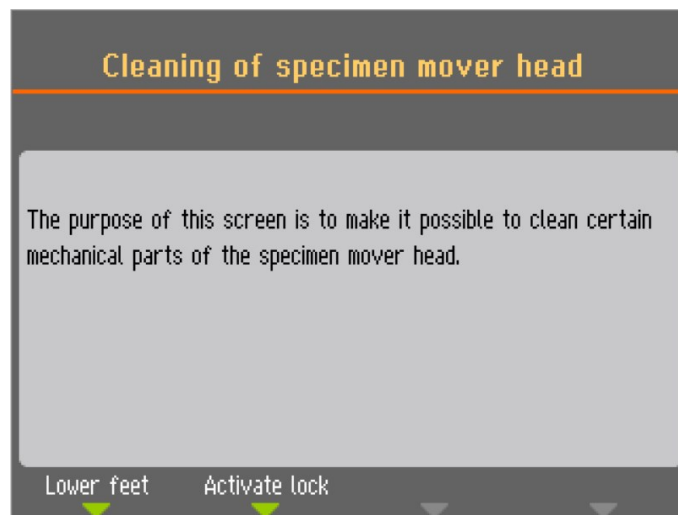

- Select F1 to lower the feet and clean or lubricate the pistons.
- Select F2 to activate the lock.

 **Note**
Do not try to force any of the movements. If the components do not move as they should, contact Struers Service.

8.3.3 Empty the water/oil filter

The machine is fitted with a water/oil filter that removes excessive amounts of water and oil from the compressed air supply.

Empty the filter on a regular basis.

Procedure

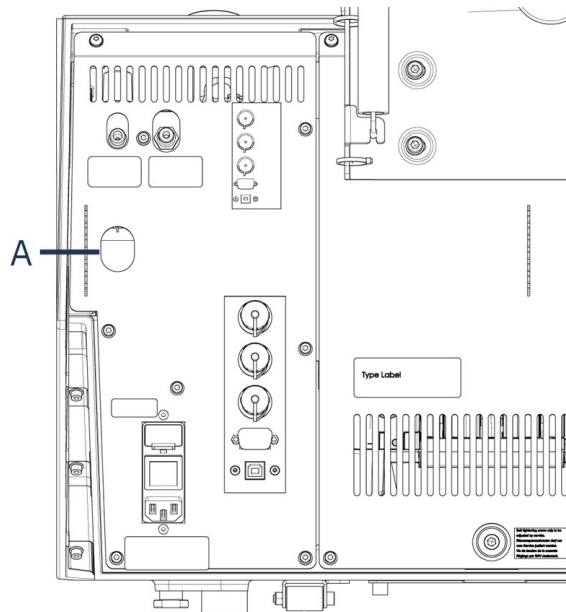

A Release outlet valve

1. Locate the release outlet valve at the rear of the machine.
2. Hold a cloth under the release outlet valve and press the valve to empty the water/oil filter.

8.4 Annually

8.4.1 Test the safety devices

The safety devices must be tested at least once a year.

 **WARNING**
Do not use the machine with defective safety devices.
Contact Struers Service.

 **WARNING**
Safety critical components must be replaced after a maximum lifetime of 20
Contact Struers Service.

**Note**

Testing should always be performed by a qualified technician (electromechanical, electronic, mechanical, pneumatic, etc.).

Emergency stop

1. Press the Start button. The machine starts operating.



2. Press the emergency stop.



3. If operation does not stop, press the Stop button.
4. Contact Struers Service.

8.5 When necessary

8.5.1 Calibrate pump capacity

The amount of liquid delivered onto the preparation surface can change over time. You can calibrate each pump individually to keep a constant dosing level.

For highest precision we recommend calibrating the pump capacity every 3 months, as well as each time the tubes are changed.

Procedure

1. From the **Main menu**, select **Maintenance**.

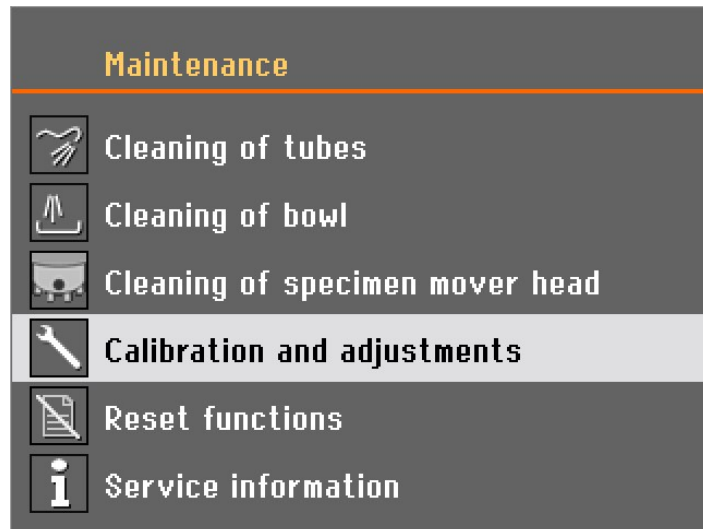

2. Select **Calibration and adjustments**.

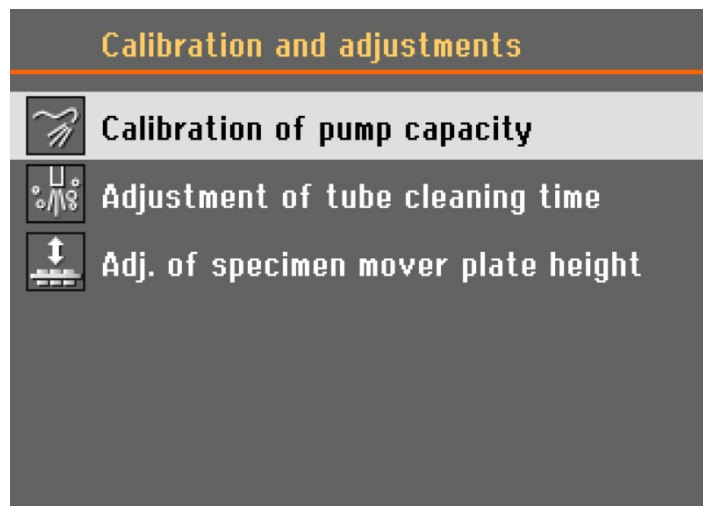

3. Select **Calibration of pump capacity**.

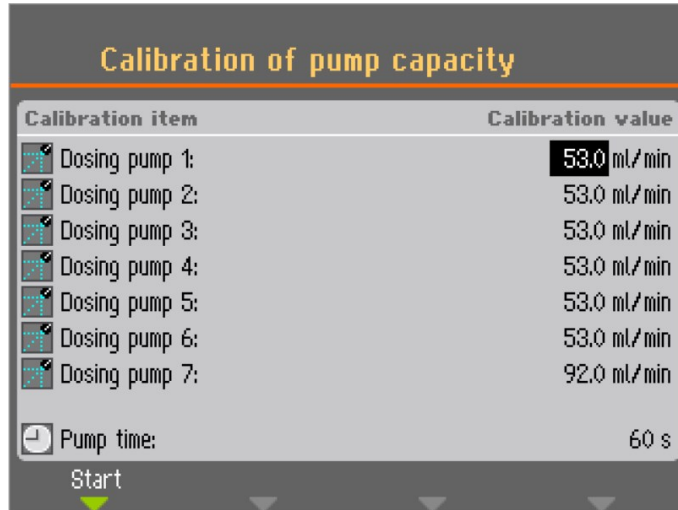

4. Select the pump to be calibrated.
5. Exchange the bottle in the selected pump position with a container with water, and select F1 to start the pump.
6. When the water coming out of the nozzle is clear, press F1 to stop the pump.
7. Place an empty measuring cylinder under the dosing nozzle. For highest accuracy, weigh the measuring cylinder.
8. Press F1 to start the calibration process. The pump runs for 60 seconds.
9. When the pump stops, measure the volume of water in the container or weigh the measuring cylinder again.

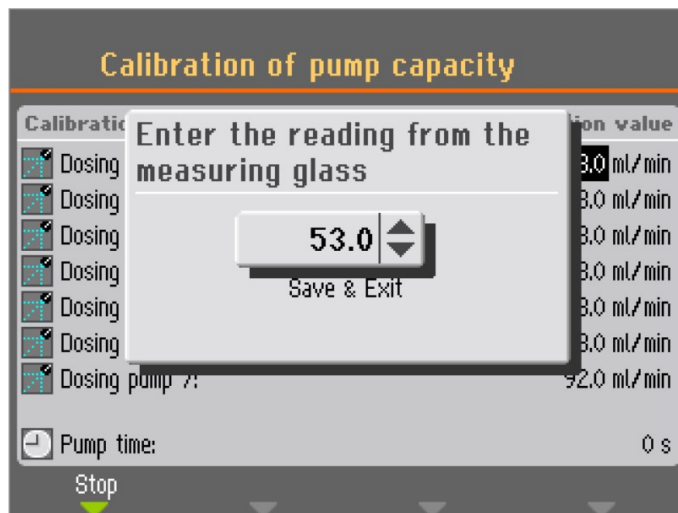

10. Enter the measured amount of water, and confirm the new value by selecting **Save & Exit**.

The machine recalculates the dosing levels based on the value you entered.

11. If necessary, repeat the process for the other bottles.

8.5.2 Adjust the tube cleaning time

The machine is equipped with a function to specify the length of time needed to clean the whole length of the tube. These values are also used when refilling the tube with suspension or lubricant after a tube cleaning. Therefore, the cleaning times can be adjusted e.g. if the tubes have been shortened after installing the dosing units.

To adjust the tube cleaning time:

1. From the **Main menu**, select **Maintenance**.

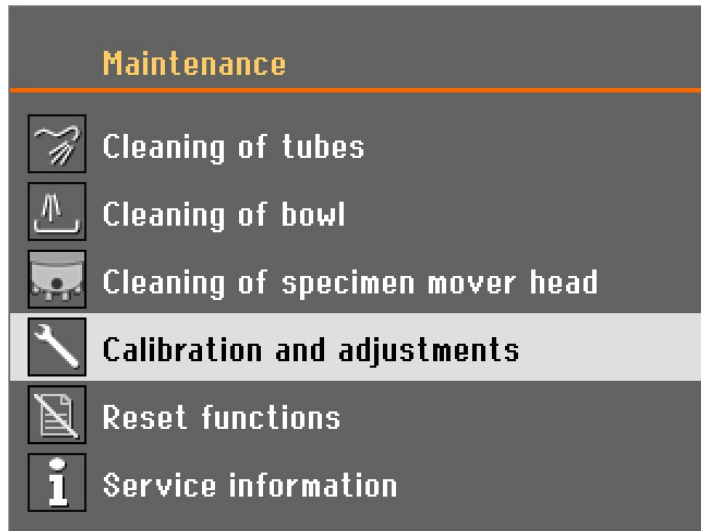

2. Select **Calibration and adjustments**.

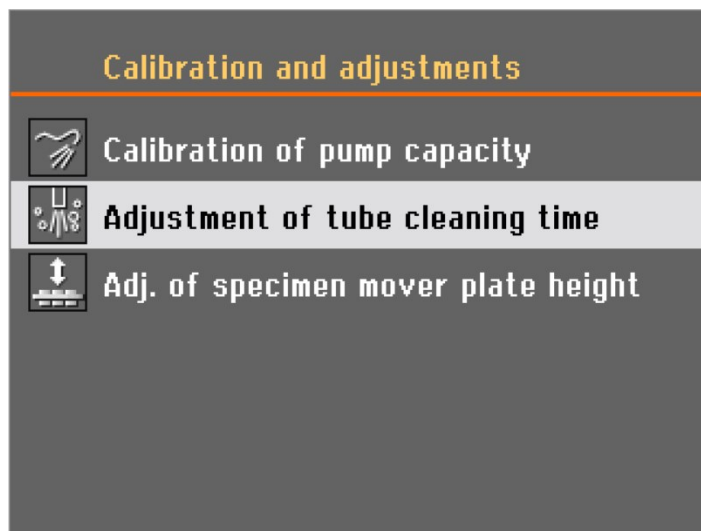

3. Select **Adjustment of tube cleaning time**.

| Adjustment of tube cleaning time | |
|---|----------|
| Setup item | Settings |
| Pump 1-6, time from empty to filled tube: | 9.0 s |
| Pump 1-6, cleaning time: | 30.0 s |
| Pump 7, time from empty to filled tube: | 17.0 s |
| Pump 7, cleaning time: | 30.0 s |
| Pump 7, time from T-pipe to nozzle: | 9.0 s |

Default value

Time from empty to filled tubes - pumps 1-6

Increase the time if:

- Diamond suspensions or lubricants do not reach the dosing nozzles after a cleaning process before you start a preparation step

Decrease time if:

- Diamond suspension or lubricant is dosed before the pre-dosing is started.

Time from empty to filled tubes- pump 7

Increase the time if:

- OP suspension does not reach the dosing nozzles after a cleaning process before you start a preparation step.

Decrease time if:

- Too much OP suspension is dosed before the pre-dosing is started.

Cleaning time

You can set the cleaning time for all tubes. The cleaning time specifies the time a pump runs during a cleaning cycle.

Time from T-pipe to nozzle - pump 7 only

You can also set the time from the T-pipe, where the water for flushing is added, to the nozzle.

8.5.3 Change the tubes

When you use alcohol-based lubricants, the Novoprene tubes mounted in the pumps will harden over time. Silicone has a better resistance against alcohol.

You can replace the tubes with the set of silicone tubes supplied with the unit.

1. Separate the dosing tubes at the white coupling. The coupling must remain on the tube connected to the machine.

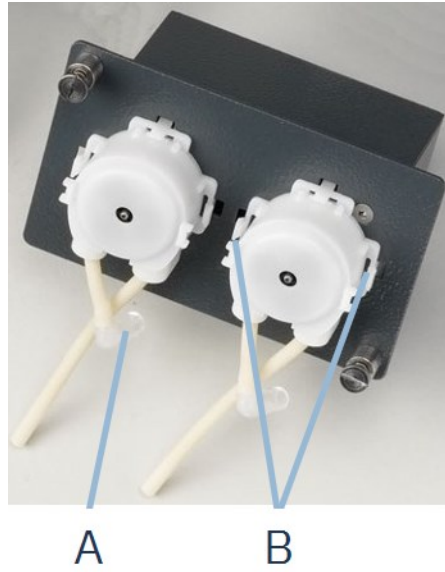

2. Disconnect the opposite end of the tube from the machine.(A)
3. Press the two tabs at the base of the pump (B), and remove the pump from the shaft.

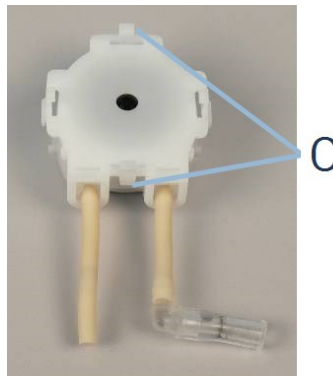

4. Press the two tabs on the pump (C), and remove the bottom cover.

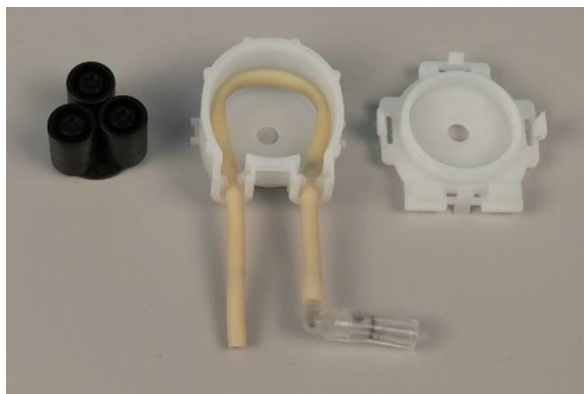

5. Remove the three rollers.
6. Remove the Novoprene tube.

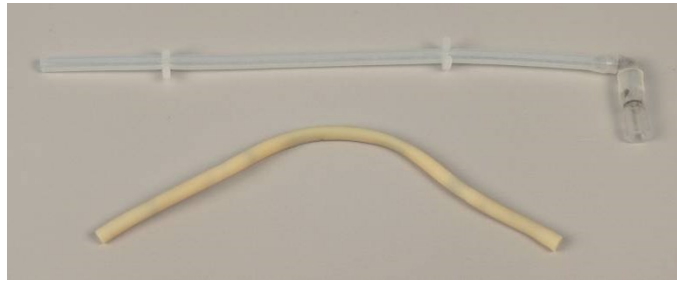

7. Make a note of the distance between the two white clips on the Novoprene tube.
8. Move the white clips and the connector to the new silicone tube.
9. Fit the new tube into the housing and press it firmly into place.
10. Press the three rollers into the pump housing.



11. Remount the bottom cover.
12. Press the pump back onto the axle.
13. Reconnect the tubes.
14. Make sure that the tubes are connected correctly so that liquid is pumped to the machine.

8.6 The Service information menu

Service information is read-only information. The machine settings cannot be changed.

Service information can be used in cooperation with Struers Service for remote diagnostics of the equipment.

The service information is available only in English.

Information on total operation time and servicing of the machine is displayed on the screen at start-up.

8.7 Spare parts

For specific safety related parts, see the section "Safety Related Parts of the Control System (SRP/CS)" in the section "Technical data" in this manual.

Technical questions and spare parts

If you have technical questions or when you order spare parts, state the serial number and the year of production. This information is stated in the name plate on the machine.

For further information, or to check the availability of spare parts, contact Struers Service. Contact information is available on Struers.com.

8.8 Service and repair

We recommend that a regular service check be carried out yearly or after every 1500 hours of use.

When the machine is started up, the display shows information about total operation time and the machines service information.

After 1500 hours of operation time, the display will show a message reminding the user that a service check should be scheduled.



Note

Service must only be performed by a qualified technician (electromechanical, electronic, mechanical, pneumatic, etc.).
Contact Struers Service.

9 Disposal



Equipment marked with a WEEE symbol contains electrical and electronic components and must not be disposed of as general waste.

Contact your local authorities for information on the correct method of disposal in accordance with national legislation.

For disposal of consumables and recirculation fluid, follow local regulations.



WARNING

In case of fire, alert bystanders, the fire brigade and cut power. Use a powder fire extinguisher. Do not use water.

**Note**

The recirculation fluid will contain additive and cutting or grinding swarf. Do not dispose of the recirculation fluid into a main drain. Follow the current safety regulations for handling and disposal of swarf and additive for recirculation fluid.

Keep track of which metals you cut or grind and the amount of swarf produced.

Depending on which metals you cut or grind, it is possible that the combination of the metallic swarf from metals with a large difference in electropositivity, can result in exothermic reactions when favorable conditions are present.

Examples:

The following are examples of combinations which can result in exothermic reactions if a large amount of swarf is produced during cutting or grinding on the same machine, and when favorable conditions are present:

- Aluminum and copper.
- Zinc and copper.

10 Troubleshooting

10.1 Grinding and polishing problems

| Error | Cause | Action |
|--|---|---|
| Noise when the machine starts, or the turntable will not turn. | The belt is not tight enough. | The belt must be tightened. Contact Struers Service. |
| The machine does not operate when the start switch is pressed. | The main switch is off. | Turn the main switch on. |
| | The fuse is blown (located at the back of the machine). | Replace the fuse. |
| Water is not draining away. | Drain hose squeezed. | Straighten the hose. |
| | Drain hose clogged. | Clean the hose. |
| | Drain hose does not slope downwards. | Adjust the hose to an even slope. |





| Error | Cause | Action |
|---|--|---|
| Cooling water stops. | Water tap on water supply closed. | Turn the water on. |
| | Built-in water tap closed. | Turn the water on. |
| | Built in water tap blocked | Clean water tap. |
| | Filter at the water inlet blocked | Clean the filter with compressed air only. |
| | Wrong software setting. | Check the software settings. |
| Insufficient water flow of water. | Built-in water tap blocked. | Clean the water tap. |
| | Filter at the water inlet blocked. | Clean the filter. |
| | Water valve needs to be adjusted. | See Adjust the water flow ▶24. |
| Cooling water drips after stop. | Defect in the solenoid valve. | The solenoid valve must be replaced. Contact Struers Service. |
| Continuous, irregular wear on a grinding / polishing surface. | Worn coupling on either specimen holder / mover plate or the specimen mover head of the machine. | The coupling must be replaced. Contact Struers Service. |
| The preparation disc runs unevenly or stops. | The force is too high. | Reduce the force. |
| The preparation disc stops. | The frequency inverter has stopped the equipment. | Switch the machine off. Wait for a few minutes, then restart the machine. If the error remains, contact Struers Service. |
| | The specimens are wider than the radius of the preparation disc. | Use smaller specimens. |
| Uneven specimens. | The specimens are passing over the centre of the disc. | Reposition the horizontal position of the specimen holder / specimen mover plate. See Adjust the horizontal position of the specimen mover plate ▶56. |





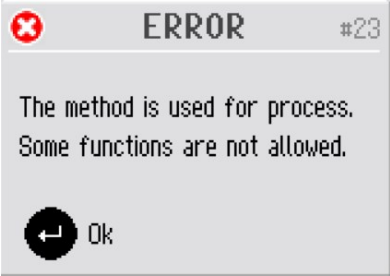
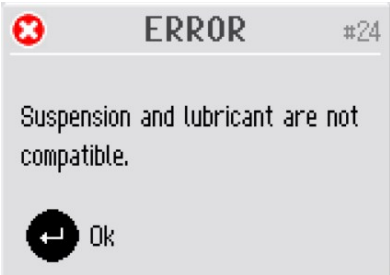

10.2 Error messages





Errors must be corrected before operation can be continued.



Press **Enter** to acknowledge the error/message.

| # | Error message | Explanation | Action |
|----|---------------|---|---|
| 1 | | The emergency stop is activated. | Deactivate the emergency stop. |
| 13 | | The name you want to use for a group of methods exists already. | Use a different name for the group. |
| 14 | | The name you want to use for a method exists already. | Use a different name for the method. |
| 15 | | The name you want to use is reserved by the machine. | Use a different name. |
| 19 | | The specimen holder head must be in the top position to continue. | Press Enter to acknowledge the message, then move the specimen holder head to the top position. |

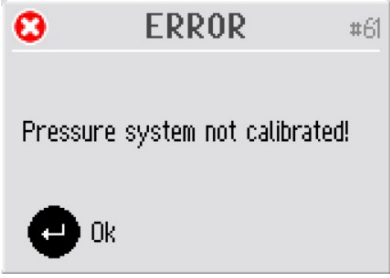

| # | Error message | Explanation | Action |
|----|---|---|---|
| 23 |  | The method is in use and some parameters cannot be changed, and some functions are unavailable. | <p>Press Enter to acknowledge the message.</p> <p>Wait until the process is finished.</p> |
| 24 |  | As user defined consumables are not divided into product groups, it is possible to combine a user-defined suspension with an incompatible user-defined lubricant. | <p>Press Enter to acknowledge the message and choose a lubricant that is compatible with the selected suspension or change the lubricant type for the user-defined lubricant. This is done in the User lubricant configuration screen, in the Configuration menu.</p> |
| 25 |  | When you create a method, it is not possible to combine a user defined suspension with an incompatible surface. | <p>Press Enter to acknowledge the message and choose a different suspension (or surface).</p> |
| 35 |  | The name you want to use for a consumable exists already. | <p>Press Enter to acknowledge the message.</p> <p>Use a different name for the consumable.</p> |
| 38 |  | | <p>Change the operation mode to Development or Configuration.</p> |

| # | Error message | Explanation | Action |
|----|--|--|--|
| 40 |  <p>Function disabled in the screen "Options".</p> <p>Ok</p> | The Level measuring in bottles function has been set to No in the Options screen. | To activate Level measuring in bottles : Go to the Options menu and select Yes . Then return to the Bottle configuration menu and set the actual remaining level of liquid for all the configured bottles. |
| 43 |  <p>Manual dosing not allowed from this menu.</p> <p>Ok</p> | Function not available in the current menu. | Press Enter to acknowledge the message. Select a method and select a step containing the consumable to be dosed. |
| 47 |  <p>Tube(s) not selected for cleaning, please use the turn-push-button to select tube(s).</p> <p>Ok</p> | No tubes have been selected for cleaning yet. | Press Enter to acknowledge the message. Select the tube(s) you want to clean, then select cleaning again. |
| 56 |  <p>Emergency stop activated, but 24V DC control power is not disconnected! Please call service technician.</p> <p></p> | The emergency stop has been activated, but the 24V control power is not disconnected. | Contact Struers Service. |
| 57 |  <p>Emergency stop activated, but 24V DC control power is constantly disconnected! Please call service technician.</p> <p></p> | The emergency switch has been activated, but the 24V control power is constantly disconnected. | Contact Struers Service. |

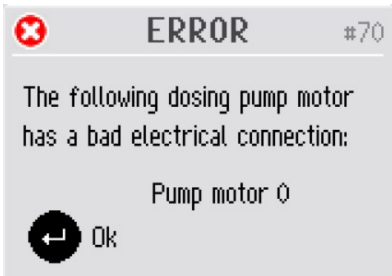
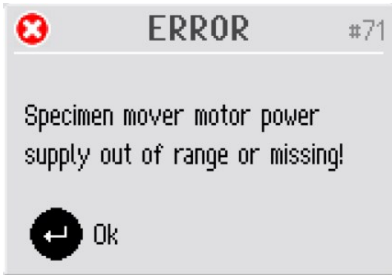

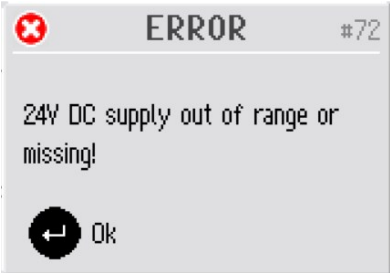
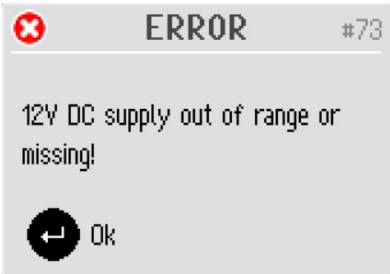
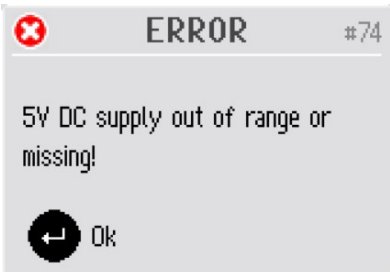
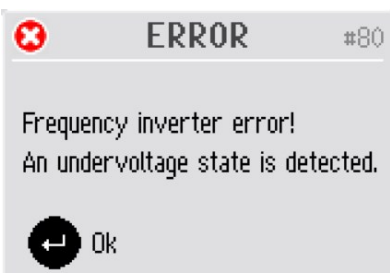
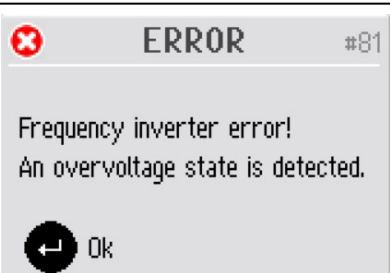

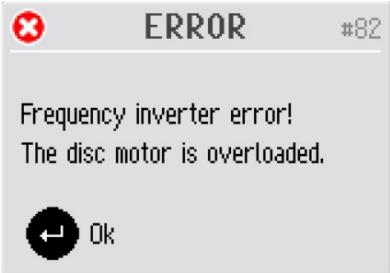
| # | Error message | Explanation | Action |
|----|---|--|---|
| 59 |  | There is a failure in the compressed air supply. | <p>Press Enter to acknowledge the message.</p> <p>Check and re-establish the compressed air supply.</p> |
| 60 |  | There is a failure in the pressure regulator. | <p>Check the compressed air supply and restart the machine.</p> <p>If the error remains, contact Struers Service.</p> |
| 61 |  | The pressure system is not calibrated correctly. | <p>Press Enter to acknowledge the message.</p> <p>Restart the machine.</p> <p>If the error remains, contact Struers Service.</p> |
| 64 |  | After pressing stop or when the preparation time expired, the preparation disc did not stop. | <p>Press Enter to acknowledge the message.</p> <p>Use the emergency stop to stop the disc. Restart the machine.</p> <p>If the error remains, contact Struers Service.</p> |

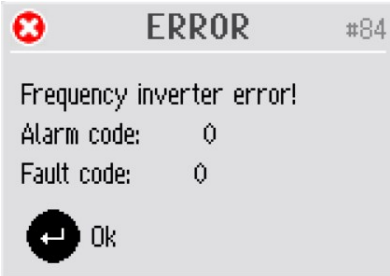
| # | Error message | Explanation | Action |
|----|---|---|---|
| 68 |  | The specimen holder motor is driven by the preparation disc. | <p>Press Enter to acknowledge the message.</p> <p>Position the specimen holder more to the left (to reduce the friction force) or reduce the force and/or the disc motor speed.</p> <p>Press START again.</p> <p>If the error remains, contact Struers Service.</p> |
| 69 |  | The end stops of the specimen mover head are not adjusted correctly. | Contact Struers Service. |
| 70 |  | There is no electrical connection to the pump mentioned. | <p>Press Enter to acknowledge the message.</p> <p>Switch off the machine. Remove the pump module in question and slide back in position again.</p> <p>Restart the machine.</p> <p>If the error remains, contact Struers Service.</p> |
| 71 |  | The power supply for the specimen mover motor is too high or too low (24 V DC +/- 10%). | <p>Press Enter to acknowledge the message.</p> <p>Restart the machine.</p> <p>If the error remains, contact Struers Service.</p> |

| # | Error message | Explanation | Action |
|----|---|--|---|
| 72 |  | 24 V DC supply voltage out of 10% range. The power supply must be adjusted or exchanged. | <p>Press Enter to acknowledge the message.</p> <p>Restart the machine.</p> <p>If the error remains, contact Struers Service.</p> |
| 73 |  | 12 V DC supply voltage out of 10% range. The PCB might be damaged. | <p>Press Enter to acknowledge the message.</p> <p>Restart the machine.</p> <p>If the error remains, contact Struers Service.</p> |
| 74 |  | 5 V DC supply voltage out of 10% range. The PCB might be damaged. | <p>Press Enter to acknowledge the message.</p> <p>Restart the machine.</p> <p>If the error remains, contact Struers Service.</p> |
| 80 |  | An error in the frequency inverter is detected. | <p>Press Enter to acknowledge the message.</p> <p>Check the power supply</p> <p>Restart the machine.</p> <p>If the error remains, contact Struers Service.</p> |
| 81 |  | The power supply is too high, or the frequency inverter is defective. | <p>Press Enter to acknowledge the message.</p> <p>Check the power supply.</p> <p>Restart the machine.</p> <p>If the error remains, contact Struers Service.</p> |

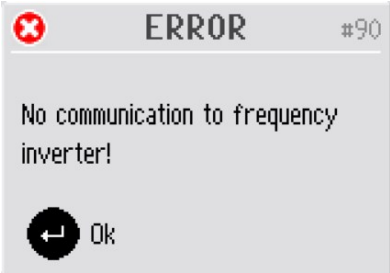
| # | Error message | Explanation | Action |
|----|--|---|--|
| 82 |  | The disc motor is overloaded, but not yet overheated. | <p>Press Enter to acknowledge the message.</p> <p>Reduce the force and continue the preparation process.</p> |
| 83 |  | The safety signal in the frequency inverter (controlled by the machine's PCB) has not been activated. | <p>Press Enter to acknowledge the message.</p> <p>Restart the machine.</p> <p>If the error remains, contact Struers Service.</p> |
| 84 |  | An error in the frequency inverter is detected. (The codes shown are refer to the frequency inverter manual.) | <p>Press Enter to acknowledge the message.</p> <p>Restart the machine.</p> <p>If the error remains, contact Struers Service.</p> <p>Make a note of the error codes to assist in finding the fault.</p> |

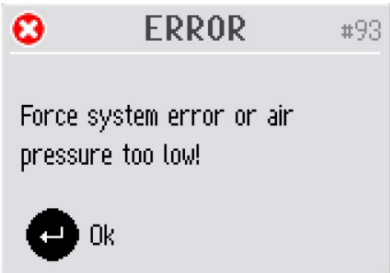
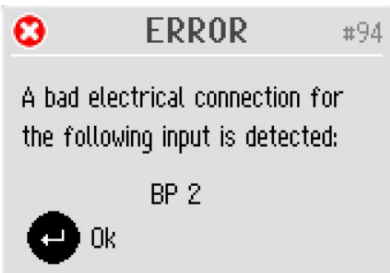
| # | Error message | Explanation | Action |
|----|---------------|---|--|
| 87 | | The sensor for the cover is not activated or defective. | <p>Press Enter to acknowledge the message.</p> <p>Open and close the cover, check for possible obstacles.</p> <p>Restart the machine.</p> <p>If the error remains, contact Struers Service.</p> <hr/> <p>Check that the cover is completely closed and press START.</p> <p>If the error remains, contact Struers Service.</p> <p>For models without a Safety cover, you can operate the machine while waiting for service.</p> <p>Go to Options and set Allow operation with cover open to Yes.</p> |
| 89 | | Electrical output error e.g. "X-motor". | <p>Press Enter to acknowledge the message.</p> <p>Restart the machine.</p> <p>In certain circumstances (depending on which module has failed) it may still be possible to operate the machine.</p> <p>If the error remains, contact Struers Service.</p> <p>Make a note of the error codes to assist in finding the fault.</p> |

| # | Error message | Explanation | Action |
|----|---|--|--|
| 90 |  | | <p>Press Enter to acknowledge the message.</p> <p>Restart the machine.</p> <p>If the error remains, contact Struers Service.</p> |
| 92 |  | <p>Air pressure too low to carry out Adjustment of specimen mover plate height.</p> | <p>Check the compressed air connection and press Enter to carry out to the adjustment, or press ESC to abort the adjustment.</p> |
| 93 |  | <p>The compressed air pressure is too low or there is a failure in the pressure regulation system.</p> | <p>Press Enter to acknowledge the message.</p> <p>Check the compressed air connection (the pressure should be between 6 and 10 Bar).</p> <p>If the error remains, contact Struers Service.</p> |
| 94 |  | <p>Electrical input error e.g. "BP 2".</p> | <p>Press Enter to acknowledge the message.</p> <p>The machine can be used to perform manual preparations but will be unable to perform automatic preparations.</p> <p>Contact Struers Service.</p> |
| 97 |  | <p>Malfunction of the emergency stop.</p> | <p>Press Enter to acknowledge the message.</p> <p>Restart the machine.</p> <p>If the error remains, contact Struers Service.</p> <p>Do not attempt to operate the machine with a defective emergency stop.</p> |

11 Technical data

11.1 Technical data

| | | |
|----------------------------|------------------------------------|---|
| Capacity | Individual specimens | Diameter: 4 x 40 mm |
| | Specimen holder | N/A |
| Disc | Diameter | 200 mm (8") |
| | Rotational speed | 40 - 600 rpm, variable in steps of 10 rpm |
| | Rotational direction | Counter-clockwise |
| | Motor power | – |
| | - Continuous (S1) | 370 W (0.5 hp) |
| | - Maximum (S3) | 500 W (0.75 hp) |
| Specimen mover head | Individual specimen | – |
| | - Force | 5 - 50 N in steps of 5 N |
| | - Specimen height | 8 - 35 mm (0.31 - 1.37") |
| | Specimen holder | N/A |
| | - Force | – |
| | - Specimens height | – |
| | Rotational speed | 50 - 150 rpm, variable in steps of 10 |
| | Rotational direction | Clockwise / counter-clockwise |
| | Motor | 120 W |
| | Torque | 7.5 N·m (5.6 ft·lbf) |
| Features | Material removal sensor (built-in) | No |
| | Methods Included | Struers Metalog Guide methods: 10 Custom made methods: max 200 |

| | | |
|---------------------------------|---------------------------------|--|
| Options | Automatic dosing, up to 7 pumps | Yes |
| | Transparent cover | Yes |
| | Safety cover | No |
| | Recirculation cooling system | Cooling System 3 |
| Software and electronics | Controls | Touch pad, Turn/push knob |
| | Display | LCD, TFT-color 5.7", 320 x 240 dots with LED back light |
| Safety standards | | CE-labeled according to EU directives |
| REACH | | For information about REACH, contact your local Struers office. |
| Operating environment | Surrounding temperature | 5 - 40°C (41 - 104°F) |
| | Humidity | 35 - 85 % RH non-condensing |
| Power supply | Voltage/frequency | 200 - 240 V (50 - 60 Hz) |
| | Power, inlet | 1-phase (N+L1+PE) or 2-phase (L1+L2+PE) The electrical installation must comply with Installation Category II |
| | Power, nominal load | 680 W |
| | Power, idle load | 9 W |
| | Current, nominal load | 3.4 A |
| | Current, maximum load | 6.3 A |
| | Current, largest load | 1.85 A |
| | Water supply | Pressure, tap water |
| | Flow, tap water | Min. 1 L/min (0.3 gpm) |
| | Water inlet, connection | Diameter: 3/4" |
| | Water outlet, connection | Diameter: 30 mm (1 1/4") |

| | | |
|--|--|---|
| Air supply | Pressure, compressed air | 6 - 9.9 bar (87 - 143 psi) |
| | Flow, compressed air | Min. 3.5 L/min (0.9 gpm) |
| | Air quality, compressed air | The air supplied must be of Class 5.6.4. or better, as specified in ISO 8573-1 |
| | Air inlet, compressed air, connection | Diameter: 6 mm (¼") |
| Exhaust (with cover only) | Connection | Diameter: 50 mm (2") |
| | Recommended capacity | 50 m ³ /h (1750 ft ³ /h) at 0 mm water gauge |
| Safety Circuit Categories/Performance Level | Emergency stop | Stop category 0, EN60204-1 PL c, Category 1, EN13849-1 |
| | Cover | Software control only. Not safety rated. |
| | Safety cover | N/A |
| Residual Current Circuit Breaker (RCCB) | | Type A, 30 mA (or better) is required |
| Noise level | A-weighted sound emission pressure level at workstations | LpA = 66 dB(A) (measured value). Uncertainty K = 4 dB(A) Measurements made in accordance with EN ISO 11202 |
| Vibration level | Declared vibration emission | Total vibration exposure to upper parts of the body does not exceed 2.5 m/s ² . |
| Dimensions and weight (without cover) | Height | 48 cm (18.9") |
| | Width | 60 cm (23.6") |
| | Depth | 65 cm (25.6") |
| | Weight | 52.5 kg (116 lbs) |
| Dimensions and weight (with cover / safety cover) | Height - cover closed / cover open | 50 cm (19.7") / 85 cm (33.5") |
| | Width | 60 cm (23.6") |
| | Depth | 65 cm (25.6") |
| | Weight | 58 kg (128 lbs) |

11.2 Safety Related Parts of the Control System (SRP/CS)



WARNING

Safety critical components must be replaced after a maximum lifetime of 20 years.

Contact Struers Service.



Note

SRP/CS (safety-related parts of a control system) are parts that have an influence on safe operation of the machine.



Note

Replacement of safety critical components must only be performed by a Struers engineer or a qualified technician (electromechanical, electronic, mechanical, pneumatic, etc.).

Safety critical components must only be replaced by components with at least the same safety level.

Contact Struers Service.

| Safety related part | Manufacturer/Manufacturer description | Manufacturer catalog no. | Struers catalog no. |
|------------------------|--|--|---------------------|
| Safety relay | Pilz 2 ch with 3s delay | PNOZ XV1P 3/24VDC 2n/o 1n/o t | 2KS10007 |
| Emergency stop button | Schlegel Latching mushroom head | ES Ø22 type RV | 2SA10400 |
| Emergency stop contact | Schlegel Modular contact, momentary | 1 NC type MTO | 2SB10071 |
| Water valve | Invesys V Series Water Valves | Solenoid valve triple 24VDC Gn.311 | 2YM12311 |
| Frequency inverter | Omron Frequency inverter 1x200V 750W | VZAB1P5BAA | 2PU12150 |
| Contactory relay | Omron Contactory 24VDC | J7KNG-14-01-24D | 2KM71411 |

11.3 Diagrams



Note

If you want to view specific information in detail, see the online version of this manual.

| Tegramin-20 | No. |
|--------------------|------------------------------|
| Block diagram | 16013052 ▶87 |
| Water diagram | 16011001 ▶88 |
| Air diagram | 16011000 ▶89 |

16013052

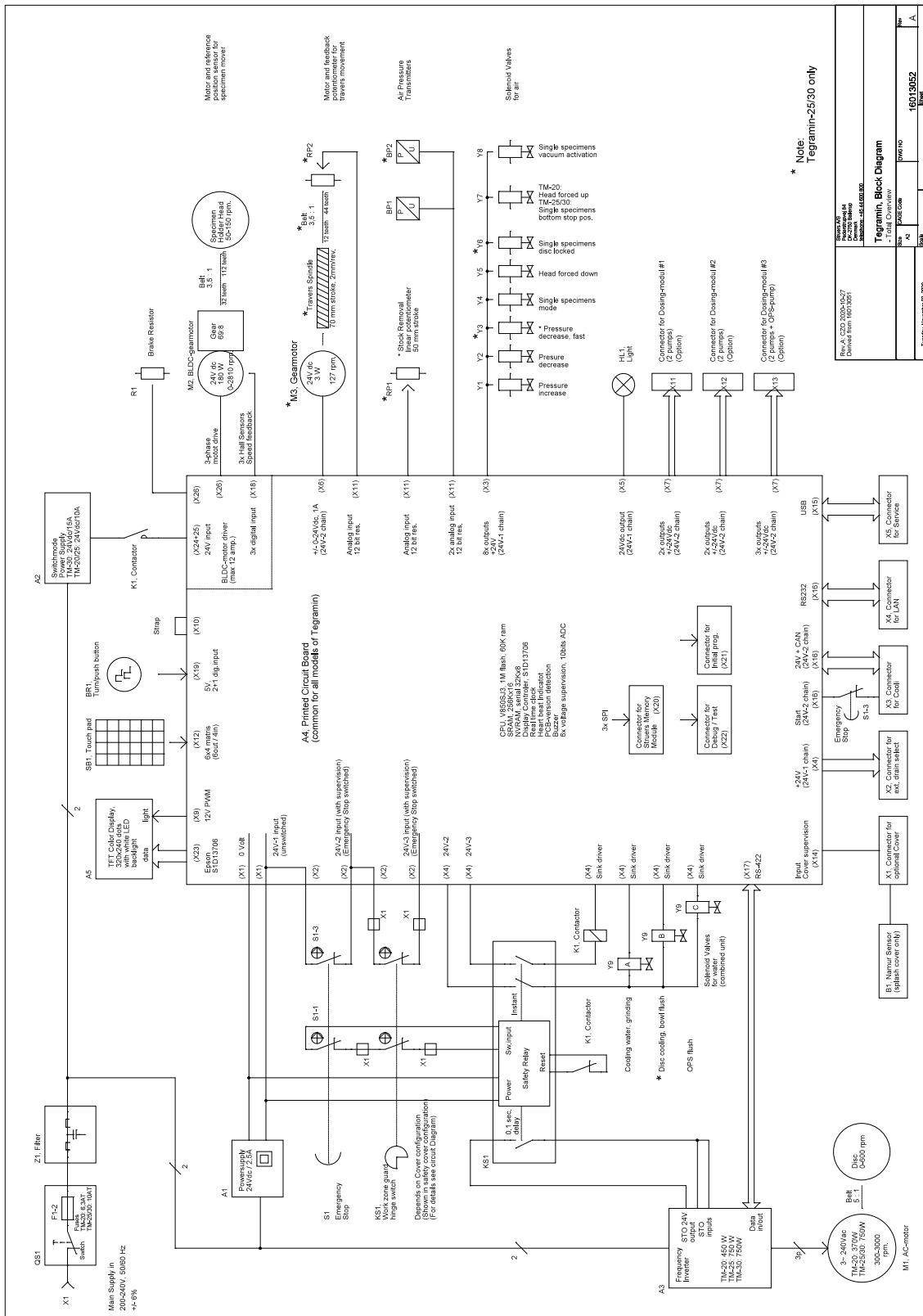

16011001

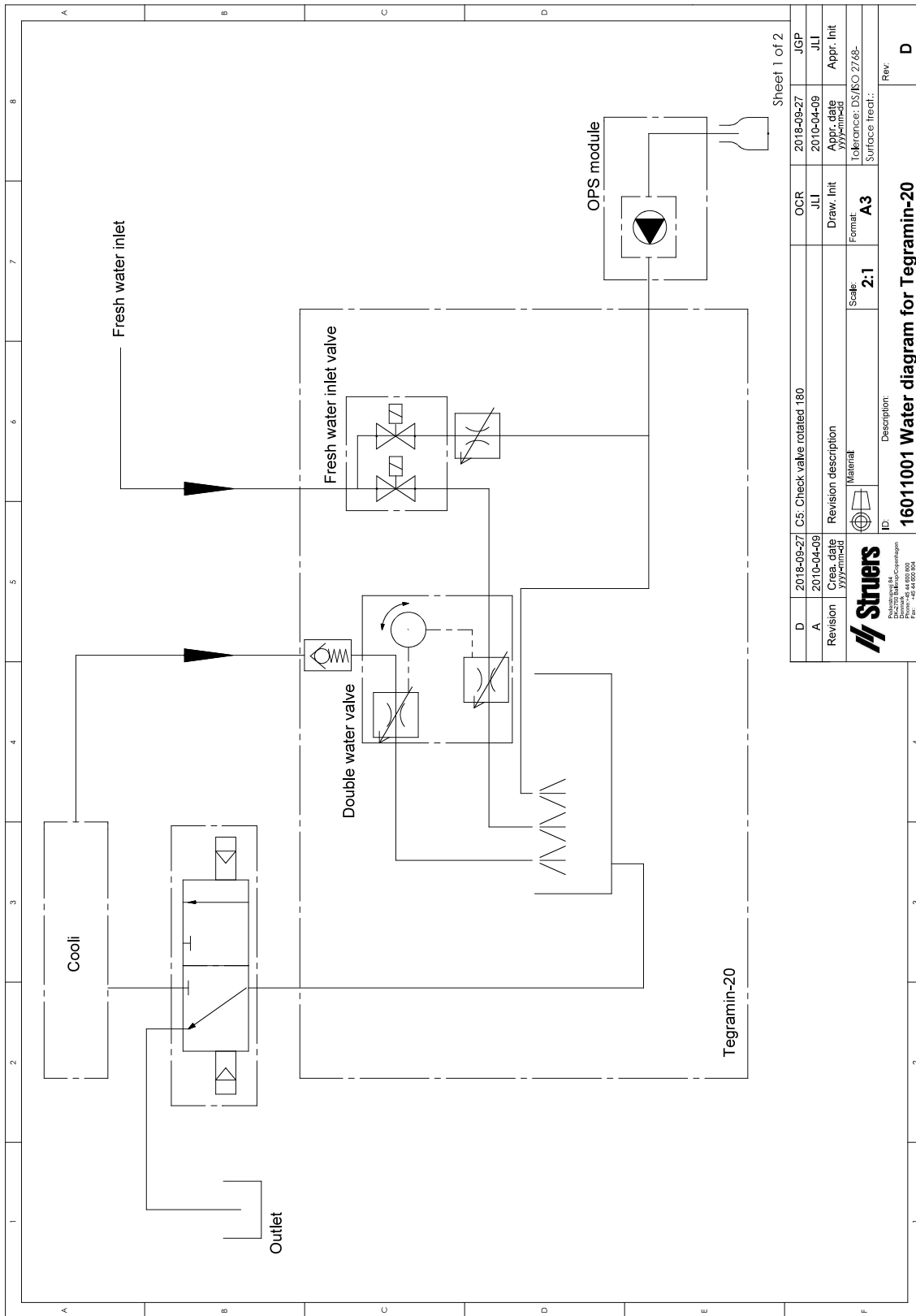

| | | | | | | |
|----------|--|------------|-----------------------------|---|--------------------------|------------|
| D | | 2018-09-27 | C5: Check valve rotated 180 | OCR | 2018-09-27 | JGP |
| A | | 2010-04-09 | | JLI | 2010-04-09 | JLI |
| Revision | | Cre. date | Revision description | Draw. Init | Appr. date | Appr. Init |
| | | yyyy-mm-dd | Material | Format: | Tolerance: DSI/ISO 2768- | |
| | | | | Scale: | Surface treat.: | |
| | | | | A3 | 2:1 | |
| | | | | ID: | Description: | Rev: |
| | | | | 16011001 Water diagram for Tegramin-20 | | |
| | | | | D | | |

16011000

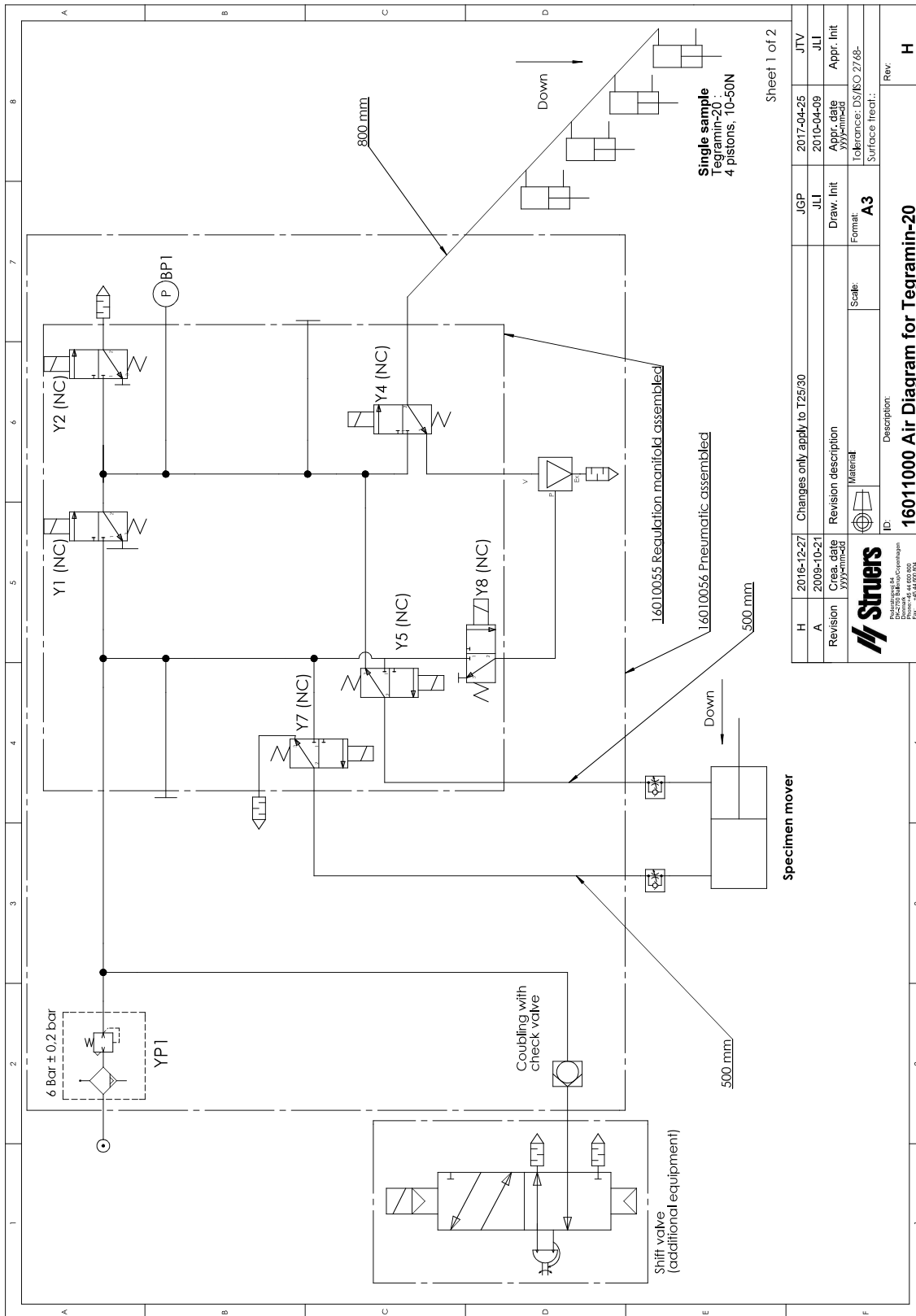

| | | | | | |
|----------|-----------------------|------------------------------|---|-------------------------|------------|
| H | 2016-12-27 | Changes only apply to T25/30 | JGP | 2017-04-25 | JTV |
| A | 2009-10-21 | Revision description | JLI | 2010-04-09 | JLI |
| Revision | Cre. date yy-mm-dd | Material | Draw. Init | Appr. date yy-mm-dd | Appr. Init |
| | | | Format: | Tolerance: D3/ISO 2768- | |
| | | | Scale: | Surface treat.: | |
| | | | ID: | Description: | Rev. |
| | | | 16011000 Air Diagram for Tegramin-20 | | |
| | | | Struers Buehlerstr. 14 DK-2600 Lyngby Denmark Tel.: +45 44 60 60 00 Fax: +45 44 60 60 04 | | |

11.4 Legal and regulatory information

FCC notice

This equipment has been tested and found to comply with the limits for a Class B digital device, pursuant to part 15 of the FCC Rules. These limits are designed to provide reasonable protection against harmful interference in a residential installation. This equipment generates, uses and can radiate radio frequency energy and, if not installed and used in accordance with the instructions, may cause harmful interference to radio communications. However, there is no guarantee that interference will not occur in a particular installation. If this equipment does cause harmful interference to radio or television reception, which can be determined by turning the equipment off and on, the user is encouraged to try to correct the interference by one or more of the following measures:

- Reorient or relocate the receiving antenna.
- Increase the separation between the equipment and receiver.
- Connect the equipment into an outlet on a circuit different from that to which the receiver is connected.

12 Manufacturer

Struers ApS
Pederstrupvej 84
DK-2750 Ballerup, Denmark
Telephone: +45 44 600 800
Fax: +45 44 600 801
www.struers.com

Responsibility of the manufacturer

The following restrictions should be observed, as violation of the restrictions may cause cancellation of Struers legal obligations.

The manufacturer assumes no responsibility for errors in the text and/or illustrations in this manual. The information in this manual is subject to change without notice. The manual may mention accessories or parts not included in the supplied version of the equipment.

The manufacturer is to be considered responsible for effects on safety, reliability, and performance of the equipment only if the equipment is used, serviced, and maintained in accordance with the instructions for use.

Declaration of Conformity

| | |
|--------------|--|
| Manufacturer | Struers ApS • Pederstrupvej 84 • DK-2750 Ballerup • Denmark |
| Name | Tegramin-20 Tegramin-25 Tegramin-30 |
| Model | N/A |
| Function | Grinding/polishing machines |
| Type | 601, 602, 603 |
| Cat. no. | 06016127, 06026127, 06016227, 06026227, 06016327, 06036127, 06016427, 06036227 In combination with: 06016905, 06036910, 06026905, 06036904, 06036905, 06016906, 06036900, 06036906, 06036901, 06016903, 06036902 06036903 |
| Serial no. | |



Module H, according to global approach



We declare that the product mentioned is in conformity with the following legislation, directives and standards:

| | |
|-----------------------------|---|
| 2006/42/EC | EN ISO 12100:2010, EN ISO 13849-1:2015, EN ISO 13849-2:2012, EN ISO 13850:2015, EN 60204-1:2018, EN 60204-1-2018/Corr.:2020 |
| 2011/65/EU | EN 63000:2018 |
| 2014/30/EU | EN 61000-3-2:2014, EN 61000-3-3:2013, EN 61000-6-2:2005, EN 61000-6-2:2005/Corr.:2005, EN 61000-6-3:2007, EN 61000-6-3-A1:2011, EN 61000-6-3-A1-AC:2012 |
| Additional standards | NFPA 79, FCC 47 CFR Part 15 Subpart B |

Authorized to compile technical file/
Authorized signatory

Date: [Release date]

en For translations see
bg За преводи вижте
cs Překlady viz
da Se oversættelser på
de Übersetzungen finden Sie unter
el Για μεταφράσεις, ανατρέξτε στη διεύθυνση
es Para ver las traducciones consulte
et Tõlked leiata aadressilt
fi Katso käännökset osoitteesta
fr Pour les traductions, voir
hr Za prijevode idite na
hu A fordítások itt érhetők el
it Per le traduzioni consultare
ja 翻訳については、
lt Vertimai patalpinti
lv Tulkojumus skatīt
nl Voor vertalingen zie
no For oversættelser se
pl Aby znaleźć tłumaczenia, sprawdź
pt Consulte as traduções disponíveis em
ro Pentru traduceri, consultați
se För översättningar besök
sk Preklady sú dostupné na stránke
sl Za prevode si oglejte
tr Çeviriler için bkz
zh 翻译见

www.struers.com/Library