

# LaboPol-60

Instruction Manual

**Original Instructions**



CE

Doc. no.: 16347025-01\_B\_en  
Date of release: 2022.10.13

---

**Copyright**

The contents of this manual are the property of Struers ApS. Reproduction of any part of this manual without the written permission of Struers ApS is not allowed.

All rights reserved. © Struers ApS 2022.10.13.

---

# Table of Contents

<b>1 About this manual</b> .....	<b>8</b>
<b>2 Safety</b> .....	<b>8</b>
2.1 Intended use .....	8
2.2 LaboPol-60 safety precautions .....	9
2.2.1 Read carefully before use .....	9
2.3 Safety messages .....	10
2.4 Safety messages in this manual .....	11
<b>3 Getting started</b> .....	<b>13</b>
3.1 Device description .....	13
3.2 LaboPol-60 - Front view .....	14
3.2.1 Control panel/Specimen movers .....	15
3.3 LaboPol-60 - Rear view .....	15
3.4 Struers knowledge .....	16
3.5 Accessories and consumables .....	16
<b>4 Transport and storage</b> .....	<b>16</b>
4.1 Transport .....	16
4.2 Long-term storage or shipping .....	17
<b>5 Installation</b> .....	<b>18</b>
5.1 Unpacking .....	18
5.2 Checking the packing list .....	18
5.3 Lifting .....	18
5.4 Location .....	19
5.5 Power supply .....	20
5.5.1 Single-phase supply .....	20
5.5.2 2-phase supply .....	20
5.5.3 Connection to the machine .....	21
5.6 Water supply and water outlet .....	21
5.6.1 Connecting to the water supply .....	21
5.6.2 Connecting to the waste water outlet .....	21
5.7 Recirculation unit .....	22
5.7.1 Connecting the recirculation cooling unit to the water inlet .....	22
5.7.2 Connecting the recirculation cooling unit to the water outlet .....	22
5.7.3 Connecting the communication cable .....	23
5.8 Installing the preparation disc .....	23

---

5.8.1 Preparation disc types .....	23
5.9 Noise .....	23
5.10 Vibration .....	24
<b>6 LaboUI .....</b>	<b>24</b>
6.1 Installation .....	24
6.1.1 Unpacking .....	24
6.1.2 Checking the packing list .....	24
6.1.3 Installation - LaboUI .....	25
6.2 Operating the device .....	25
6.2.1 Control panel functions .....	25
6.2.2 Water tap .....	26
6.2.3 The Spin function .....	27
6.2.4 The splash guard .....	27
6.2.5 Manual preparation .....	27
6.2.6 Starting and stopping the machine .....	28
<b>7 LaboForce-50 .....</b>	<b>29</b>
7.1 Installation .....	30
7.1.1 Unpacking .....	30
7.1.2 Checking the packing list .....	30
7.1.3 Installation - LaboForce-50 .....	30
7.1.4 Adjusting the specimen mover .....	31
7.2 Operating the device .....	33
7.2.1 Control panel functions .....	33
7.2.2 Water tap .....	34
7.2.3 The Spin function .....	34
7.2.4 The splash guard .....	35
7.2.5 Inserting a specimen .....	35
7.2.6 Adjusting the force .....	36
7.2.7 Manual preparation .....	36
7.2.8 Starting and stopping the machine .....	37
7.2.9 Removing the specimens .....	38
7.2.10 Changing the specimen mover plate .....	39
<b>8 LaboForce-100 .....</b>	<b>39</b>
8.1 Installation .....	40
8.1.1 Unpacking .....	40
8.1.2 Checking the packing list .....	40
8.1.3 Installation - LaboForce-100 .....	40
8.1.4 Electrical connection to the machine .....	41
8.1.5 Compressed-air connections .....	41

---

8.1.6	The specimen mover .....	41
8.1.7	The flexible specimen holder .....	45
8.1.8	LaboDoser-100 with LaboForce-100 .....	48
8.1.9	LaboDoser-10 with LaboForce-100 .....	48
8.2	Operating the device .....	48
8.2.1	Control panel functions .....	48
8.2.2	Water tap .....	50
8.2.3	The Spin function .....	50
8.2.4	The splash guard .....	51
8.2.5	The display .....	51
8.2.6	Main menu .....	52
8.2.7	Navigating in the display .....	52
8.2.8	Changing settings and text .....	53
8.2.9	Software settings .....	53
8.2.10	Configuration .....	54
8.2.11	Maintenance menu .....	57
8.3	The preparation process .....	58
8.3.1	Preparation modes .....	58
8.3.2	Starting and stopping the preparation process .....	62
<b>9</b>	<b>LaboForce-Mi</b> .....	<b>63</b>
9.1	Installation .....	64
9.1.1	Unpacking .....	64
9.1.2	Checking the packing list .....	64
9.1.3	Installation - LaboForce-Mi .....	64
9.1.4	The specimen mover .....	65
9.2	Operating the device .....	67
9.2.1	Control panel functions .....	67
9.2.2	Water tap .....	68
9.2.3	The Spin function .....	68
9.2.4	The splash guard .....	69
9.2.5	Inserting a specimen .....	69
9.2.6	Adjusting the force .....	69
9.2.7	Forced rotation of specimens .....	70
9.2.8	Manual preparation .....	70
9.2.9	Starting and stopping the machine .....	71
9.2.10	Removing the specimens .....	72
9.2.11	Changing the specimen mover plate .....	72
<b>10</b>	<b>LaboDoser-10</b> .....	<b>73</b>
10.1	Unpacking .....	74

---

10.2 Checking the packing list .....	74
10.3 Installation .....	74
10.4 Operating LaboDoser-10 .....	75
10.5 Changing lubricant/suspension .....	75
<b>11 LaboDoser-100 .....</b>	<b>76</b>
11.1 Installation .....	76
11.1.1 Unpacking .....	76
11.1.2 Checking the packing list .....	77
11.1.3 Installing LaboDoser-100 .....	77
11.2 Operating LaboDoser-100 .....	78
11.2.1 Changing lubricant/suspension .....	78
11.2.2 Cleaning the tubes .....	79
11.2.3 Changing the pump tubes .....	79
<b>12 Maintenance and service - LaboPol-60 .....</b>	<b>81</b>
12.1 General cleaning .....	81
12.2 Daily .....	82
12.3 Weekly .....	82
12.3.1 LaboForce-100 - the specimen mover head .....	82
12.4 Monthly .....	83
12.4.1 LaboForce-50 - pressure feet .....	83
12.4.2 LaboForce-100 - Emptying the water/oil filter .....	83
12.5 Annually .....	84
12.5.1 Testing safety devices .....	84
12.5.2 Emergency stop .....	84
12.6 Spare parts .....	84
12.7 Service and repair .....	85
12.7.1 Service check - LaboForce-100 .....	85
12.8 Disposal .....	86
<b>13 Troubleshooting - LaboPol-60 .....</b>	<b>86</b>
13.1 Troubleshooting - LaboPol-60 .....	86
13.2 LaboForce-50 .....	87
13.3 LaboForce-100 .....	88
13.3.1 Messages and errors - LaboForce-100 .....	88
13.4 LaboForce-Mi .....	91
<b>14 Technical data .....</b>	<b>92</b>
14.1 Technical data .....	92
14.2 Safety Circuit Categories/Performance Level .....	93
14.3 Noise and vibration levels .....	93
14.4 Technical data - equipment units .....	93

---

14.5 Safety Related Parts of the Control System (SRP/CS) .....	93
14.6 Diagrams .....	94
14.6.1 Diagrams - LaboPol-60 .....	94
14.6.2 Diagrams - equipment units .....	99
14.7 Legal and regulatory information .....	99
<b>15 Pre-installation checklist .....</b>	<b>99</b>
15.1 Installation requirements .....	99
15.2 Packaging specifications .....	100
15.3 Location .....	102
15.4 Dimensions .....	103
15.5 Recommended space .....	105
15.6 Transport and storage .....	106
15.6.1 Transport .....	106
15.6.2 Long-term storage or shipping .....	106
15.7 Unpacking .....	107
15.8 Lifting .....	107
15.9 Power supply .....	108
15.10 Connection to the machine .....	109
15.11 Safety specifications .....	109
15.12 Water supply .....	109
15.13 Compressed air .....	110
15.14 Recirculation cooling unit .....	110
<b>16 Manufacturer .....</b>	<b>111</b>
<b>Declaration of Conformity .....</b>	<b>113</b>

# 1 About this manual

## Instruction Manuals

Struers equipment must only be used in connection with and as described in the Instruction Manual supplied with the equipment.



**Note**

Read the instruction manual carefully before use.



**Note**

If you wish to view specific information in detail, see the online version of this manual.

## 2 Safety

### 2.1 Intended use

The machine is for use in a professional working environment (e.g. a materialographic laboratory).

The equipment is designed to be used only with Struers consumables specifically designed for this purpose and this type of machine.

The machine is for professional manual or semi-automatic materialographic preparation (grinding or polishing) of materials for further materialographic inspection.

The machine must be operated only by skilled/trained personnel.

**Manual preparation**

LaboPol-60 is intended to be used in combination with:

- LaboUI

**Semi-automatic preparation**

LaboPol-60 is intended to be used in combination with:

- LaboForce-50
- LaboForce-100 with or without LaboDoser-100
- LaboForce-Mi



**Do not use the machine for the following** Preparation (grinding or polishing) of materials other than solid materials suitable for materialographic studies.

The machine must not be used for any type of explosive and/or flammable material, or materials which are not stable during machining, heating or pressure.

**Model** LaboPol-60

## 2.2 LaboPol-60 safety precautions



### 2.2.1 Read carefully before use

In combination with: LaboUI, LaboForce-50, LaboForce-100, LaboForce-Mi, LaboDoser-100.

Ignoring this information and mishandling of the equipment can lead to severe bodily injuries and material damage.

#### Specific safety precautions - residual risks

1. The operator must read the Instruction Manual and, where applicable, the Safety Data Sheets for the applied consumables.
2. The machine must be placed on a safe and stable table with an adequate working height. The table must be able to carry at least the weight of the machine and the accessories.
3. Connect the machine to a cold water tap. Make sure that the water connections are leak-proof and that the water outlet is working.
4. Keep clear of rotating parts during operation. When you perform manual grinding or polishing, be careful not to touch the disc. Do not try to collect a specimen from the tray while the disc is rotating.
5. To prevent specimens from detaching from the specimen holder, make sure that the specimen or specimens are clamped securely in the specimen holder.
6. Wear suitable gloves to protect fingers from abrasives and warm/sharp specimens.
7. Protective footwear is recommended when you handle heavy specimen holders.
8. When working at machines with rotating parts, take care to prevent clothes and/or hair from being caught by the rotating parts. Appropriate safety clothing must be used.
9. Prolonged exposure to loud noises may cause permanent damage to a person's hearing. Use hearing protection if the exposure to noise exceeds the levels set by local regulations.
10. Risk of hand to arm vibration during manual preparation. Prolonged exposure to vibration may cause discomfort, joint damage or even neurological damage.
11. The machine must be disconnected from the electrical power supply prior to any service. Wait 5 minutes until residual potential on the capacitors is discharged.
12. The machine must not be used for any type of explosive and/or flammable material, or materials which are not stable during machining, heating or pressure.

### General safety precautions

1. The machine must be installed in compliance with local safety regulations. All functions on the machine and any connected equipment must be in working order.
2. The operator must read the safety precautions and Instruction Manual, as well as relevant sections of the manuals for any connected equipment and accessories.
3. This machine must be operated and maintained only by skilled/trained personnel.
4. The machine must always be used with the splash guards in place.
5. Make sure that the actual electrical power supply voltage corresponds to the voltage stated on the type plate of the machine. The machine must be earthed (grounded). Always follow local regulations. Always switch off the electrical power supply and remove the plug or power cable before dismantling the machine or installing additional components.
6. Struers recommends that the main water supply is shut off or disconnected if the machine is to be left unattended.
7. Consumables: only use consumables specifically developed for use with this type of materialographic machine. Alcohol-based consumables: follow the current safety rules for handling, mixing, filling, emptying and disposing of alcohol-based liquids.
8. Keep your hands clear of the specimen holder (if applicable) or specimen mover plate when lowering the specimen mover unit, if installed.
9. If you observe malfunctions or hear unusual noises, switch off the machine and call technical service.
10. Do not switch the machine on and off more than once every five minutes. Damage to the electrical components could occur.
11. In case of fire, alert bystanders and the fire brigade. Disconnect the electrical power supply. Use a powder fire extinguisher. Do not use water.
12. Struers equipment must only be used in connection with and as described in the Instruction Manual supplied with the equipment.
13. The equipment is designed to be used only with Struers consumables specifically designed for this purpose and this type of machine.
14. If the equipment is subjected to misuse, incorrect installation, alteration, neglect, accident or incorrect repair, Struers will accept no responsibility for damage to the user or the equipment.
15. Dismantling of any part of the equipment, during service or repair, should always be performed by a qualified technician (electromechanical, electronic, mechanical, pneumatic, etc.).

## 2.3 Safety messages

Struers uses the following signs to indicate potential hazards.



#### **ELECTRICAL HAZARD**

This sign indicates an electrical hazard which, if not avoided, will result in death or serious injury.

**DANGER**

This sign indicates a hazard with a high level of risk which, if not avoided, will result in death or serious injury.

**WARNING**

This sign indicates a hazard with a medium level of risk which, if not avoided, could result in death or serious injury.

**CAUTION**

This sign indicates a hazard with a low level of risk which, if not avoided, could result in minor or moderate injury.

**CRUSHING HAZARD**

This sign indicates a crushing hazard which, if not avoided, could result in minor, moderate or serious injury.

**HEAT HAZARD**

This sign indicates a heat hazard which, if not avoided, can result in minor, moderate or serious injury.

**General messages****Note**

This sign indicates that there is a risk of damage to property, or a need to proceed with special care.

**Hint**

This sign indicates that additional information and hints are available.

## 2.4 Safety messages in this manual

**WARNING**

Struers equipment must only be used in connection with and as described in the Instruction Manual supplied with the equipment.

**CRUSHING HAZARD**

Take care of your fingers when handling the machine.  
Wear safety shoes when handling heavy machinery.

**WARNING**

Switch off the machine, disconnect the electrical power cable and wait 5 minutes before you dismantle the machine or install additional components.

**ELECTRICAL HAZARD**

Switch off the electrical power supply before installing electrical equipment.  
The machine must be earthed (grounded).  
Make sure that the actual electrical power supply voltage corresponds to the  
Incorrect voltage can damage the electrical circuit.



**ELECTRICAL HAZARD**

The pump of the recirculation cooling unit must be earthed (grounded).  
Make sure that the electrical power supply voltage corresponds to the voltage stated on the type plate of the pump.  
Incorrect voltage can damage the electrical circuit.



**CAUTION**

Prolonged exposure to loud noises may cause permanent damage to a person's hearing.  
Use hearing protection if the exposure to noise exceeds the levels set by local regulations.



**CAUTION**

Risk of hand to arm vibration during manual preparation.  
Prolonged exposure to vibration may cause discomfort, joint damage or even neurological damage.



**CAUTION**

Keep clear of rotating parts during operation.



**CAUTION**

When working at machines with rotating parts, take care to prevent clothes and/or hair from being caught by the rotating parts.



**CAUTION**

To prevent specimens from detaching from the specimen holder, make sure that the specimen or specimens are clamped securely in the specimen holder.



**CAUTION**

For manual preparation use the switch on the side of the specimen mover head to disable rotation of LaboForce-50.



**CAUTION**

For manual preparation use the switch on the side of the specimen mover head to disable rotation of LaboForce-Mi.



**CAUTION**

Wear suitable gloves to protect fingers from abrasives and warm/sharp specimens.



**CAUTION**

When you perform manual grinding or polishing, be careful not to touch the disc.



**CAUTION**

Do not try to collect a specimen from the tray while the disc is rotating.

**CAUTION**

When the disc is rotating, make sure your hands are kept completely clear of its periphery and out of the splash bowl.

**WARNING**

Do not use the machine with defective safety devices.  
Contact Struers Service.

**WARNING**

Before you release the emergency stop, investigate the reason for activating the emergency stop and take any necessary corrective action.

**CAUTION**

Protective footwear is recommended when you handle heavy specimen holders.

**CRUSHING HAZARD**

Keep your hands clear of the specimen holder or specimen mover plate when lowering the specimen mover.

**WARNING**

Safety critical components must be replaced after a maximum lifetime of 20 years.  
Contact Struers Service.

## 3 Getting started

### 3.1 Device description

LaboPol-60 is a dual disc machine for materialographic preparation (grinding/polishing) using preparation discs of 230, 250 or 300 mm in diameter.

LaboPol-60 is for manual preparation when used with LaboUI. The right disc is always intended for manual preparation.

LaboPol-60 is for semi-automatic preparation when used with LaboForce-50, LaboForce-100 or LaboForce-Mi. The specimen mover is always installed on the left side of the machine.

The operator selects the grinding/polishing surface and the cooling fluid/abrasive suspension to be applied.

Cooling water is applied when the operator opens the water tap. Other fluids are applied manually or by a separate dosing unit.

With LaboUI the operator holds the specimens during the preparation.

With LaboForce-50, LaboForce-100 and LaboForce-Mi the operator places the specimens in a device, the specimen mover plate or the specimen holder.

With LaboUI, LaboForce-50 and LaboForce-Mi the operator sets the rotation speed of the preparation disc before starting the process.

With LaboForce-100 the operator sets the process parameters before starting the process. The machine must always be used with the splash guards in place.

The splash guard for manual preparation is supplied with the machine. (For the 300 mm diameter disc)

The splash guard for other types of preparation must be ordered separately.

The operator starts the machine by pressing the **Start** button on the control panel. Both discs start rotating.

With LaboUI and LaboForce-50 and LaboForce-Mi the operator stops the machine by pressing stop on the control panel. Both discs stop.

With LaboForce-100 the machine stops automatically when the process is completed. Both discs stop.

The operator cleans the specimens before the next preparation step or inspection.

We recommend that an exhaust system is applied when alcohol-based suspension or lubricants are used.

If the emergency stop is activated, the power to all moving parts is cut.

### 3.2 LaboPol-60 - Front view

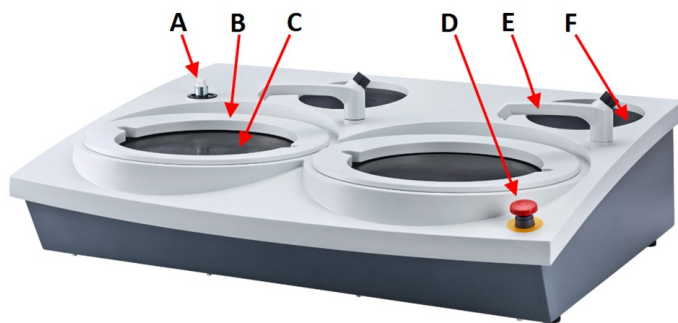

- A** Connection for control panel/specimen mover
- B** Splash guard for manual preparation (both discs)
- C** Preparation disc location (both discs)
- D** Emergency stop
- E** Water tap
- F** Storage pad



#### Emergency stop

If LaboForce-50, LaboForce-100, LaboDoser-100, or LaboForce-Mi is mounted on the machine, activating the emergency stop on the machine will also stop LaboForce-50, LaboForce-100, LaboDoser-100, or LaboForce-Mi.



#### Note

Do not use the emergency stop for operational stop of the machine during normal operation. Before you release the emergency stop, investigate the reason for activating the emergency stop and take any necessary corrective action.

- To activate the emergency stop, press the red emergency stop button.
- To release the emergency stop, turn the red emergency stop button clockwise.

### 3.2.1 Control panel/Specimen movers

The machine can be mounted with one of the following units. See the specific sections for installation instructions.



#### LaboUI

- See [Control panel functions](#) ► 25.



#### LaboForce-50

- See [Control panel functions](#) ► 33.



#### LaboForce-100

- See [Control panel functions](#) ► 48.



#### LaboForce-Mi

- See [Control panel functions](#) ► 67.

### 3.3 LaboPol-60 - Rear view

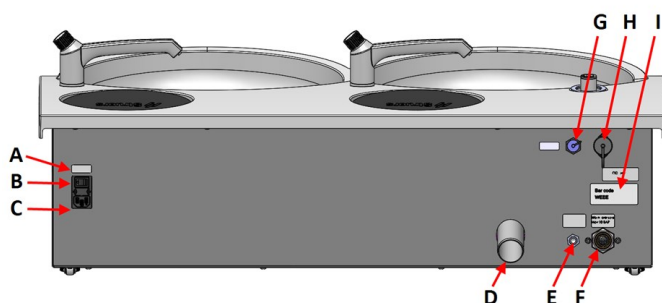

- A** Main switch
- B** Fuses
- C** Electrical power socket
- D** Waste water outlet
- E** Water inlet from recirculation cooling unit
- F** Water inlet from main water supply
- G** Recirculation unit socket
- H** LaboForce-100 socket
- I** Type plate

### 3.4 Struers knowledge

Mechanical preparation is the most common method of preparing metallographic specimens for microscopic examination.

The specific requirement of the prepared surface is determined by the particular type of analysis or examination.

Specimens can be prepared to the perfect finish, the true structure, or the preparation can be stopped when the surface is acceptable for a specific examination.



**Hint**

For further information, see the section on Grinding and Polishing on the Struers website.

### 3.5 Accessories and consumables

**Accessories**

For information about the available range, see:

- [The LaboSystem brochure](https://www.struers.com/Products/Grinding-and-Polishing/Grinding-and-polishing-equipment/LaboSystem) (https://www.struers.com/Products/Grinding-and-Polishing/Grinding-and-polishing-equipment/LaboSystem)

**Consumables**

The use of Struers consumables is recommended.

Other products may contain aggressive solvents, which dissolve e.g. rubber seals. The warranty may not cover damaged machine parts (e.g. seals and tubes), where the damage can be directly related to the use of consumables not supplied by Struers.

For information about the available range, see:

- [The Struers Consumables Catalogue](http://www.struers.com/Library) (http://www.struers.com/Library)

## 4 Transport and storage

If, at any time after the installation, you have to move the unit or place it in storage, there is a number of guidelines we recommend that you follow.

- Package the unit securely before transportation.  
Insufficient packaging could cause damage to the unit and will void the warranty. Contact Struers Service.
- Struers recommends that all original packaging and fittings are kept for future use.

### 4.1 Transport

- Disconnect the unit from the electrical power supply.



- Disconnect the water inlet and the water outlet.
- Disconnect the cooling system, if installed. See the instructions for the specific unit.
- Remove the splash guard, the preparation disc and the bowl liner.
- Lift the machine by gripping the base of the machine from beneath, from both the left side and the right side.



- Alternatively, use a crane and two lifting straps to lift the machine.
- Position the straps under the machine, so that they are on the outer side of the feet.

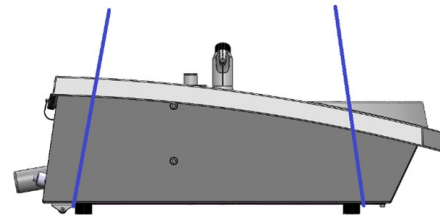

- Lift the machine onto a stable surface.

## 4.2 Long-term storage or shipping



### Note

Struers recommends that all original packaging and fittings are kept for future use.

- Clean the machine and all accessories thoroughly.
- Disconnect the unit from the electrical power supply.
- Disconnect the water inlet and the water outlet.
- Disconnect the cooling system, if installed. See the instructions for the specific unit.
- Remove the splash guard, the preparation disc and the bowl liner.
- Remove the control panel or specimen mover.
- Remove any accessories.
- Lift the machine by gripping the base of the machine from beneath, from both the left side and the right side.
- Place the machine and accessories in their original packaging.
- Secure the boxes on a pallet with straps.

### At the new location

At the new location, make sure that the facilities required are in place.

# 5 Installation

## 5.1 Unpacking



### Note

Struers recommends that all original packaging and fittings are kept for future use.

1. Cut the packing tape on the top of the box.
2. Remove the loose parts.
3. Remove the unit from the box.

## 5.2 Checking the packing list

Optional accessories may be included in the packing box.

The packing box contains the following items:

Pcs.	Description
1	LaboPol-60
2	Electrical power supply cables
2	Disposable bowl liner, clear plastic
2	Splash guard for manual preparation
1	Water inlet hose. Diameter: 19 mm/¾". Length: 2 m/6.6'
1	Filter gasket
1	Reduction ring with gasket, ¾" to ½"
1	Water outlet hose. Diameter: 40 mm/1.6". Length: 1.5 m/4.9'
1	Elbow pipe for water outlet
1	Hose clamp
1	Allen key with cross handle, 6x150 mm/0.23x6"
2	Caps for use after mounting control panel
1	Yellow cap for use with a Recirculation Cooling Unit
1	Instruction Manual set

## 5.3 Lifting



### CRUSHING HAZARD

Take care of your fingers when handling the machine.  
Wear safety shoes when handling heavy machinery.

**Note**

Do not lift the machine by the light gray top part or by the water tap.  
Always lift the machine from beneath.

**Weight****LaboPol-60**

50 kg (110 lbs)

- Lift the machine by gripping the base of the machine from beneath, from both the left side and the right side.

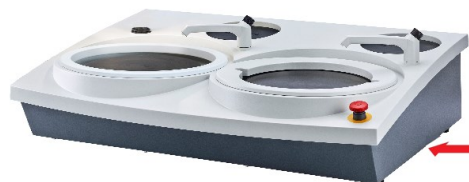

- Alternatively, use a crane and two lifting straps to lift the machine.
- Position the straps under the machine, so that they are on the outer side of the feet.

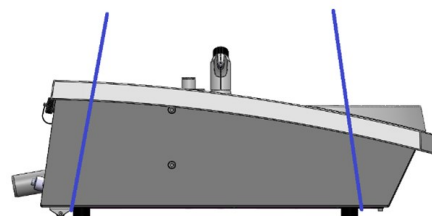

- Lift the front of the machine and carefully move it onto the table using the rollers at the rear end of the machine.
- The machine must rest securely with all 4 feet on the table.

## 5.4 Location

**CRUSHING HAZARD**

Take care of your fingers when handling the machine.  
Wear safety shoes when handling heavy machinery.

- The machine must be placed close to the electrical power supply, main water supply and waste water drain.
- To facilitate easy access for service technicians, allow sufficient space around the machine.
- Place the machine on a rigid, stable workbench with a horizontal surface and an adequate height.
- To move the machine, lift the front of the machine and use the rollers to carefully move it into place.
- The machine must rest securely with all 4 feet on the table.
- To level the machine, turn the adjustable rubber feet.

## 5.5 Power supply



### WARNING

Switch off the machine, disconnect the electrical power cable and wait 5 minutes before you dismantle the machine or install additional components.



### ELECTRICAL HAZARD

Switch off the electrical power supply before installing electrical equipment. The machine must be earthed (grounded). Make sure that the actual electrical power supply voltage corresponds to the voltage stated on the type plate of the machine. Incorrect voltage can damage the electrical circuit.



### Note

An autotransformer is required in countries with a 110 V electrical power supply.

### Power socket

The electrical power supply socket must be easy to access. The electrical power supply socket must be located at a height ranging from 0.6 m to 1.9 m (2½" to 6") above floor level. Not higher than 1.7 m (5' 6") is recommended.



### Note

The equipment is shipped with 2 types of electrical power cables. If the plug supplied on these cables is not approved in your country, the plug must be replaced with an approved plug.

### 5.5.1 Single-phase supply

#### Single-phase supply

The 2-pin plug (European Schuko) is for use on single-phase electrical power connections.



The leads must be connected as follows:

Yellow/Green	Earth (ground)
Brown	Line (live)
Blue	Neutral

### 5.5.2 2-phase supply

The 3-pin plug (North American NEMA) is for use on 2-phase electrical power connections.



The leads must be connected as follows:

Green	Earth (ground)
Black	Line (live)
White	Line (live)

### 5.5.3 Connection to the machine

- Connect the electrical power cable to the machine (C14 IEC 320 connector).
- Connect the cable to the electrical power supply.



## 5.6 Water supply and water outlet

Water for wet grinding is supplied from the main water supply or from a recirculation cooling unit (optional).

See [Recirculation unit](#) ► 22.

### 5.6.1 Connecting to the water supply



#### Note

The cold-water supply must have a head pressure in the range: 1 to 9.9 bar (14.5 to 143 psi)



#### Hint

New water pipe installations:

Leave the water to run for a few minutes to flush any debris from the pipe before connecting the machine to the water supply.

#### Connecting the water inlet hose

Connect the 90°-angle end of the water inlet hose to the water inlet on the back of the machine:

1. Insert the filter gasket in the coupling nut with the flat side against the water inlet hose.
2. Tighten the coupling nut firmly.

Connect the straight end of the water inlet hose to the water supply tap for cold water:

1. If needed, connect the reduction piece with gasket to the water supply tap.
2. Tighten the coupling nut firmly.

### 5.6.2 Connecting to the waste water outlet

1. Connect the elbow pipe to the waste water outlet pipe.
2. Connect the waste water outlet hose to the elbow pipe. If needed, lubricate with grease or soap to make it easier to insert the pipe in the hose. Use a hose clamp to fasten the hose to the pipe.
3. Lead the other end of the waste water hose to the waste water drain. If needed, shorten the hose.

**Note**  
 Make sure that the hose slopes downward towards the waste water drain throughout its entire length.  
 Make sure that there are no sharp bends in the waste water hose.

## 5.7 Recirculation unit

To ensure optimal cooling, mount a recirculation unit on the machine.

**Note**  
 Before you connect the recirculation unit to the machine, you must prepare it for use.  
 See the Instruction Manual for this unit.

**ELECTRICAL HAZARD**  
 The pump of the recirculation cooling unit must be earthed (grounded).  
 Make sure that the electrical power supply voltage corresponds to the voltage stated on the type plate of the pump.  
 Incorrect voltage can damage the electrical circuit.

### 5.7.1 Connecting the recirculation cooling unit to the water inlet

To connect the recirculation cooling unit follow these steps:

1. Mount the yellow cap (supplied) on the water inlet for the main water supply.
2. Remove the quick coupling from one end of the hose delivered with the pump.
3. Slide the hose clamp onto the hose and connect to the water inlet for recirculation water on the back of the machine. Tighten the hose clamp.
4. Connect the quick coupling at the other end of the inlet hose directly to the pump outlet of the cooling unit.

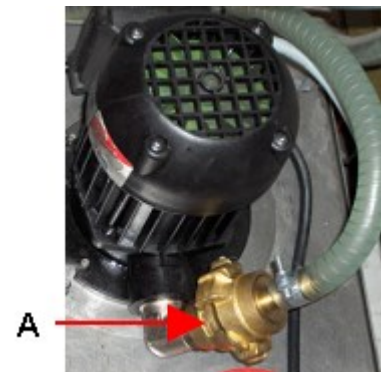

A Pump outlet

### 5.7.2 Connecting the recirculation cooling unit to the water outlet

1. Connect the water outlet hose to the water outlet pipe. Use a hose clamp to secure the hose.
2. Lead the other end of the hose into the mounting hole in the bracket on top of the static filter unit.
3. Make sure that the hose slopes downward towards the waste water drain throughout its entire length. If needed, shorten the hose.

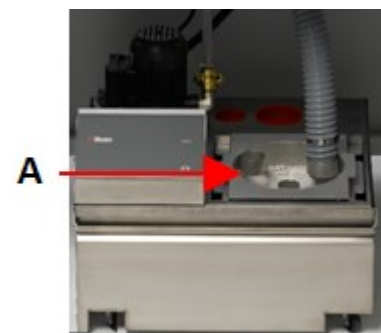

A Static filter unit

### 5.7.3 Connecting the communication cable

- Connect the communication cable from the control box of the recirculation cooling unit to the socket on the back of the machine.

## 5.8 Installing the preparation disc

LaboPol-60 has two preparation discs. The following instructions apply to both discs.



#### Note

Make sure that the cavity on the underside of the preparation disc and the cone on the machine are clean.

Make sure that the bowl liner is clean and that the drain is positioned correctly.

#### Procedure

1. Place the preparation disc carefully on the driving pin.
2. Rotate it slowly until it is safely engaged.

### 5.8.1 Preparation disc types

The machine can be used with the following disc types:

Preparation disc types	Preparation surface
MD-Disc	For MD consumable.
Wet grinding disc	For SiC Paper.
Aluminum disc	For adhesive-backed consumable.

## 5.9 Noise

For information on the sound pressure level value, see this section: [Technical data ▶ 92](#)



#### CAUTION

Prolonged exposure to loud noises may cause permanent damage to a person's hearing.

Use hearing protection if the exposure to noise exceeds the levels set by local regulations.

#### Handling noise during operation

Different materials have different noise characteristics.

#### Manual preparation

To lower the noise, try to decrease the force with which the specimen is pressed against the preparation surface. The processing time may increase.

#### Semi-automatic preparation

To lower the noise, decrease the rotational speed and/or the force with which the specimens are pressed against the preparation surface. The processing time may increase.

## 5.10 Vibration

For information on the total vibration exposure to hand and arm, see this section: [Technical data](#) ►92.



### CAUTION

Risk of hand to arm vibration during manual preparation. Prolonged exposure to vibration may cause discomfort, joint damage or even neurological damage.

### Handling vibration during operation

Manual preparation may cause vibrations in hand and arm. To lower the vibration, decrease the pressure or use a vibration-reducing glove.

# 6 LaboUI

## Front view



- A Control panel
- B Disc speed control
- C Control panel column

## 6.1 Installation

### 6.1.1 Unpacking



#### Note

Struers recommends that all original packaging and fittings are kept for future use.

1. Cut the packing tape on the top of the box.
2. Remove the loose parts.
3. Remove the unit from the box.

### 6.1.2 Checking the packing list

Optional accessories may be included in the packing box.

The packing box contains the following items:



Pcs.	Description
1	LaboUI
1	Instruction Manual set

### 6.1.3 Installation - LaboUI



#### Note

This device must be mounted securely on the machine.

#### Procedure

Install the control panel in the connection hole of the machine.

1. Remove the plastic disc protecting the communication cable.
2. Connect the communication cable on the column to the connection port on the machine.
3. Guide the column down into the connection hole.

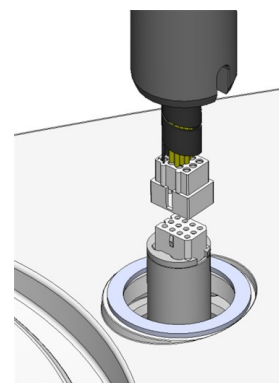

4. Slide the black V-ring down the column until it covers the connection hole.
5. Use the Allen key to tighten the two fastening screws. Do not tighten the screws completely.
6. Cover the holes with the two cover caps.  
Allen key and cover caps are supplied with LaboPol.

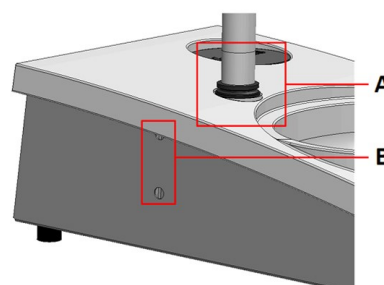

- A** V-ring  
**B** Fastening screws

## 6.2 Operating the device

### 6.2.1 Control panel functions





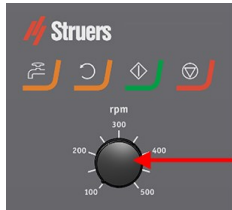

#### CAUTION

Keep clear of rotating parts during operation.

 **CAUTION**  
When working at machines with rotating parts, take care to prevent clothes and/or hair from being caught by the rotating parts.



**A** Disc speed control

Button	Function
	<b>Disc rotation</b> <ul style="list-style-type: none"> <li>Starts rotation of the disc (<b>Spin</b> function).</li> </ul>
	<b>Water</b> Manual override <ul style="list-style-type: none"> <li>Press the button to apply water. Water is applied when no process is running.</li> <li>Press the button again to stop applying water.</li> </ul>
	<b>Start</b> <ul style="list-style-type: none"> <li>Starts the preparation process.</li> </ul>
	<b>Stop</b> <ul style="list-style-type: none"> <li>Stops the preparation process.</li> </ul>

### 6.2.2 Water tap

#### Applying water automatically

Water is applied when a process is running.

- During grinding, open the nozzle on the water tap to apply water.
- During polishing, close the nozzle on the water tap.

 **Note**  
Close the water tap before you start a polishing process.

For optimal results and to avoid splashing, position the water tap between the center and the left edge of the polishing disc.

#### Applying water manually

- To start applying water, press the **Water** button and open the water tap.
- To stop applying water, press the **Water** button or close the water tap.



### 6.2.3 The Spin function

Only use the spin function to rotate the preparation disc at high speed

- to remove water from the surface of the disc.
  - to remove water from an MD-Disc or a SiC Foil/SiC Paper before you remove it,
  - to dry an MD-Disc or an MD-Chem cloth
- To start the spin function, press and hold the **Disc rotation** button.
  - To stop the spin function, release the **Disc rotation** button.



### 6.2.4 The splash guard

#### Manual preparation

- The splash guard for manual preparation is supplied with the machine. (For the 300 mm diameter disc)

#### Wet grinding (for plain-back SiC Paper)

- Use the splash guard for the Wet Grinding Disc.

### 6.2.5 Manual preparation

When you perform manual preparation, you hold the specimen in your hand and press it firmly onto and across the preparation surface.

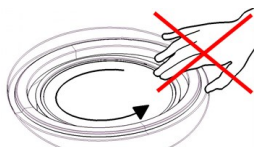

#### CAUTION

Wear suitable gloves to protect fingers from abrasives and warm/sharp specimens.



#### CAUTION

When you perform manual grinding or polishing, be careful not to touch the disc.



#### CAUTION

Do not try to collect a specimen from the tray while the disc is rotating.



#### CAUTION

When the disc is rotating, make sure your hands are kept completely clear of its periphery and out of the splash bowl.

## 6.2.6 Starting and stopping the machine

### Starting the machine



**WARNING**

Do not use the machine with defective safety devices.  
Contact Struers Service.



**CAUTION**

When working at machines with rotating parts, take care to prevent clothes and/or hair from being caught by the rotating parts.



**CAUTION**

Keep clear of rotating parts during operation.



**Note**

We recommend that an exhaust system is applied when alcohol-based suspension or lubricants are used.

1. Set the speed control to the desired disc speed.
2. Press the **Start** button. The machine starts operating.
3. If needed, adjust the disc speed.



### Stopping the machine

- Press the **Stop** button.



### Emergency stop



**Note**

Activating the emergency stop on the machine will stop all movable parts.



**Note**

Do not use the emergency stop for operational stop of the machine during normal operation.

1. Press the emergency stop button to activate an emergency stop.

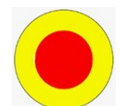

**WARNING**

Before you release the emergency stop, investigate the reason for activating the emergency stop and take any necessary corrective action.

- Turn the emergency stop button to release the emergency stop.

## 7 LaboForce-50

### Front view

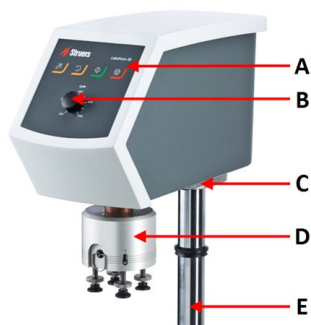

- A Control panel
- B Disc speed control
- C LED light (not shown)
- D Specimen mover head
- E Control panel column

### Rear view

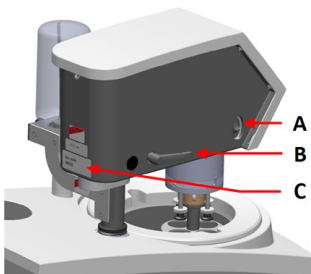

- A Rotation switch (Specimen mover head)
- B Locking handle
- C Type plate

### The specimen mover

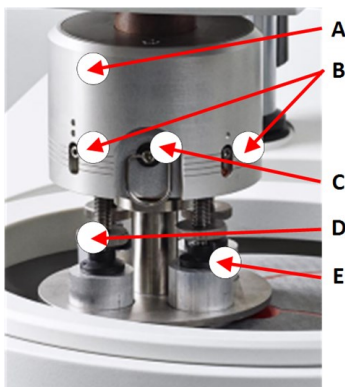

- A Housing
- B Force indicators
- C Quick release ring
- D Force adjustment screw
- E Pressure feet

## 7.1 Installation

### 7.1.1 Unpacking



**Note**  
Struers recommends that all original packaging and fittings are kept for future use.

1. Cut the packing tape on the top of the box.
2. Remove the loose parts.
3. Remove the unit from the box.

### 7.1.2 Checking the packing list

Optional accessories may be included in the packing box.

The packing box contains the following items:

Pcs.	Description
1	LaboForce-50
1	Spacer and 2 M4 screws for mounting on LaboPol-30 and LaboPol-60
1	Spacing disc
1	Allen key for mounting the specimen mover plate
1	Instruction Manual set

### 7.1.3 Installation - LaboForce-50



**Note**  
This device must be mounted securely on the machine.



**Note**  
Do not use the speed control knob on the control panel to move the specimen mover.

#### Procedure

Install the specimen mover in the connection hole of the machine.

1. Remove the plastic disc protecting the communication cable.
2. Connect the communication cable on the column to the connection port on the machine.

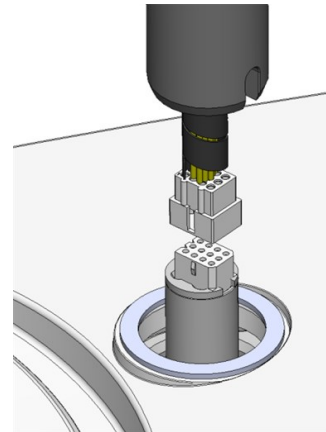

3. Use the M4 screws to mount the spacer on the bottom of the column.
4. Guide the column down into the connection hole.
5. Turn the column until the spacer sits securely in the connection hole.

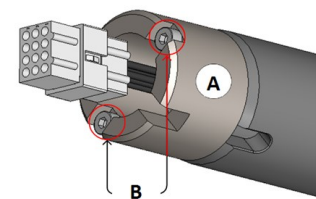

- A** Spacer  
**B** M4 screws

6. Slide the black V-ring down the column until it covers the connection hole.
7. Use the Allen key to tighten the two fastening screws. Do not tighten the screws completely.

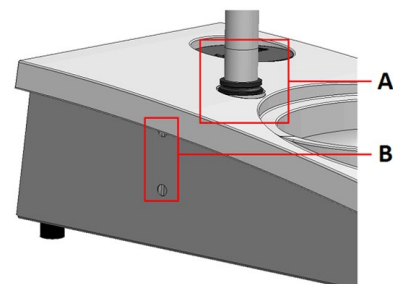

- A** V-ring  
**B** Fastening screws

#### 7.1.4 Adjusting the specimen mover

##### Inserting a specimen mover plate

Before you adjust the specimen mover, you must insert a specimen mover plate.

For approved specimen mover plates, see:

- [The LaboSystem brochure](https://www.struers.com/Products/Grinding-and-Polishing/Grinding-and-polishing-equipment/LaboSystem) (<https://www.struers.com/Products/Grinding-and-Polishing/Grinding-and-polishing-equipment/LaboSystem>)

1. Use the locking handle on the left side to unlock the specimen mover and let it move into upright position.
2. Pull the quick-release ring and lift the housing.
3. Insert a specimen mover plate and rotate it until the two pins are aligned with the holes in the specimen mover.
4. Push the specimen mover plate upwards and use the Allen key to tighten the screw to secure it in position. See **A**.
5. Make sure that the specimen mover plate is securely mounted.
6. Lower the housing back into position.

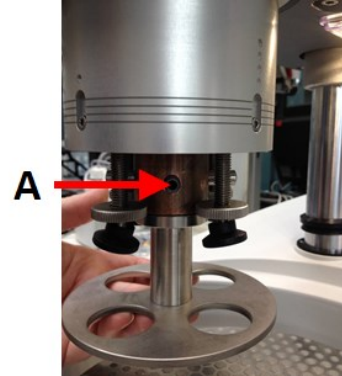

**A** Screw

**Adjusting the height of the specimen mover plate**

1. Use the locking handle on the left side to unlock the specimen mover and let it move into upright position.
2. Select the ‘thickest’ preparation surface to be used and place it on the preparation disc. Usually, this will be SiC Foil on an MD-Gekko disc, or SiC Paper on an MD-Fuga disc, or an MD-Alto.
3. Place the supplied spacing disc on the preparation surface.
4. Support the specimen mover head and loosen the 2 fastening screws that hold the column.
5. Lift and support the specimen mover.
6. Press the specimen mover head down as far as possible.
7. Use the locking handle to lock the specimen mover head in operating position.
8. Lower the column until the specimen mover plate rests on the spacing disc.
9. Adjust the horizontal position of the specimen mover plate.

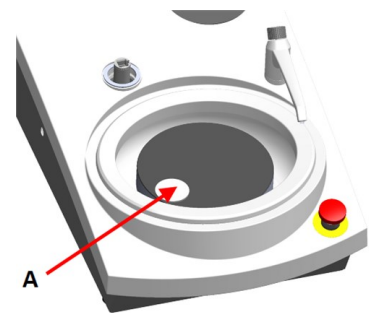

**A** Spacing disc



## Adjusting the horizontal position of the specimen mover plate

### MD-Disc

1. Moves the specimen mover head to the right.
2. Place the specimen mover plate in a position that allows the specimen to run 3 – 4 mm over the edge of the preparation disc.

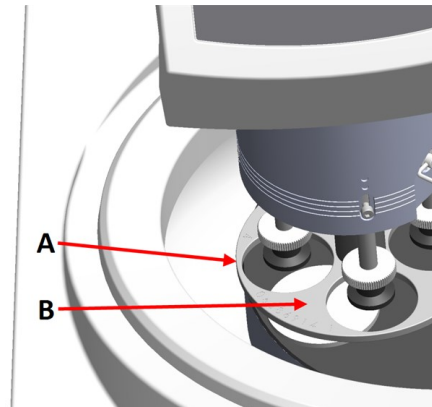

A Disc edge  
B Specimen mover plate

### Wet Grinding Disc

1. Moves the specimen mover head to the right.
2. Place the specimen mover plate in a position 2 – 3 mm from the metal ring.

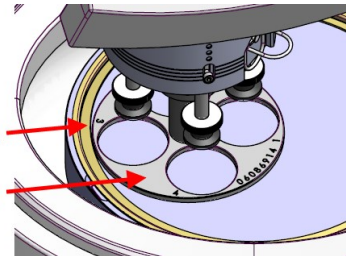

A Metal ring  
B Specimen mover plate

### Completing the adjustment

1. Tighten the 2 fastening screws firmly. The specimen mover will now remain in position.
2. Cover the holes with the two caps.  
Allen key and cover caps are included in the package.

## 7.2 Operating the device

### 7.2.1 Control panel functions



#### CAUTION

Keep clear of rotating parts during operation.



#### CAUTION

When working at machines with rotating parts, take care to prevent clothes and/or hair from being caught by the rotating parts.

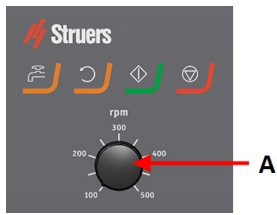

A Disc speed control

Button	Function
	<b>Disc rotation</b> <ul style="list-style-type: none"> <li>Starts rotation of the disc (<b>Spin</b> function).</li> </ul>
	<b>Water</b> Manual override <ul style="list-style-type: none"> <li>Press the button to apply water. Water is applied when no process is running.</li> <li>Press the button again to stop applying water.</li> </ul>
	<b>Start</b> <ul style="list-style-type: none"> <li>Starts the preparation process.</li> </ul>
	<b>Stop</b> <ul style="list-style-type: none"> <li>Stops the preparation process.</li> </ul>

### 7.2.2 Water tap

#### Applying water automatically

Water is applied when a process is running.

- During grinding, open the nozzle on the water tap to apply water.
- During polishing, close the nozzle on the water tap.



#### Note

Close the water tap before you start a polishing process.

For optimal results and to avoid splashing, position the water tap between the center and the left edge of the polishing disc.

#### Applying water manually

- To start applying water, press the **Water** button and open the water tap.
- To stop applying water, press the **Water** button or close the water tap.



### 7.2.3 The Spin function

Only use the spin function to rotate the preparation disc at high speed

- to remove water from the surface of the disc.
- to remove water from an MD-Disc or a SiC Foil/SiC Paper before you remove it,

- to dry an MD-Disc or an MD-Chem cloth
- To start the spin function, press and hold the **Disc rotation** button.
- To stop the spin function, release the **Disc rotation** button.



## 7.2.4 The splash guard

### Manual preparation

- The splash guard for manual preparation is supplied with the machine. (For the 300 mm diameter disc)

### Semi-automatic preparation

- Use the splash guard for semi-automatic preparation.

### Wet grinding (for plain-back SiC Paper)

- Use the splash guard for the Wet Grinding Disc.

## 7.2.5 Inserting a specimen

1. Lift the pressure feet on the force adjustment screw to make room for the specimen.
2. Place the specimen in one of the holes of the specimen mover plate and lower the pressure feet.

Each position is marked for easy identification of the individual specimen.

### For taller specimens

1. Pull the quick-release ring and lift the housing.
2. Lift the pressure feet up as far as possible.
3. Lower the housing back into position.

- A** Force indicator
- B** Force adjustment screw
- C** Pressure foot

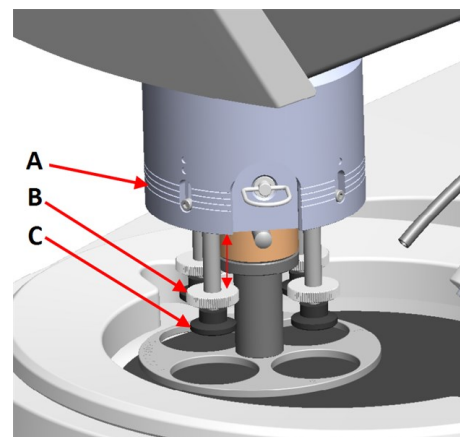

### 7.2.6 Adjusting the force



**Hint**  
Do not use maximum force at the same time as maximum speed.

- To adjust the force, turn the force adjustment screw.  
The indications on the housing correspond to the actual force in Newton.

- A** Force indicator
- B** Force adjustment screw
- C** Pressure foot

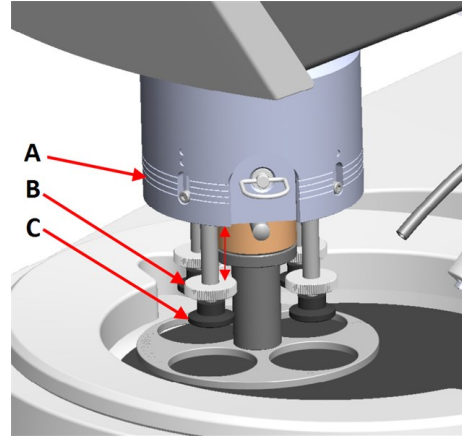

Indication	Force
(0)	0 - 5 N
1	10 N
2	20 N
3	30 N

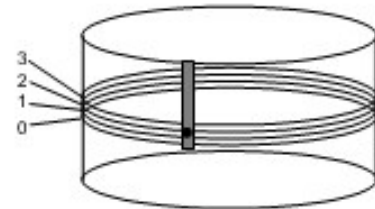

### 7.2.7 Manual preparation

If you cannot prepare a specimen by using a standard specimen mover plate or specimen holder, you can prepare it manually.

When you perform manual preparation, you hold the specimen in your hand and press it firmly onto and across the preparation surface.

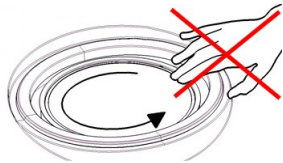
**CAUTION**

For manual preparation use the switch on the side of the specimen mover head to disable rotation of LaboForce-50.

**CAUTION**

Wear suitable gloves to protect fingers from abrasives and warm/sharp specimens.

**CAUTION**

When you perform manual grinding or polishing, be careful not to touch the disc.

**CAUTION**

Do not try to collect a specimen from the tray while the disc is rotating.

**CAUTION**

When the disc is rotating, make sure your hands are kept completely clear of its periphery and out of the splash bowl.

### Rotation of the specimen mover head

- For manual preparation you can use the switch on the side of the specimen mover head to disable rotation of LaboForce-50.

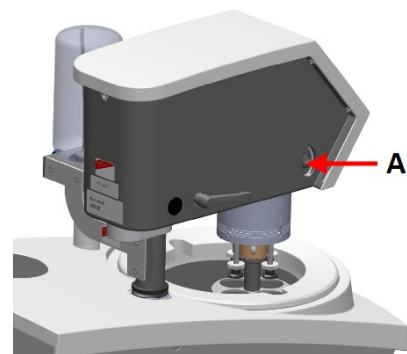

A Switch

## 7.2.8 Starting and stopping the machine

### Starting the machine

**WARNING**

Do not use the machine with defective safety devices.  
Contact Struers Service.



**CAUTION**

When working at machines with rotating parts, take care to prevent clothes and/or hair from being caught by the rotating parts.



**CAUTION**

Keep clear of rotating parts during operation.



**Note**

We recommend that an exhaust system is applied when alcohol-based suspension or lubricants are used.

1. Set the speed control to the desired disc speed.
2. Press the **Start** button. The machine starts operating.
3. If needed, adjust the disc speed.



**Stopping the machine**

- Press the **Stop** button.



**Emergency stop**



**Note**

Activating the emergency stop on the machine will stop all movable parts.



**Note**

Do not use the emergency stop for operational stop of the machine during normal operation.

1. Press the emergency stop button to activate an emergency stop.



**WARNING**

Before you release the emergency stop, investigate the reason for activating the emergency stop and take any necessary corrective action.

2. Turn the emergency stop button to release the emergency stop.

**7.2.9 Removing the specimens**

1. To release the specimens, pull the quick-release ring.
2. When you have removed the specimens, lower the spring housing back into position.

### 7.2.10 Changing the specimen mover plate

If you wish to prepare specimens of another diameter, use a different specimen mover plate. The specimens must fit the holes in the specimen mover plate.

1. Use the locking handle on the left side to unlock the specimen mover and let it move into upright position.
2. Pull the quick-release ring and lift the housing.
3. Loosen the screw and remove the specimen mover plate.
4. Insert a specimen mover plate and rotate it until the two pins are aligned with the holes in the specimen mover.
5. Push the specimen mover plate upwards and use the Allen key to tighten the screw to secure it in position.
6. Make sure that the specimen mover plate is securely mounted.
7. Make sure that the specimen mover plate is in a horizontal position.
8. If needed, adjust the position of the specimen mover plate. See [Adjusting the horizontal position of the specimen mover plate](#) ► 33
9. The specimen mover plate must be positioned to allow the specimen to run 3 – 4 mm over the edge of the preparation disc.
10. Lower the housing back into position.

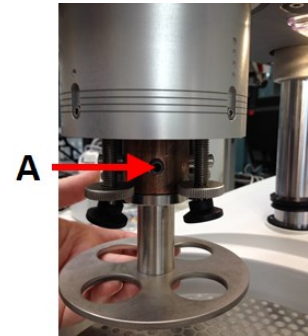

A Screw

## 8 LaboForce-100

Front view



- A Control panel
- B Turn/push knob
- C LED lights (not shown)
- D Specimen mover head
- E Control panel column

## 8.1 Installation

### 8.1.1 Unpacking



**Note**  
Struers recommends that all original packaging and fittings are kept for future use.

1. Cut the packing tape on the top of the box.
2. Remove the loose parts.
3. Remove the unit from the box.

### 8.1.2 Checking the packing list

Optional accessories may be included in the packing box.

The packing box contains the following items:

Pcs.	Description
1	LaboForce-100
1	Connection piece. Diameter: 6 to 1/8"
1	Allen key with cross handle, 4x150
1	Spacing disc
1	Instruction Manual set

### 8.1.3 Installation - LaboForce-100



**Note**  
This device must be mounted securely on the machine.



**Note**  
Do not use the Turn/push knob knob to move LaboForce-100.



**Procedure**

1. Install the specimen mover in the support hole of the machine.
2. Use the Allen key to tighten the two fastening screws. Do not tighten the screws completely.

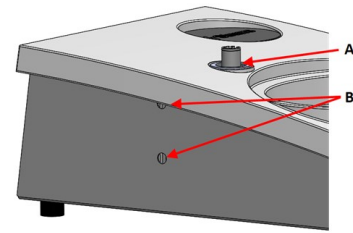

- A** Support hole  
**B** Fastening screws

**8.1.4 Electrical connection to the machine****Hint**

The communication cable in the support hole is not used for LaboForce-100.

The cable attached to LaboForce-100 provides a 24 V power supply and a data bus, which enables the machine and LaboForce-100 to communicate.

1. Switch off the machine.
2. Connect the cable to the LaboForce-100 connector on the back of the machine.

**8.1.5 Compressed-air connections****Procedure****Note**

The main air valve is not a part of the unit and must be installed and set before the specimen mover is installed.

1. Fit the quick coupling on the compressed air hose and secure it with the hose clamp.
2. Connect the air inlet hose to the quick coupling.
3. Fit the other end of the air inlet hose into the compressed air inlet on the specimen mover.

**Note**

The air pressure must be between 6 bar (87 psi) and 9.9 bar (143 psi).

**Hint**

The specimen mover requires a continuous flow of compressed air through the regulator valve – a faint hissing sound does not mean that there is an air leak.

**8.1.6 The specimen mover**

The specimen mover can be used with specimen mover plates for single specimens or specimen holders for multiple specimens.

## Inserting a specimen holder

### Inserting a specimen holder



#### CAUTION

To prevent specimens from detaching from the specimen holder, make sure that the specimen or specimens are clamped securely in the specimen holder.



#### CAUTION

Protective footwear is recommended when you handle heavy specimen holders.



#### CRUSHING HAZARD

Keep your hands clear of the specimen holder or specimen mover plate when lowering the specimen mover.



#### Note

When you work with specimen holders, make sure that the screws clamping the specimens do not stick out of the specimen holder.  
Use different lengths of screws for specimens with different diameters.



#### Hint

The maximum height of specimens in the specimen holder is 32 mm.  
If the specimens exceed 32 mm, the specimen holder cannot be placed in the specimen mover head.

1. Press the **Lower/Raise** button to make sure that the specimen mover head is fully raised.
2. Press the black button on the specimen mover head.
3. Insert the specimen holder and rotate it until the three pins are aligned with the holes in the specimen mover.
4. Push the specimen holder upwards until it locks into position.
5. Release the black button on the specimen mover head. Make sure that the specimen holder is securely fixed.



### Inserting a specimen mover plate

1. Press the **Lower/Raise** button to make sure that the specimen mover head is fully raised.
2. Press the black button on the specimen mover head.
3. Insert the specimen mover plate and rotate it until the three pins are aligned with the holes in the specimen mover.
4. Push the specimen mover plate upwards until it locks in position.
5. Release the black button on the specimen mover head. Make sure that the specimen mover plate is securely fixed.



### Adjusting the height of the specimen mover plate

The following applies only when specimen mover plates are used.

1. With a specimen mover plate mounted, place a preparation surface on the preparation disc.
2. Select the 'thickest' preparation surface to be used and place it on the preparation disc. Usually, this will be SiC Foil on an MD-Gekko disc, or SiC Paper on an MD-Fuga disc, or an MD-Alto.
3. Place the supplied spacing disc on the preparation surface.

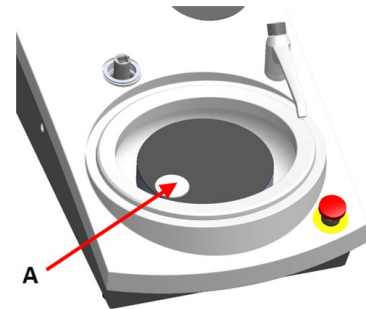

A Spacing disc

4. Support the LaboForce-100 head and loosen the screw in the adjustment ring.

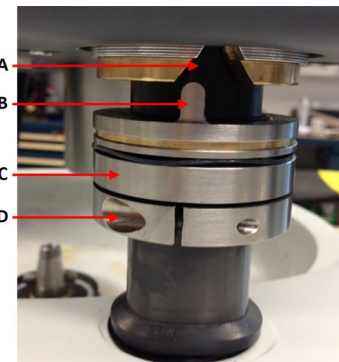

A V-shaped groove  
B Pin  
C Adjustment ring  
D Fastening screw

5. Press the **Lower/Raise** button to lower the specimen mover head. An error message will appear as the specimen mover head is not in contact with the adjustment ring.



6. Move the adjustment ring up until the pin fits into the V-shaped groove on the cabinet of the control panel.
7. Tighten the adjustment ring to fix it in this position.
8. Press the **Turn/push knob** knob to clear the error message.
9. Press the **Lower/Raise** button to raise the specimen mover head.



### Adjusting the horizontal position of the specimen holder or specimen mover plate

With a specimen holder or specimen mover plate mounted:

1. Press the **Lower/Raise** button to lower the specimen mover head.
2. Loosen the 2 fastening screws holding the column of the control panel.
3. Replace the manual splash guard with a splash guard for semi-automatic preparation or splash guard for Wet grinding disc.
4. Moves the specimen mover head to the right.



### With an MD-disc

1. Place the specimen mover plate in a position that allows the specimen to run 3 – 4 mm over the edge of the preparation disc.

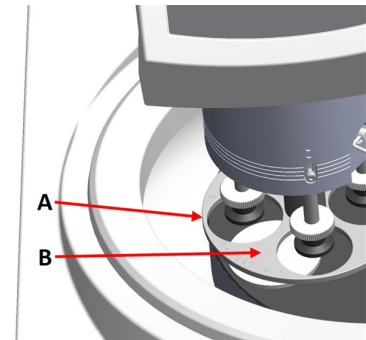

- A** Disc edge  
**B** Specimen mover plate

**With a Wet grinding disc**

1. Place the specimen mover plate in a position 2 – 3 mm from the metal ring.

**Note**

The column can only be turned slightly.  
Do not force it.

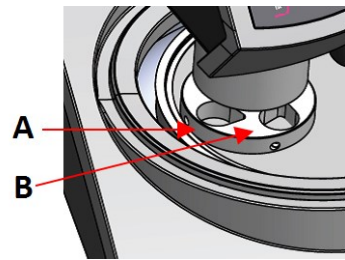

- A** Metal ring  
**B** Specimen holder

**Completing the adjustment**

1. Tighten the 2 fastening screws firmly. The specimen mover will now remain in position.
2. Cover the holes with the two caps.  
Allen key and cover caps are included in the package.

**8.1.7 The flexible specimen holder**

1. From the **Main menu** screen select **Flexible specimen holder methods**.
2. If the menu item **Flexible specimen holder methods** is not available in the main menu, you must activate it in the software:  
Select **Configuration -> Options** and set **Flexible specimen holder** to **Yes**.

**Inserting a flexible specimen holder****CAUTION**

To prevent specimens from detaching from the specimen holder, make sure that the specimen or specimens are covered completely by the flexible specimen holder.

**CRUSHING HAZARD**

Keep your hands clear of the flexible specimen holder when lowering the specimen mover.

**Procedure****Hint**

Make sure that you use sufficient force according to the specimen size and Struers recommendations.

The Struers Metalog Guide methods are based on a specimen with an area of 7 cm<sup>2</sup>.

Adjust the method according to your specific specimen area.

Procedure

**Hint**

Make sure that the preparation surface is sufficiently wet before you start the preparation process.

1. Press the **Lower/Raise** button to make sure that the specimen mover head is fully raised.
2. Press the black button on the specimen mover head.
3. Insert the flexible specimen holder and rotate it until the three pins are aligned with the holes in the specimen mover.
4. Push the flexible specimen holder upwards until it locks into position.
5. Release the black button on the specimen mover head. Make sure that the flexible specimen holder is securely fixed.

**Using the flexible specimen holder**

1. Place the specimen or specimens on the preparation surface.
2. Press the **Lower/Raise** button to lower the flexible specimen holder.
3. Make sure that no specimens protrude from the flexible specimen holder. If they do, adjust the specimens.
  - Press the **Lower/Raise** button to raise the flexible specimen holder.
  - Adjust the specimens.
4. Repeat until all specimens are placed correctly.
5. Start the preparation process.
 

The preparation process stops automatically when the set preparation time has expired.
6. Clean the flexible specimen holder before the next preparation step.

**Adjusting the height of the flexible specimen holder**

The following applies only when a flexible specimen holder is used.

1. With a flexible specimen holder mounted, place a preparation surface on the preparation disc.
2. Select the 'thickest' preparation surface to be used and place it on the preparation disc. Usually, this will be SiC Foil on an MD-Gekko disc, or SiC Paper on an MD-Fuga disc, or an MD-Alto.

- Place a spacing disc at a height of 20 mm on the preparation surface so that it is below the edge of the flexible specimen holder.

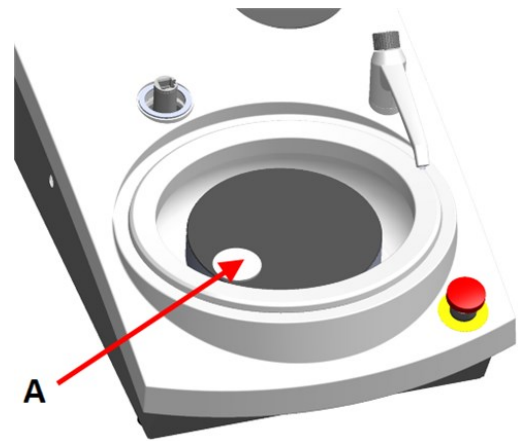

A Spacing disc

- Support the LaboForce-100 head and loosen the screw in the adjustment ring.

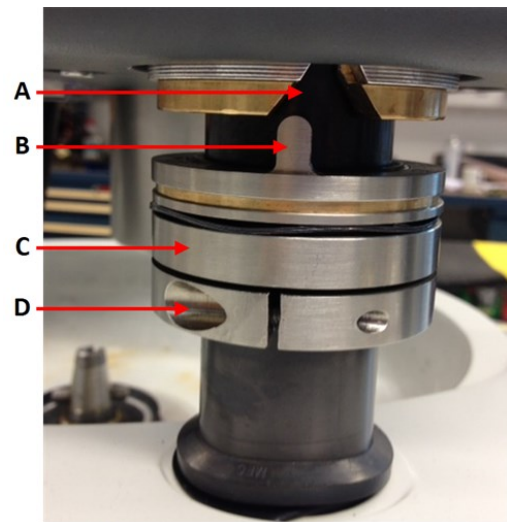

A V-shaped groove  
 B Pin  
 C Adjustment ring  
 D Fastening screw

- Press the **Lower/Raise** button to lower the specimen mover head. An error message will appear as the specimen mover head is not in contact with the adjustment ring.



6. Move the adjustment ring up until the pin fits into the V-shaped groove on the cabinet of the control panel.
7. Tighten the adjustment ring to fix it in this position.
8. Press the **Turn/push knob** knob to clear the error message.
9. Press the **Lower/Raise** button to raise the specimen mover head.



### Adjusting the horizontal position of the flexible specimen holder

With a flexible specimen holder:

1. Press the **Lower/Raise** button to lower the specimen mover head.
2. Loosen the 2 fastening screws holding the column of the control panel.
3. Place the flexible specimen holder in a position that does not allow the specimen to run more than 1 mm over the edge of the preparation disc.



#### 8.1.8 LaboDoser-100 with LaboForce-100

If you are using LaboDoser-100 with LaboForce-100, see the specific machine manual.

#### 8.1.9 LaboDoser-10 with LaboForce-100

If you are using LaboDoser-10 with LaboForce-100, a table stand is required.



## 8.2 Operating the device

### 8.2.1 Control panel functions



#### **CAUTION**

Keep clear of rotating parts during operation.











**CAUTION**

When working at machines with rotating parts, take care to prevent clothes and/or hair from being caught by the rotating parts.



- A Control panel
- B Turn/push knob
- C Specimen mover head
- D Control panel column

Button	Function
	<b>Function key</b> <ul style="list-style-type: none"> <li>Press this button to activate controls for various purposes. See the bottom line of the individual screens.</li> </ul>
	<b>Disc rotation</b> <ul style="list-style-type: none"> <li>Starts rotation of the disc (<b>Spin</b> function).</li> <li>Press this button again to stop the rotation.</li> </ul>
	<b>Lower/Raise</b> <p>Press this button to lowers and raise the specimen mover head when preparing single specimens or when adjusting positions of the specimen mover plate or specimen holder.</p>
	<b>Water</b> <p>Manual override</p> <ul style="list-style-type: none"> <li>Press the button to apply water. Water is applied when no process is running.</li> <li>Press the button again to stop applying water. Water switches off automatically after 5 minutes.</li> </ul>
	<b>Abrasive</b> <p>This function is only active when dosing units are installed.</p> <ul style="list-style-type: none"> <li>Manual override: Press this button to apply diamond suspension from the doser bottle.</li> </ul>
	<b>Lubricant</b> <p>This function is only active when dosing units are installed.</p> <ul style="list-style-type: none"> <li>Manual override: Press this button to apply lubricant from the doser bottle.</li> </ul>

Button	Function
	<p><b>Start</b></p> <ul style="list-style-type: none"> <li>Starts the preparation process.</li> </ul>
	<p><b>Stop</b></p> <ul style="list-style-type: none"> <li>Stops the preparation process.</li> </ul>
	<p><b>Escape</b></p> <ul style="list-style-type: none"> <li>Press this button to return to the previous screen or to cancel functions/changes.</li> </ul>

 <p><b>A</b> Turn/push knob knob</p>	<p><b>The Turn/push knob knob</b></p> <ul style="list-style-type: none"> <li>Turn the <b>Turn/push knob</b> knob to move the focus on the screen and change steps and setting. Press to toggle when only 2 options are available.</li> <li>Press the <b>Turn/push knob</b> knob to select a function or save a selected setting.</li> </ul>
---	---

### 8.2.2 Water tap

#### Applying water automatically

Water is applied when a process is running.

- During grinding, open the nozzle on the water tap to apply water.
- During polishing, close the nozzle on the water tap.



**Note**  
Close the water tap before you start a polishing process.

For optimal results and to avoid splashing, position the water tap between the center and the left edge of the polishing disc.

#### Applying water manually

- To start applying water, press the **Water** button and open the water tap.
- To stop applying water, press the **Water** button or close the water tap.



### 8.2.3 The Spin function

Only use the spin function to rotate the preparation disc at high speed

- to remove water from the surface of the disc.
- to remove water from an MD-Disc or a SiC Foil/SiC Paper before you remove it,
- to dry an MD-Disc or an MD-Chem cloth

**At 150 rpm**

- To start the spin function, press the **Disc rotation** button.
- To stop the spin function, press the **Disc rotation** button again.

**At 600 rpm**

- To start the spin function, press and hold the **Disc rotation** button.
- To stop the spin function, release the **Disc rotation** button.

**8.2.4 The splash guard****Manual preparation**

- The splash guard for manual preparation is supplied with the machine. (For the 300 mm diameter disc)

**Semi-automatic preparation**

- Use the splash guard for semi-automatic preparation.

**Wet grinding (for plain-back SiC Paper)**

- Use the splash guard for the Wet Grinding Disc.

**8.2.5 The display****Note**

The screens shown in this manual may differ from the actual screens in the software.

The display is the user-interface to the software.

When you switch on the machine, the display shows the configuration and the version of the installed software.

The display is divided into some main areas. See this example.

**A Title bar**

The title bar shows the function you have selected.

**B Information fields**

These fields show information about the selected function. In some fields you can select and change the value.

**C Function key options**

The functions shown depend on the screen that is displayed.



**8.2.6 Main menu**

From the **Main menu** screen you can choose between the following options:



- **Specimen holder methods**



- **Single specimen methods**



- **Manual preparation**

You can also access the maintenance and configuration screens.



- **Maintenance**



- **Configuration**

**8.2.7 Navigating in the display**



**The Turn/push knob knob**

Use this knob on the control panel to select menu items.

- Turn the knob to select a menu, a method group or to change a value.
- Press the knob to enter a field or activate the selection.
- Turn the knob to increase or decrease the numeric value, or to toggle between two options.
  - If there are only two options, press the knob to toggle between the two options.
  - If there are more than two options, a pop-up box is shown.

### The Esc button

Use this button on the control panel to return to previous functions or values.

- Press the button to return to the main menu.
- Press the button to return to the last function or value.
- Press the button to cancel changes.



## 8.2.8 Changing settings and text

### Changing text

To change a text value, select the field for entering the text.

1. Press the **Turn/push knob** knob to activate the text editor.
2. If needed, use the **Upper case/Lower case** arrow at the bottom of the screen to switch between upper case and lower case letters.
3. Enter the desired text.
4. Navigate to select **Save & Exit**.
5. Press the **Turn/push knob** knob to exit the screen.



### Changing settings

To change a setting, select the field for changing the setting.

1. Turn the **Turn/push knob** knob to go to the field where you wish to change the setting.
2. Press the **Turn/push knob** knob to enter the field.
  - **More than two options:**  
Turn the **Turn/push knob** knob to scroll up or down in a list of values.
  - **Two options:**  
Press the **Turn/push knob** knob to toggle between the options.
3. Navigate to select **Save & Exit**.
4. Press the **Turn/push knob** knob to exit the screen.



## 8.2.9 Software settings

### Start-up - the first time

See [Navigating in the display ▶ 52](#) for instructions on how to navigate in the display.

**Select language**

1. Select the language you wish to use. If needed, you can change the language at a later date.
  - From the **Main menu** select **Configuration > Options > Language**.
  
2. **Date**  
You will be prompted to set the date.
  
3. **Time**  
You will be prompted to set the time.



**Start-up - daily operation**

When you switch on the machine, the screen that was shown when the machine was switched off is shown just after the start-up screen.

**8.2.10 Configuration**

You can set a number of settings and parameters.

1. From the **Main menu** select **Configuration**.
2. From the **Configuration** menu, select:
  - **User surface configuration** for setting specific parameters.
  
  - **Options** for general settings.



**User surface configuration**

In the **User surface configuration** screen you can create up to 10 user surfaces. From this screen you can also rename and delete user surfaces.

1. From the **Main menu** select **Configuration > User surface configuration**.
  
2. In the **User surface configuration** screen, press **F1** to display a menu where you can create, rename and delete user surfaces.
  
3. Select **Rename** to activate the text editor and enter a name of your choice.



**The Options menu**

From the **Options** menu you can access the following settings:

- **Display brightness**
- **Language**

- **Keyboard sound**
- **Units**
- **Time**
- **Date**
- **Operation mode**
- **Auto continue mode**
- **Time to fill empty tube**
- **Pump cleaning time**
- **Disc diameter**
- **Flexible specimen holder**

### Operation mode

#### User levels

You can select three different user levels as operation mode.

• <b>Production</b>	
Methods	You can select and view methods.
Options	You can edit some settings.

• <b>Development</b>	
Methods	You can select, view and edit methods.
Options	You can edit some settings.

• <b>Configuration</b>	
Methods	You can select, view and edit methods. You can configure bottles.
Options	You can edit all settings.

#### Changing operation mode

To change the operation mode, do the following:

1. From the **Main menu** select **Configuration > Options > Operation mode**.
2. Enter the pass code.
3. Enter the pass code. See [New pass code ► 55](#).
4. When the **Select operation mode** dialog is shown, select the desired operation mode and confirm your selection.

#### New pass code

When you access the **Operation mode** menu, you will be prompted to enter a pass code. The default pass code is '2750'.

### Changing the pass code

You can change the pass code from the **Operation mode** menu.



**Note**  
Make a note of the new pass code.

To change the pass code, do the following:

1. From the **Main menu** select **Configuration > Options**.
2. Select the field for entering the pass code.
3. When the **Enter pass code** dialog is shown, enter the current pass code.  
The default pass code is '2750'.
4. Change the pass code and confirm your selection.

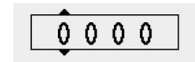

### Auto continue mode

You can set the machine to automatically continue to the next step in a method, as long as the consumables used are the same.

1. Select **Configuration > Options > Auto continue mode**.

Setting	Definition
<b>Off</b>	The machine pauses between each step.
<b>Equal cons. except SiC</b>	The machine automatically continues to the next step, but pauses when grinding with SiC Paper, which must be changed between the steps.
<b>Always</b>	The machine automatically continues to the next step.

### Time to fill empty tube

This function applies when LaboDoser-100 is used with LaboForce-100.

You can set the time for filling the tube:

- if you have installed a new bottle
- after the cleaning procedure.

#### Procedure

1. Select **Configuration > Options > Time to fill empty tube**.
2. If needed, set the time.
3. Confirm your selection.

### Pump cleaning time

This function applies when LaboDoser-100 is used with LaboForce-100.



You can set the time for pumping water through the tubes during the cleaning procedure.

#### Procedure

1. Select **Configuration > Options > Pump cleaning time**.
2. If needed, set the time.
3. Confirm your selection.

#### Disc diameter

LaboForce-100 automatically recalculates process parameters such as time and dosing levels when a disc is changed from a 250 mm diameter disc to a 300 mm diameter disc, or vice versa. There is no need to adjust the method when another disc size is used.

#### Procedure

1. Select **Configuration > Options > Disc diameter**.
2. Select the size of the disc you wish to use.
3. Confirm your selection.

#### Returning to the default value



##### Hint

Make a note of the customized setting before you reset the setting to the default value.

1. To return a setting to the default value, mark the value you wish to reset.
2. Press **F1** on the control panel.

### 8.2.11 Maintenance menu



- **Cleaning of tubes**  
See also [Cleaning the tubes ▶ 79](#).



- **Cleaning of specimen mover head**  
See also [LaboForce-100 - the specimen mover head ▶ 82](#).



- **Reset configuration**  
See also [Resetting the configuration ▶ 57](#).



- **Service information**

#### Resetting the configuration

Resetting the configuration will reset all configuration parameters to their default factory settings.

**Hint**

Make a note of all customized settings before you reset the configuration.

1. From the **Main menu** select **Maintenance > Reset configuration**.
2. Switch LaboForce-100 off, then on again and reconfigure the settings.

## 8.3 The preparation process

### 8.3.1 Preparation modes

From the **Main menu** you can select three different preparation modes:



- **Specimen holder methods**

Specimens are clamped in specimen holders and prepared.



- **Single specimen methods**

Specimens are prepared as single specimens.



- **Manual preparation**

Specimens are prepared manually.

The specimen holder methods and the single specimen methods are initially the same. When you create a method in one of these screens, the same method is automatically created in the other screen.

Except for the force to be applied, all method parameters are initially the same when a method is created. The relation between single specimen force and specimen holder force is 1 to 6. This means that 30 N in single specimen mode equals 180 N in specimen holder mode and vice versa.

If you subsequently change a method parameter such as time, the corresponding method will not be updated with the new values. This means that you can set up individual parameters based on specimen size and/or number.

**Hint**

If a preparation surface or suspension is changed in a method, this will be reflected in the corresponding method.

### Selecting a preparation method

1. From the **Main menu** select a preparation method.

- **Specimen holder methods**

Specimens are clamped in specimen holders and prepared.



or

- **Single specimen methods**

Specimens are prepared as single specimens.



2. Open the method to see the individual preparation steps. The method contains four steps:

Surface, suspension, lubricant and time are shown for each step.

### Editing a preparation method

You can change all parameters to optimize the preparation method.

1. From the **Main menu** select and open a preparation method.

The default settings for a typical preparation process are already set up:

- Step 1 is a plane grinding step.
- Step 2 is a fine grinding step.
- Step 3 is a polishing step.
- Step 4 is a final polishing step.

2. Open the individual steps to change the parameters.
3. Select the parameter you wish to change.

In the bottom left corner of the screen you will see an explanation for the selected parameter.

4. Confirm the new value.
5. Press **Esc** to return to the previous screen.

### Setting dosing levels

If LaboDoser-100 is installed, you can set dosing levels.

When suspensions and/or lubricants are used in a preparation step, you must first select the type of suspension or lubricant, and then the dosing level.

LaboForce-100 automatically recalculates process parameters such as time and dosing levels when a disc is changed from a 250 mm diameter disc to a 300 mm diameter disc, or vice versa. There is no need to adjust the method when another disc size is used. If you need to change the disc diameter, see [LaboForce-100 automatically recalculates process parameters such as time and dosing levels when a disc is changed from a 250 mm diameter disc to a 300 mm diameter disc, or vice versa. There is no need to adjust the method when another disc size is used.](#) ▶ 57.



For **Level** you can set two values: e.g. 2/7 (pre-dosing/dosing).

Option	Pre-dosing	Dosing	Increment
Dosing level	0 - 10	0 - 20	1

#### Example



#### The pre-dosing level [e.g. 2]

This value is the pre-dosing level, the amount of suspension or lubricant which is applied to the surface before the actual preparation step is started.

This lubricates the surface to prevent damage from occurring if the specimens were to run on a dry surface.

Applicable values depend on the frequency of use and surface types. For frequently used surfaces, use a lower value than for surfaces used infrequently.



### The dosing level [e.g. 7]

This value is the dosing level throughout the preparation. This level is set according to the surface types: soft, napped polishing cloths require more lubricant than hard, flat cloths or fine grinding discs.

Fine grinding discs require a lower dosing level of abrasive than polishing cloths.

### Adding preparation method steps

You can add new steps to a preparation method. Preparation methods can have up to 20 steps. New steps are automatically added to the end of the list.

Changes to the steps are saved automatically.

To add or delete steps:

- Press **F1**.



### Adding a preparation method

1. From the **Main menu** select and open a preparation mode.
2. Press **F1** to add, rename or delete methods in the list.



You can save up to 3 methods.

### Changing the specimen holder or specimen mover plate

If you wish to prepare specimens of another diameter, you must use a different specimen holder or specimen mover plate.

See [Inserting a specimen holder ▶ 42](#) and [Inserting a specimen mover plate ▶ 42](#).

### Guidelines for grinding single specimens

Do not use plane grinding with coarse abrasives when preparing single specimens. It is normally not necessary, and the use of coarse abrasives can result in un-plane specimens.

If, for some reason, it is necessary to grind using coarse abrasive, you can improve the planeness by following these guidelines:

- The height of the specimen should be between 8 – 35 mm and should not exceed a specimen diameter multiplied by 0.7 x.  
Example: A specimen with a diameter of 30 mm should not be higher than  $30 \times 0.7 = 21$  mm.
- Use the smallest grain size possible. However, remember that this will increase the overall preparation time.
- Use a mounting resin with a wear resistance similar to the wear resistance of the specimens.
- Use 150 rpm for both grinding disc and specimen mover.
- If you are using lower speeds, decrease the speed on both the disc and the specimen mover.
- Use co-rotation.

- Both the disc and the specimen mover head rotate counter-clockwise.
- Use low force.
- Position the specimen mover head so that the specimens do not pass over the center of the preparation disc.
- Lower the specimen mover plate as much as possible, but make sure that it does not come into contact with the preparation surface.

### Manual preparation

If you cannot prepare a specimen by using a standard specimen mover plate or specimen holder, you can prepare it manually.

When you perform manual preparation, you hold the specimen in your hand and press it firmly onto and across the preparation surface.

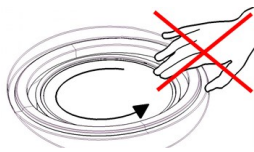

#### CAUTION

Wear suitable gloves to protect fingers from abrasives and warm/sharp specimens.



#### CAUTION

When you perform manual grinding or polishing, be careful not to touch the disc.



#### CAUTION

Do not try to collect a specimen from the tray while the disc is rotating.



#### CAUTION

When the disc is rotating, make sure your hands are kept completely clear of its periphery and out of the splash bowl.

### Procedure

1. From the **Main menu** select **Manual preparation**.
2. If LaboDoser-100 is installed, you can perform the next four steps:
3. If needed, select the suspension bottle number.
4. If needed, select the dosing level.
5. Select the lubricant bottle number.
6. If needed, select the dosing levels or water.
7. Set **Speed** for the disc rotation speed.
8. Set **Time** for the preparation time.
9. See [Starting and stopping the preparation process](#) ► 62.



### 8.3.2 Starting and stopping the preparation process

#### Starting the preparation process



#### WARNING

Do not use the machine with defective safety devices.



#### CAUTION

When working at machines with rotating parts, take care to prevent clothes and/or hair from being caught by the rotating parts.



#### CAUTION

Keep clear of rotating parts during operation.



#### Note

We recommend that an exhaust system is applied when alcohol-based suspension or lubricants are used.

1. Select the desired preparation method, and if needed the desired step.
2. Press the **Start** button on the control panel to start the preparation.  
The disc will start turning at the pre-set speed, and dosing will start.  
The step being performed is highlighted in green on the screen.



#### Pausing the preparation process

1. To pause the process, press the **Stop** button.  
The step being paused is highlighted in orange on the screen.
  2. The process is paused. The **Pause** icon is shown on the display.
- To continue the preparation, press the **Start** button.



#### Stopping the preparation process

The process stops automatically when the set preparation time has expired.

1. To stop the process before the set preparation time has expired, press the **Stop** button.  
The step being stopped is highlighted in orange on the screen.
2. The process is paused. The **Pause** icon is shown on the display.



- To stop the preparation completely, press the **Stop** button again.



### Emergency stop



**Note**

Activating the emergency stop on the machine will stop all movable parts.



**Note**

Do not use the emergency stop for operational stop of the machine during normal operation.

- Press the emergency stop button to activate an emergency stop.



**WARNING**

Before you release the emergency stop, investigate the reason for activating the emergency stop and take any necessary corrective action.

- Turn the emergency stop button to release the emergency stop.

## 9 LaboForce-Mi

### Front view

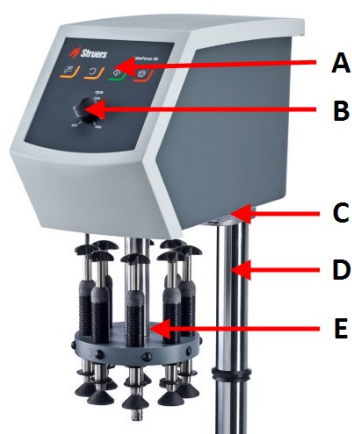

- A Control panel
- B Disc speed control
- C LED light (not shown)
- D Control panel column
- E Force adjustment column

**Rear view**

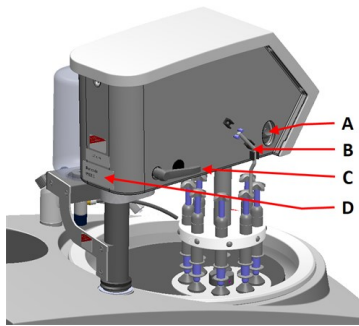

- A** Rotation switch (Specimen mover head)
- B** Steel pin
- C** Locking handle
- D** Type plate

## 9.1 Installation

### 9.1.1 Unpacking

**Note**  
Struers recommends that all original packaging and fittings are kept for future use.

1. Cut the packing tape on the top of the box.
2. Remove the loose parts.
3. Remove the unit from the box.

### 9.1.2 Checking the packing list

Optional accessories may be included in the packing box.

The packing box contains the following items:

Pcs.	Description
1	LaboForce-Mi
1	Spacing disc
1	Instruction Manual set

### 9.1.3 Installation - LaboForce-Mi

**Note**  
This device must be mounted securely on the machine.

**Note**  
Do not use the speed control knob on the control panel to move the specimen mover.

**Procedure**

Install the specimen mover in the connection hole of the machine.



1. Remove the plastic disc protecting the communication cable.
2. Connect the communication cable on the column to the connection port on the machine.

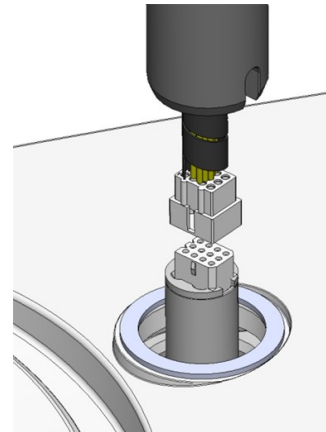

3. Slide the black V-ring down the column until it covers the connection hole.
4. Use the Allen key to tighten the two fastening screws. Do not tighten the screws completely.

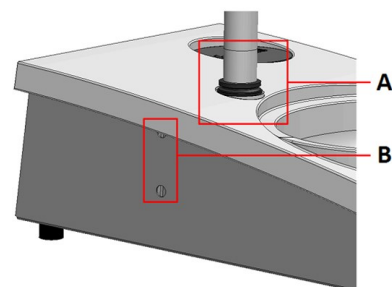

- A V-ring
- B Fastening screws

#### 9.1.4 The specimen mover

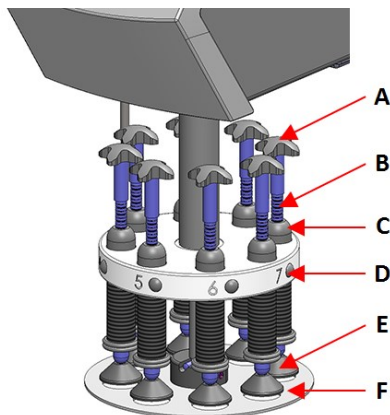

- A Mover cross for forced rotation
- B Force adjustment screw
- C Force indicator
- D Quick-release button
- E Pressure feet
- F Specimen mover plate

### Inserting a specimen mover plate

1. Insert a specimen mover plate and push until the pin is aligned in the groove.
2. Make sure that the specimen mover plate is securely mounted.

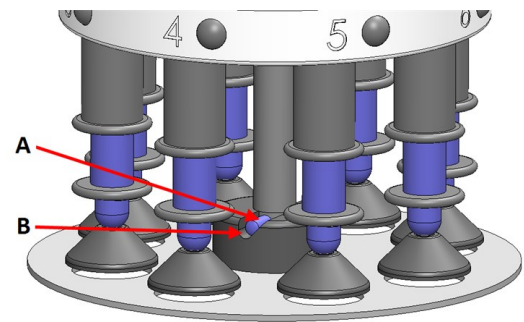

**A** Pin  
**B** Groove

### Adjusting the height of the specimen mover plate

1. Use the locking handle on the left side to unlock the specimen mover and let it move into upright position.
2. Select the ‘thickest’ preparation surface to be used and place it on the preparation disc. Usually, this will be SiC Foil on an MD-Gekko disc, or SiC Paper on an MD-Fuga disc, or an MD-Alto.
3. Place the supplied spacing disc on the preparation surface.
4. Support the specimen mover head and loosen the 2 fastening screws that hold the column.
5. Lift and support the specimen mover.
6. Press the specimen mover head down as far as possible.
7. Use the locking handle to lock the specimen mover head in operating position.
8. Lower the column until the specimen mover plate rests on the spacing disc.
9. Adjust the horizontal position of the specimen mover plate.

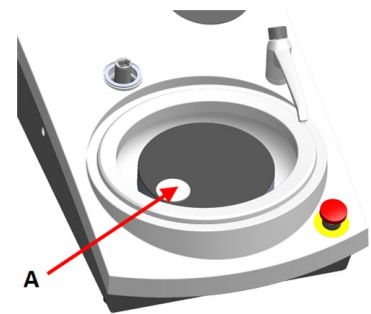

**A** Spacing disc

See [Adjusting the horizontal position of the specimen mover plate](#) ► 67.

## Adjusting the horizontal position of the specimen mover plate

- Moves the specimen mover head to the right.
- Place the specimen mover plate in a position that allows the specimen to run 3 – 4 mm over the edge of the preparation disc.

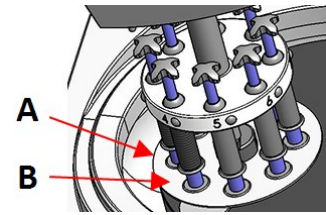

- A** Disc edge  
**B** Specimen mover plate

## Completing the adjustment

- Tighten the 2 fastening screws firmly. The specimen mover will now remain in position.
- Cover the holes with the two caps.  
Allen key and cover caps are included in the package.

## 9.2 Operating the device

### 9.2.1 Control panel functions



#### CAUTION

Keep clear of rotating parts during operation.





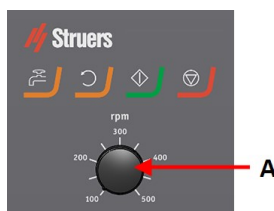

#### CAUTION

When working at machines with rotating parts, take care to prevent clothes and/or hair from being caught by the rotating parts.



- A** Disc speed control

Button	Function
	<p><b>Disc rotation</b></p> <ul style="list-style-type: none"> <li>Starts rotation of the disc (<b>Spin</b> function).</li> </ul>
	<p><b>Water</b></p> <p>Manual override</p> <ul style="list-style-type: none"> <li>Press the button to apply water. Water is applied when no process is running.</li> <li>Press the button again to stop applying water.</li> </ul>
	<p><b>Start</b></p> <ul style="list-style-type: none"> <li>Starts the preparation process.</li> </ul>
	<p><b>Stop</b></p> <ul style="list-style-type: none"> <li>Stops the preparation process.</li> </ul>

### 9.2.2 Water tap

#### Applying water automatically

Water is applied when a process is running.

- During grinding, open the nozzle on the water tap to apply water.
- During polishing, close the nozzle on the water tap.



**Note**  
Close the water tap before you start a polishing process.

For optimal results and to avoid splashing, position the water tap between the center and the left edge of the polishing disc.

#### Applying water manually

- To start applying water, press the **Water** button and open the water tap.
- To stop applying water, press the **Water** button or close the water tap.



### 9.2.3 The Spin function

Only use the spin function to rotate the preparation disc at high speed

- to remove water from the surface of the disc.
  - to remove water from an MD-Disc or a SiC Foil/SiC Paper before you remove it,
  - to dry an MD-Disc or an MD-Chem cloth
- 
- To start the spin function, press and hold the **Disc rotation** button.
  - To stop the spin function, release the **Disc rotation** button.



### 9.2.4 The splash guard

- |                                   |  |
|-----------------------------------|--|
| <b>Manual preparation</b>         | <ul style="list-style-type: none"> <li>The splash guard for manual preparation is supplied with the machine. (For the 300 mm diameter disc)</li> </ul> |
| <b>Semi-automatic preparation</b> | <ul style="list-style-type: none"> <li>Use the splash guard for semi-automatic preparation.</li> </ul>   |

### 9.2.5 Inserting a specimen

- Press the quick-release button.
- Lift the force indicator column to make room for the specimen.
- Place the specimen in one of the holes of the specimen mover plate and lower the force indicator column.
- Each position is marked for easy identification of the individual specimen.

### 9.2.6 Adjusting the force

There are two ways to adjust the force.



**Note**

Make sure that the pressure feet that are not in use do not touch the preparation surface. If necessary, press the release button and move upwards the pressure feet not being used.

#### Coarse adjustment

- Press the quick release button.
- Move the column up or down to approximately the correct force.

#### Fine adjustment

- To adjust the force, turn the force adjustment screw.
- The marks on the spring-loaded force indicator column correspond to the actual force in Newton as stated in this table:

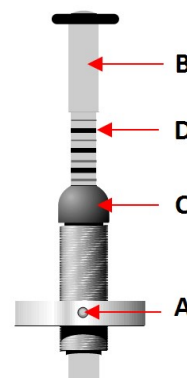

Indication	Force
0	0 N
1 —	2.5 N
2 —	5 N

Indication	Force
3	7.5 N
4	10 N
5	12.5 N
6	15 N
7	17.5 N
8	20 N

**9.2.7 Forced rotation of specimens**

To avoid directional abrasion of the specimens during preparation, LaboForce-Mi can carry out forced rotation of the specimens.

**Using forced rotation**

- Move the angled stainless-steel pin down and press it into the clips on the left-hand side of LaboForce-Mi.

**Stopping forced rotation**

- Move the angled stainless-steel pin up and press it into the clips on the left-hand side of LaboForce-Mi.

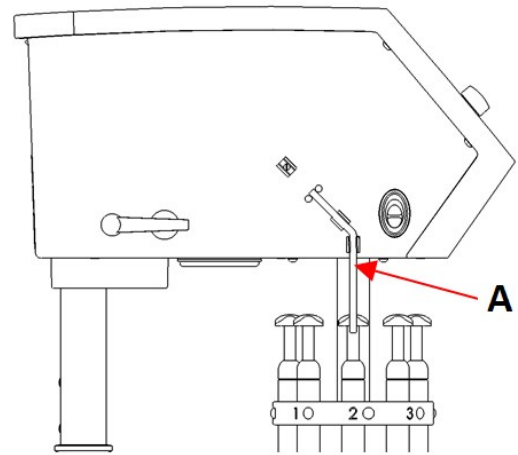

**A** Steel pin

**9.2.8 Manual preparation**

If you cannot prepare a specimen by using a standard specimen mover plate or specimen holder, you can prepare it manually.

When you perform manual preparation, you hold the specimen in your hand and press it firmly onto and across the preparation surface.

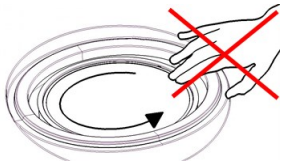
**CAUTION**

For manual preparation use the switch on the side of the specimen mover head to disable rotation of LaboForce-Mi.

**CAUTION**

Wear suitable gloves to protect fingers from abrasives and warm/sharp specimens.

**CAUTION**

When you perform manual grinding or polishing, be careful not to touch the disc.

**CAUTION**

Do not try to collect a specimen from the tray while the disc is rotating.

**CAUTION**

When the disc is rotating, make sure your hands are kept completely clear of its periphery and out of the splash bowl.

## 9.2.9 Starting and stopping the machine

### Starting the machine

**WARNING**

Do not use the machine with defective safety devices. Contact Struers Service.

**CAUTION**

When working at machines with rotating parts, take care to prevent clothes and/or hair from being caught by the rotating parts.

**CAUTION**

Keep clear of rotating parts during operation.

**Note**

We recommend that an exhaust system is applied when alcohol-based suspension or lubricants are used.

1. Set the speed control to the desired disc speed.
2. Press the **Start** button. The machine starts operating.
3. If needed, adjust the disc speed.





### Stopping the machine

- Press the **Stop** button.



### Emergency stop

 **Note**  
Activating the emergency stop on the machine will stop all movable parts.

 **Note**  
Do not use the emergency stop for operational stop of the machine during normal operation.

1. Press the emergency stop button to activate an emergency stop.



 **WARNING**  
Before you release the emergency stop, investigate the reason for activating the emergency stop and take any necessary corrective action.

2. Turn the emergency stop button to release the emergency stop.

### 9.2.10 Removing the specimens

1. To release the specimens, press the quick-release button.
2. When you have removed the specimens, lower the pressure feet back into position.

### 9.2.11 Changing the specimen mover plate

If you wish to prepare specimens of another diameter, use a different specimen mover plate. The specimens must fit the holes in the specimen mover plate.



1. Pull the specimen mover plate down and remove it from the shaft.
2. Insert a specimen mover plate and push until the pin is aligned in the groove.
3. Make sure that the specimen mover plate is securely mounted.
4. Make sure that the specimen mover plate is in a horizontal position.
5. The specimen mover plate must be positioned to allow the specimen to run 3 – 4 mm over the edge of the preparation disc.

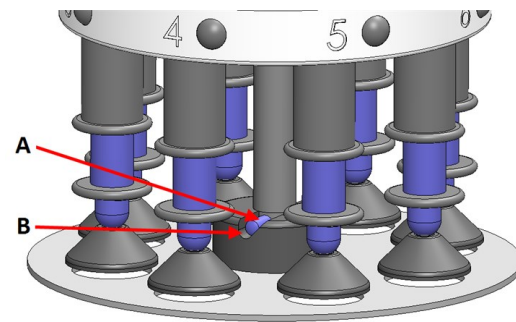

- A** Pin  
**B** Groove

See [Adjusting the horizontal position of the specimen mover plate ▶ 67](#).

## 10 LaboDoser-10

LaboDoser-10 is a drip lubricator for delivering an uninterrupted flow of suspension or lubricant on a preparation disc in the preparation (grinding or polishing) of materials for further materialographic inspection.

The device is designed to be used with Struers consumables specially designed for this purpose and this type of device.

LaboDoser-10 can be mounted on:

- LaboUI
- LaboForce-50
- LaboForce-Mi

Alternatively, LaboDoser-10 can be placed on a LaboDoser-10 table stand.

### LaboDoser-10 mounted on LaboPol

- A** LaboDoser-10 suspension/lubricant bottle  
**B** Adjustable valve  
**C** Dosing nozzle  
**D** Preparation disc



## LaboDoser-10 mounted on a LaboDoser-10 table stand



### 10.1 Unpacking



#### Note

Struers recommends that all original packaging and fittings are kept for future use.

1. Cut the packing tape on the top of the box.
2. Remove the loose parts.
3. Remove the unit from the box.

### 10.2 Checking the packing list

The packing box contains the following items:

Pcs.	Description
1	LaboDoser-10 unit with 1 liter bottle
1	Allen key 3 mm
1	Bracket for doser arm
2	Hexagonal socket screws
1	Instruction Manual set

### 10.3 Installation



#### Hint

If lubricant or suspension is not to be used for a prolonged period of time, remove the bottle from the bottle holder and store it upright.

LaboDoser-10 can be mounted on the column of the following units:

- LaboUI
- LaboForce-50
- LaboForce-Mi

## Procedure



### Note

This does not apply to LaboForce-100.

1. Use the bracket and the two screws to mount the dosing arm on the column of the machine.
2. Attach the bottle cap with adjustable valve onto a Struers suspension/lubricant bottle. For 500 ml bottles, remove the lower part of the tube.
3. Insert the bottle into the doser arm.

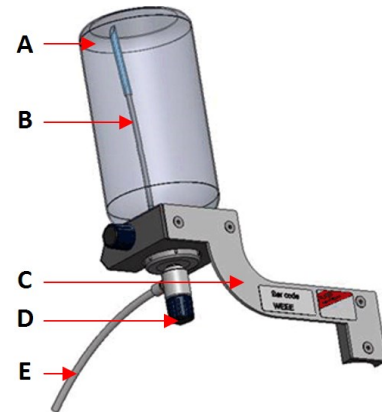

- A suspension/lubricant bottle
- B Suction tube
- C Doser arm
- D Adjustable valve
- E Dosing nozzle

### LaboDoser-10 with LaboForce-100

A table stand (optional) is required for using LaboDoser-10 with LaboForce-100.



## 10.4 Operating LaboDoser-10

The operator adjusts a valve to deliver the required amount of suspension or lubricant on the preparation disc.

1. Place the dosing nozzle in the optimal position over the preparation disc.
2. Open the valve and adjust the suspension/lubricant dosing level.
3. When the preparation step has been completed, close the valve to stop dosing.

## 10.5 Changing lubricant/suspension

Struers recommends using a separate bottle cap for each consumable.

To use the bottle cap with another consumable:

1. Remove the bottle.
2. Hold the bottle firmly and remove the bottle cap.

3. Empty the bottle and fill it with a mild soap solution.
4. Open the valve and clean the tube.
5. Exchange the soap water with clean water and repeat the above procedure.
6. Put the bottle cap on a Struers lubricant/suspension bottle.

# 11 LaboDoser-100

## Front view

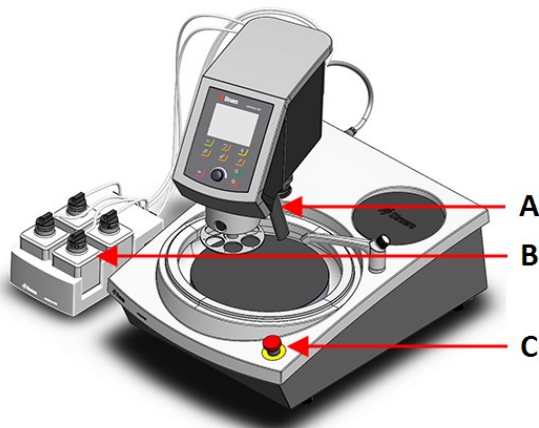

- A Dosing block with nozzles
- B LaboDoser-100
- C Emergency stop (on LaboPol)

## Rear view

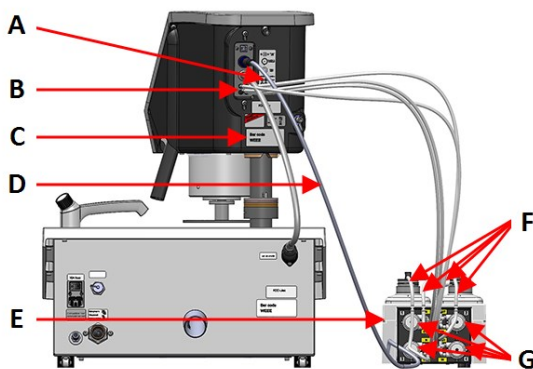

- A Label showing numbered connections
- B Connections for long pump tubes
- C Type plate
- D Electrical cable supplying power to the pumps
- E LaboDoser-100
- F Short pump tubes
- G Pumps

## 11.1 Installation

### 11.1.1 Unpacking

**Note**

Struers recommends that all original packaging and fittings are kept for future use.

1. Cut the packing tape on the top of the box.
2. Remove the loose parts.
3. Remove the unit from the box.

### 11.1.2 Checking the packing list

Optional accessories may be included in the packing box.

The packing box contains the following items:

Pcs.	Description
1	LaboDoser-100
4	Suspension/lubricant (500 ml)
1	Set of tubes <ul style="list-style-type: none"> <li>• 4 short tubes from bottles to pumps</li> <li>• 4 long tubes from pumps to LaboDoser-100</li> </ul>
1	Spiral cable wrap to wrap around the tubes
4	Silicone tubes for the pump for alcohol-based products
1	Instruction Manual set

### 11.1.3 Installing LaboDoser-100



**Note**

The pumps and the connections on the back of the specimen mover are numbered to help you connect the tubes to the correct pump.

1. Place LaboDoser-100 next to the machine.
2. If needed, fill the bottles with suspension and/or lubricant.
3. Fit the bottle caps with tubes onto the Struers 500 ml suspension bottles.
4. Connect the short tubes from the bottles to the pumps marked **IN**.
5. Connect one end of the long tubes to the back of the specimen mover.
6. Connect the other end of the long tubes to the pumps marked **OUT**.
7. Make sure that the tubes are not taut, so that the control panel head can be moved freely.
8. Connect the electrical cable to the connectors on the pump and the specimen mover.
9. Wrap the section of spiral cable wrap around the electrical cables and the tubes.

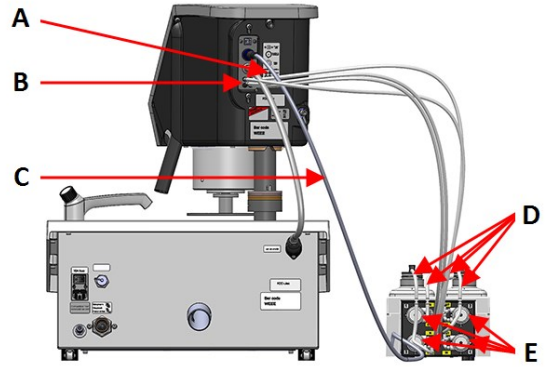
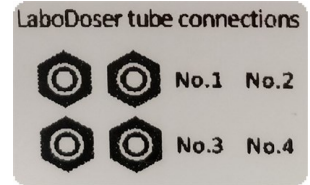



- A** Label showing numbered connections
- B** Connections for long pump tubes
- C** Electrical cable supplying power to the pumps
- D** Short pump tubes
- E** Pumps

## 11.2 Operating LaboDoser-100

LaboDoser-100 can only be operated from LaboForce-100.

The following buttons on the LaboForce-100 control panel apply specifically to operating LaboDoser-100:

Button	Function
	<p><b>Abrasive</b></p> <p>This function is only active when dosing units are installed.</p> <ul style="list-style-type: none"> <li>• Manual override: Press this button to apply diamond suspension from the doser bottle.</li> </ul>
	<p><b>Lubricant</b></p> <p>This function is only active when dosing units are installed.</p> <ul style="list-style-type: none"> <li>• Manual override: Press this button to apply lubricant from the doser bottle.</li> </ul>

### 11.2.1 Changing lubricant/suspension

Struers recommends using a separate bottle cap for each consumable.

To use the bottle cap with another consumable:

1. Remove the bottle.
2. Hold the bottle firmly and remove the bottle cap.

3. Empty the bottle and fill it with a mild soap solution.
4. Open the valve and clean the tube.
5. Exchange the soap water with clean water and repeat the above procedure.
6. Put the bottle cap on a Struers lubricant/suspension bottle.

### 11.2.2 Cleaning the tubes

Clean the tubes when you switch between different types of lubricants/suspensions.



#### Hint

If the equipment is not to be used for a prolonged period of time, Struers recommends that you clean the tubes.

LaboForce-100 is equipped with an automatic cleaning function for flushing the tubes between the bottles and the dosing nozzles.

#### Procedure

1. From the **Main menu** select **Maintenance > Cleaning of tubes**.
2. Select the tubes you wish to clean.
  - Bottle No.:** Identification of the bottle in the doser.
  - Status: **Clean** or **Used**.
  - Selected:** **No** or **Yes**.
3. Press **F1** to start the cleaning process.
4. Follow the on-screen instructions.



### 11.2.3 Changing the pump tubes

When you use alcohol-based lubricants, the Novoprene tubes mounted in the pumps will harden over time. Silicone has a better resistance against alcohol.

You can replace the tubes with the set of silicone tubes supplied with the unit.

**Procedure**

1. Remove the back plate.
2. Remove the tube from the pump unit:  
The white connector must remain on the tube connected to LaboForce-100.
3. Press the two tabs at the base of the pump and remove the pump from the axle.

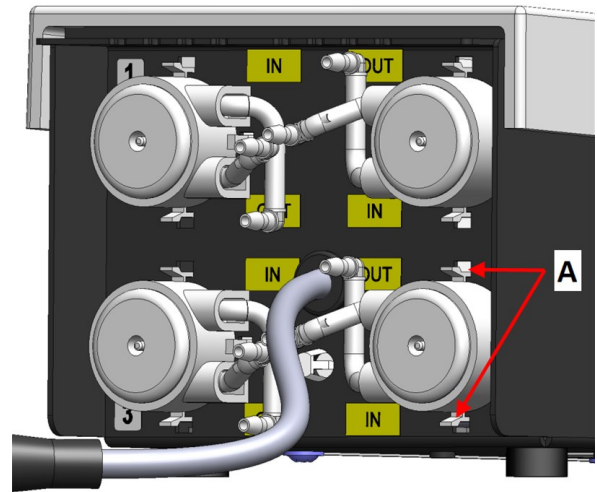

**A** Tabs

4. Remove the three rollers.
5. Remove the Novoprene tube.
6. Make a note of the distance between the two white clips on the Novoprene tube.
7. Move the white clips and the connector to the new silicone tube.
8. Fit the new tube into the housing and press it firmly into place.
9. Press the three rollers into the pump housing.
10. Mount the tube correctly in the pump.





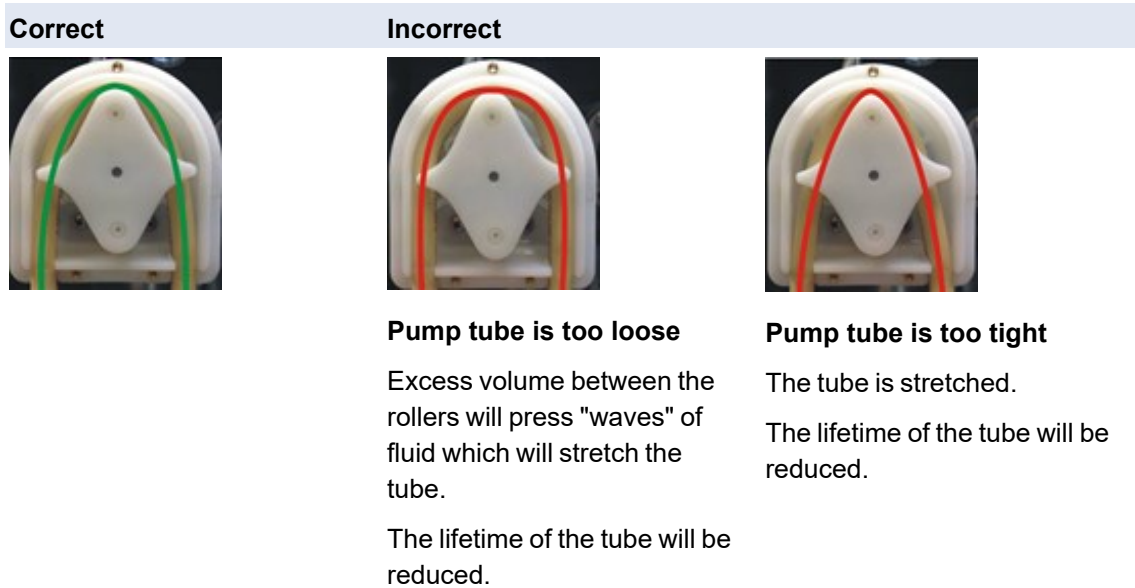

11. Re-mount the bottom cover.
12. Press the pump back onto the axle.
13. Reconnect the tubes.
14. Make sure that the tubes are connected correctly so that liquid is pumped to LaboForce-100.

## 12 Maintenance and service - LaboPol-60

Proper maintenance is required to achieve the maximum up-time and operating lifetime of the machine. Maintenance is important in ensuring continued safe operation of your machine.

The maintenance procedures described in this section must be carried out by skilled or trained personnel.

### Safety Related Parts of the Control System (SRP/CS)

For specific safety related parts, see the section "Safety Related Parts of the Control System (SRP/CS)" in the section "Technical data" in this manual.

### Technical questions and spare parts

If you have technical questions or when you order spare parts, state serial number and voltage/frequency. The serial number and the voltage are stated on the type plate of the machine.

## 12.1 General cleaning

To ensure a longer lifetime for your machine, Struers strongly recommends regular cleaning.

**Note**

Do not use a dry cloth as the surfaces are not scratch resistant.

**Note**

Do not use acetone, benzol or similar solvents.

**If the machine is not to be used for a longer period of time**

- Clean the machine and all accessories thoroughly.

## 12.2 Daily

- Clean all accessible surfaces with a soft, damp cloth.
- Check the bowl liner and clean or dispose of it when it is filled with debris.

## 12.3 Weekly

- Clean all accessible surfaces with a soft damp cloth and common household detergents.
- For heavy duty cleaning, use a heavy duty cleaning agent such as Solopol Classic.

### 12.3.1 LaboForce-100 - the specimen mover head

#### Cleaning

LaboForce-100 is equipped with a function for cleaning the feet that apply the force on the specimens and also for cleaning the lock that secures the specimen mover plate for single specimens.

The force on the pressure feet is generated by friction pins held in place by the screws in the spring housing.

Clean the pressure feet and pistons applying the force on the specimens and specimen holder.

#### Procedure

1. Press the release outlet valve to drain the water/oil filter. See the section [LaboForce-100 - Emptying the water/oil filter ► 83](#).
2. From the **Main menu** select **Maintenance > Cleaning of specimen mover head**.
3. Press **F1** to activate one of the functions shown.

**Note**

Never force any of the movements. If the components do not move as they should, contact Struers Service.

- |  |   |
|--|---|
| <ul style="list-style-type: none"> <li>– Lower feet</li> <li>– Raise feet</li> <li>– Holder up</li> <li>– Holder down</li> </ul> | <p>The pistons can be cleaned or lubricated.</p> <p>Moves the feet back into operating position.</p> <p>Moves the specimen mover head up for cleaning.</p> <p>Moves the specimen mover head back into operating position.</p> |
|--|---|

## 12.4 Monthly

### 12.4.1 LaboForce-50 - pressure feet

The force on the pressure feet is generated by friction pins held in place by the screws in the spring housing.

- Use an Allen key to tighten the screws.



**A** Screws

### 12.4.2 LaboForce-100 - Emptying the water/oil filter

The specimen mover is fitted with a water/oil filter that removes excessive amounts of water and oil from the compressed air supply.

The filter must be emptied on a regular basis.

#### Procedure

1. Locate the release outlet valve at the bottom of LaboForce-100.
2. Hold a cloth under the release outlet valve and press the valve to empty the water/oil filter.



## 12.5 Annually

### 12.5.1 Testing safety devices

The safety devices must be tested at least once a year.



#### WARNING

Do not use the machine with defective safety devices.  
Contact Struers Service.



#### Note

Testing should always be performed by a qualified technician (electromechanical, electronic, mechanical, pneumatic, etc.).

### 12.5.2 Emergency stop

#### Test 1



1. Press the **Start** button. The machine starts operating.



2. Press the emergency stop.



3. If operation does not stop, press the **Stop** button.

4. Contact Struers Service.

#### Test 2



1. Press the emergency stop.



2. Press the **Start** button.



3. If the machine starts, press the **Stop** button.

4. Contact Struers Service.

## 12.6 Spare parts

#### Technical questions and spare parts

If you have technical questions or when you order spare parts, state the serial number. The serial number is stated on the type plate of the unit.

For further information, or to check the availability of spare parts, contact Struers Service. Contact information is available on [Struers.com](https://www.struers.com).

**Note**

Replacement of safety critical components must only be performed by a Struers engineer or a qualified technician (electromechanical, electronic, mechanical, pneumatic, etc.).

**Note**

Safety critical components must only be replaced by components with at least the same safety level.

## 12.7 Service and repair

Struers recommends that a regular service check be carried out yearly or after every 1500 hours of use.

When the machine is started up, the display shows information about total operation time and the machines service information.

After 1500 hours of operation time, the display will show a message reminding the user that a service check should be scheduled.

**Note**

Service must only be performed by a Struers engineer or a qualified technician (electromechanical, electronic, mechanical, pneumatic, etc.).  
Contact Struers Service.

### Service check

Struers offers a range of comprehensive maintenance plans to suit the requirements of our customers. This range of services is called ServiceGuard.

The maintenance plans include equipment inspection, replacement of wear parts, adjustments/calibration for optimal operation, and a final functional test.

### 12.7.1 Service check - LaboForce-100

Information about total operation time and servicing of the machine is displayed on the screen at start-up.

After 1,500 hours of operation time, a pop-up message will appear to alert the operator that the recommended service interval has been exceeded.

- Contact Struers Service.

### Service information

LaboForce-100 provides extensive information about the condition of the various components.

**Hint**

The service information menus and screens are in English only.  
Use the names and terms shown on the screen when you communicate with your local service technician or Struers Service.

Service information is read-only information. Machine settings cannot be changed or modified.

- From the **Main menu** select **Maintenance > Service functions**.

In the **Service functions** screen you can access a number of screens:

- **Device information**
- **Statistics**
- **Inputs**
- **Outputs**
- **Voltage and temperature monitor**
- **Functional tests**
- **Adjustment and calibration**

Service information can be used in cooperation with Struers Service for remote diagnostics of the equipment.

## 12.8 Disposal



Equipment marked with a WEEE symbol contains electrical and electronic components and must not be disposed of as general waste.

Contact your local authorities for information on the correct method of disposal in accordance with national legislation.

For disposal of consumables and recirculation fluid, follow local regulations.

# 13 Troubleshooting - LaboPol-60

## 13.1 Troubleshooting - LaboPol-60

Error	Cause	Action
Noise when the machine starts, or the turntable will not turn.	The belt is not tight enough.	The belt must be tightened. Contact Struers Service.
The machine does not operate when the start switch is pressed.	The main switch is off.	Turn the main switch on.
	The fuse is blown (located at the back of the machine).	Replace the fuse.
Water is not draining away.	Drain hose squeezed.	Straighten the hose.
	Drain hose clogged.	Clean the hose.
	Drain hose does not slope downwards.	Adjust the hose to an even slope.

<b>Error</b>	<b>Cause</b>	<b>Action</b>
Water dripping underneath the machine.	Leak in water hose or defect in solenoid valve.	Turn the main switch off. Disconnect the unit from the electrical power supply.  Turn the water supply off. Disconnect the unit from the water supply, if needed.  Contact Struers Service.
Cooling water stops	Water tap on water supply closed.	Turn the water on.
	Built-in water tap closed.	Turn the water on.
	Built in water tap blocked	Clean water tap.
	Filter at the water inlet blocked	Clean the filter with compressed air only.

## 13.2 LaboForce-50

<b>Error</b>	<b>Cause</b>	<b>Action</b>
The specimen mover head does not rotate.	Switch is set to "off".	If rotation is required, set the switch to "on".
Specimen holder plate vibrates.	Specimen holder plate screws loose.	Tighten specimen holder plate screws.
	Specimen holder plate unbalanced.	Replace specimen holder plate.
The preparation disc runs unevenly or stops.	Force too high.	Reduce the force.
The preparation disc stops.	Frequency inverter has stopped the equipment.	Switch the equipment off. Wait for a few minutes then restart.  If the error remains: Contact Struers Service.
The specimen mover starts to turn.	Column screws loose.	Tighten the screws immediately.
The specimen mover starts to turn.	Column not securely mounted.	Turn the column until the spacer sits securely in the support hole.
Bad or unusual preparation results from the same method.	Pressure foot turns by itself, leading to differing forces.	Increase friction by tightening the screws in the housing.  See the section "Maintenance".

Error	Cause	Action
Uneven specimens.	Specimens are passing over the center of the disc.	Reposition the horizontal position of the control panel.

### 13.3 LaboForce-100

Error	Cause	Action
Specimen holder plate vibrates.	Specimen holder plate unbalanced.	Replace specimen holder plate.
	Specimen holder plate screws loose.	Tighten specimen holder plate screws.
The preparation disc runs unevenly or stops.	Force too high.	Reduce the force.
The preparation disc stops.	Frequency inverter has stopped the equipment.	Switch the equipment off. Wait for a few minutes then Re-start. If the error remains: Contact Struers Service.
The column starts to turn.	Column screws loose.	Tighten the screws immediately.
Uneven specimens.	Specimens are wider than the radius of the preparation disc.	Use smaller specimens.
	Specimens are passing over the center of the disc.	Reposition the horizontal position of the control panel.
Continuous, irregular wear on a grinding/polishing surface.	Coupling on the specimen holder is worn.	Replace the coupling.

#### 13.3.1 Messages and errors - LaboForce-100

Error messages are divided into two classes:

- Messages and errors

##### Messages

Messages provide information about the machine's status and minor errors.

##### Errors

Errors must be corrected before operation can be continued.

Press **Enter** to acknowledge the error/message.



#	Error Message	Explanation	Action
3	<p><b>Fatal error</b></p> <p><b>Machine failed during Power On Self Testing.</b></p> <p><b>Please reboot the machine.</b></p> <p><b>If the problem persists please contact Struers technical support.</b></p> <p><b>Reason: #__ - Unknown error</b></p>	Failure of internal communication on start-up.	<p>Re-start the machine.</p> <p>If the error remains, contact Struers Service.</p> <p>Make a note of the Reason number.</p>
28	<p><b>Error</b></p> <p><b>Specimen holder cannot be moved down.</b></p> <p><b>Down proximity sensor has not detected bottom position.</b></p>		<p>Make sure that there are no obstacles preventing the movement of the specimen holder.</p> <p>Check the pneumatic system.</p> <p>If the error remains, contact Struers Service.</p>
29	<p><b>Warning</b></p> <p><b>No air or air pressure too low!</b></p>	Pressure of the compressed air supply is too low.	Check the compressed air supply.
30	<p><b>Error</b></p> <p><b>Pressure regulating error!</b></p>	Pressure of the compressed air supply is too high/low.	<p>Check the compressed air supply.</p> <p>Re-start the machine.</p> <p>If the error remains, contact Struers Service.</p>
34	<p><b>Error</b></p> <p><b>Specimen mover plate cannot be moved down.</b></p> <p><b>Down proximity sensor has not detected bottom position.</b></p>		<p>Make sure that there are no obstacles preventing the movement of the specimen mover plate.</p> <p>Check the pneumatic system.</p> <p>If the error remains, contact Struers Service.</p>
46	<p><b>Error</b></p> <p><b>Disc motor RPM's has not been reached.</b></p>	<p>Disc motor will not rotate or cannot reach the set rpm.</p> <p>Polishing process is paused.</p>	<p>Re-start the process.</p> <p>If the error remains, contact Struers Service.</p>

#	Error Message	Explanation	Action
48	<b>Error</b> <b>Frequency inverter error!</b> <b>The disc motor is overloaded.</b> <b>Fault code: 0.0</b> <b>Thermal level: 0%</b>		Wait for the disc motor to cool.  Reduce the force and continue the preparation process.
49	<b>Error</b> <b>The disc motor is overheated!</b> <b>Please wait some minutes and reduce the load.</b> <b>Fault code: 0.0</b>		Wait for the disc motor to cool.  Reduce the force and continue the preparation process.
50	<b>Error</b> <b>Frequency inverter fault!</b> <b>Fault code: 0.0</b>	An error in the frequency inverter is detected.	Re-start the machine.  If the error remains, contact Struers Service.  Please make a note of the Fault code.
53	<b>Error</b> <b>Specimen mover motor power supply out of range or missing!</b>		Re-start the machine.  If the error remains, contact Struers Service.
55	<b>Error</b> <b>No communication to frequency inverter!</b>		Re-start the machine.  If the error remains, contact Struers Service.
58	<b>Warning</b> <b>A bad electrical connection for the following output is detected:</b>		Re-start the machine.  Make a note of the output.  If the error remains, contact Struers Service.
59	<b>Warning</b> <b>Specimen holder motor overload, please reduce the force.</b>		Reduce the force or/and increase the specimen rpms.  Re-start the process.  If the error remains, contact Struers Service.

#	Error Message	Explanation	Action
26	<b>Information</b> <b>Specimen mover plate not lowered!</b>	The pneumatic head with specimen mover plate is not down when the process is started.  Appears if method is started in single specimen mode (SS) and mover plate is not lowered.	Lower the pneumatic head.  Re-start the process.

## 13.4 LaboForce-Mi

Error	Cause	Action
Specimen holder plate vibrates.	Specimen holder plate screws loose.	Tighten specimen holder plate screws.
	Specimen holder plate unbalanced.	Replace specimen holder plate.
The preparation disc runs unevenly or stops.	Force too high.	Reduce the force.
The preparation disc stops.	Frequency inverter has stopped the equipment.	Switch the equipment off.  Wait for a few minutes, then re-start.  If the error remains, contact Struers Service.
The column starts to turn.	Column screws loose.	Tighten the screws immediately.
The force adjustment screw rotates by itself when a specimen passes the centre of the preparation disc.	The friction between the force adjustment screw and the rubber pressure foot is too high.	Add a drop of oil on the contact surface of the rubber pressure foot to reduce the friction.
Uneven specimens.	Specimens are passing over the center of the disc.	Reposition the horizontal position of the control panel.

# 14 Technical data

## 14.1 Technical data

<b>Preparation discs</b>	Diameter	230 mm (9"), 250 mm (10"), 300 mm (12")
	Rotational speed	50-500 rpm, variable
	Spin	600 rpm
	Spin (with LaboForce-100)	150/600 rpm
	Rotational direction	Counter-clockwise
	Motor power , continuous, S1	750 W (1 hp)
	Torque (at 300 rpm)	>24 Nm(Newton meter)
<b>Safety standards</b>		See the Declaration of Conformity
<b>Operating environment</b>	Surrounding temperature	5 - 40°C (41 - 104°F)
	Humidity	< 85% RH non-condensing
<b>Storage and transport conditions</b>	Surrounding temperature	-20 - 60°C (-4 - 140°F)
<b>Power supply</b>	Voltage/frequency	200-240 V/50-60 Hz
	Power inlet	1-phase (N+L1+PE) or 2-phase (L1+L2+PE)  The electrical installation must comply with Installation Category II
	Power, nominal load	1300 W
	Power, idle	16 W
	Current, nominal load	5.7 A
	Current, maximum load	11.2 A
	Current, largest load	5.5 A
<b>Safety Circuit Categories/Performance Level</b>	Emergency stop	PL c, Category 1  Stop category 0
<b>Residual Current Circuit Breaker (RCCB)</b>		Type A, 30 mA (or better) is recommended

<b>Water supply</b>	Pressure, tap water	1 to 9.9 bar (14.5 to 143 psi)1 - 9.9 bar (14.5 - 143 psi)
	Water inlet	Diameter: ½" or ¾"
	Water outlet	Diameter: 40 mm (1½")
<b>Noise level</b>	A-weighted sound emission pressure level at workstations	L <sub>pA</sub> = 67.2 dB(A) (measured value). Uncertainty K = 4 dB
<b>Vibration level</b>	Declared vibration emission	Total vibration exposure to upper parts of the body does not exceed 2.5 m/s <sup>2</sup> .
<b>Dimensions and weight</b>	Width	95 cm (37.4")
	Depth	77.5 cm (30.5")
	Height	25 cm (9.8")
	Weight	50 kg (110 lbs)

## 14.2 Safety Circuit Categories/Performance Level

<b>Safety Circuit Categories/Performance Level</b>	Emergency stop	PL c, Category 1 Stop category 0
--	----------------	-------------------------------------

## 14.3 Noise and vibration levels

<b>Noise level</b>	A-weighted sound emission pressure level at workstations	L <sub>pA</sub> = 67.2 dB(A) (measured value) Uncertainty K = 4 dB Measurements made in accordance with EN ISO 11202
--------------------	--	--

<b>Vibration level</b>	During preparation	Total vibration exposure to upper parts of the body does not exceed 2.5 m/s <sup>2</sup> .
------------------------	--------------------	--

## 14.4 Technical data - equipment units

For technical data covering the individual units of equipment, see the specific equipment manual.

## 14.5 Safety Related Parts of the Control System (SRP/CS)



### WARNING

Safety critical components must be replaced after a maximum lifetime of 20 years. Contact Struers Service.

**Note**

SRP/CS (safety-related parts of a control system) are parts that have an influence on safe operation of the machine.

**Note**

Replacement of safety critical components must only be performed by a Struers engineer or a qualified technician (electromechanical, electronic, mechanical, pneumatic, etc.).  
Safety critical components must only be replaced by components with at least the same safety level.  
Contact Struers Service.

Safety related part	Manufacturer/Manufacturer description	Manufacturer catalog no.	Electrical ref.	Struers catalog no.
Emergency stop button	Schlegel Latching mushroom head	ES Ø22 type RV	S1	2SA10400
Emergency stop contact	Schlegel Modular contact, momentary	1 NC type MTO	S1	2SB10071
Module holder	Schlegel Module holder. 3 elem. MHR-3	MHR-3	S1	2SA41603
Frequency inverter	Lenze	i550-C0.75/230-1, Standard I/O, STO	A2	2PU51075
Relay	Schneider Electric Relay 24 V DC DPDT	RPM21BD	K1	2KL02124
Water valve	ODE	21A2KV20, BDV08024CY	Y1	2YM12120

## 14.6 Diagrams

If you wish to view specific information in detail, see the online version of this manual.

### 14.6.1 Diagrams - LaboPol-60

Title	No.
LaboPol-30/LaboPol-60, Block diagram	<a href="#">16333051 B</a>
LaboPol-30/LaboPol-60, Circuit diagram (2 pages)	<a href="#">16333101 D (2 pages)</a>
LaboPol-60, Water diagram	<a href="#">16341001 A</a>



16333101 D (2 pages)

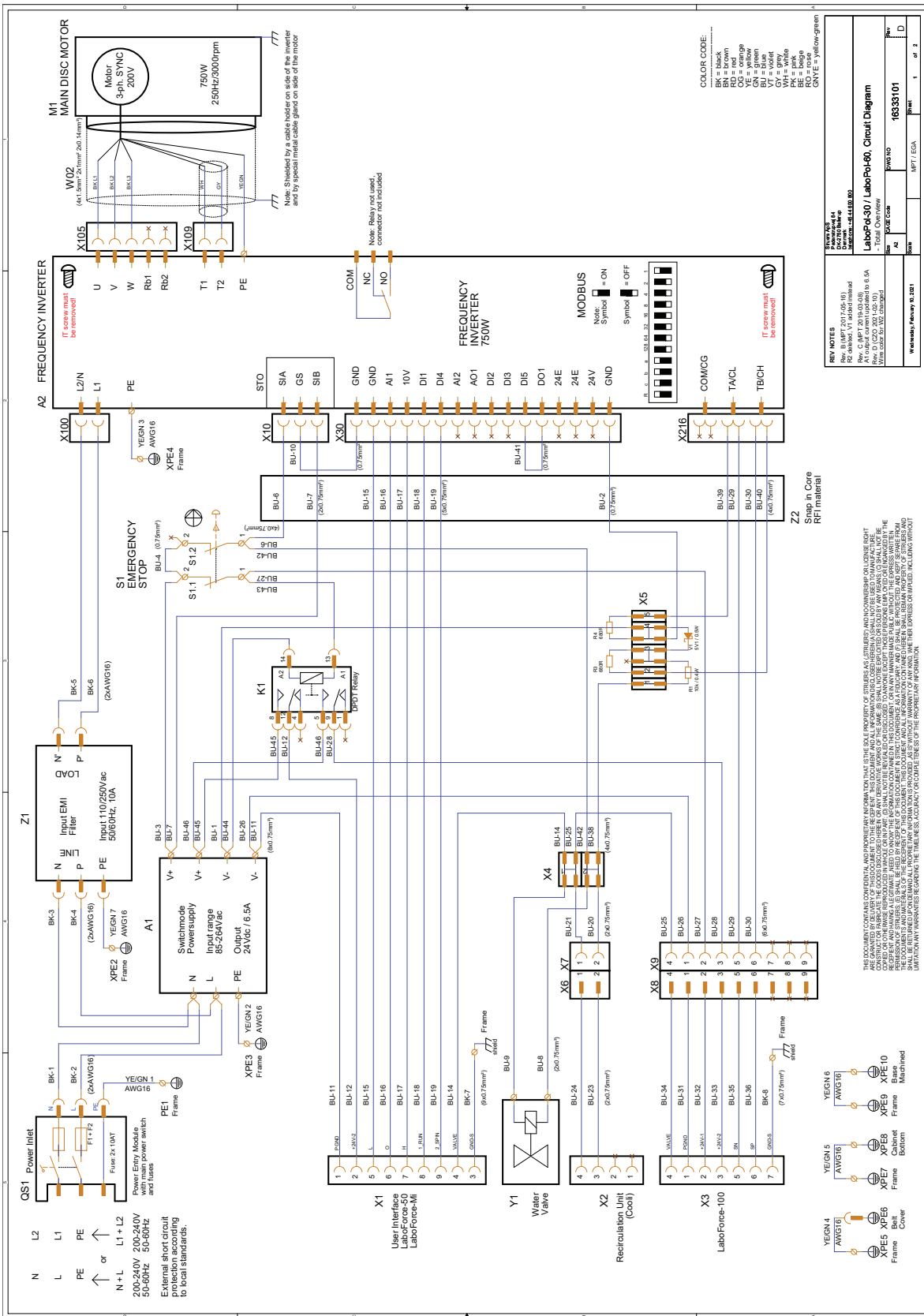





**16341001 A**

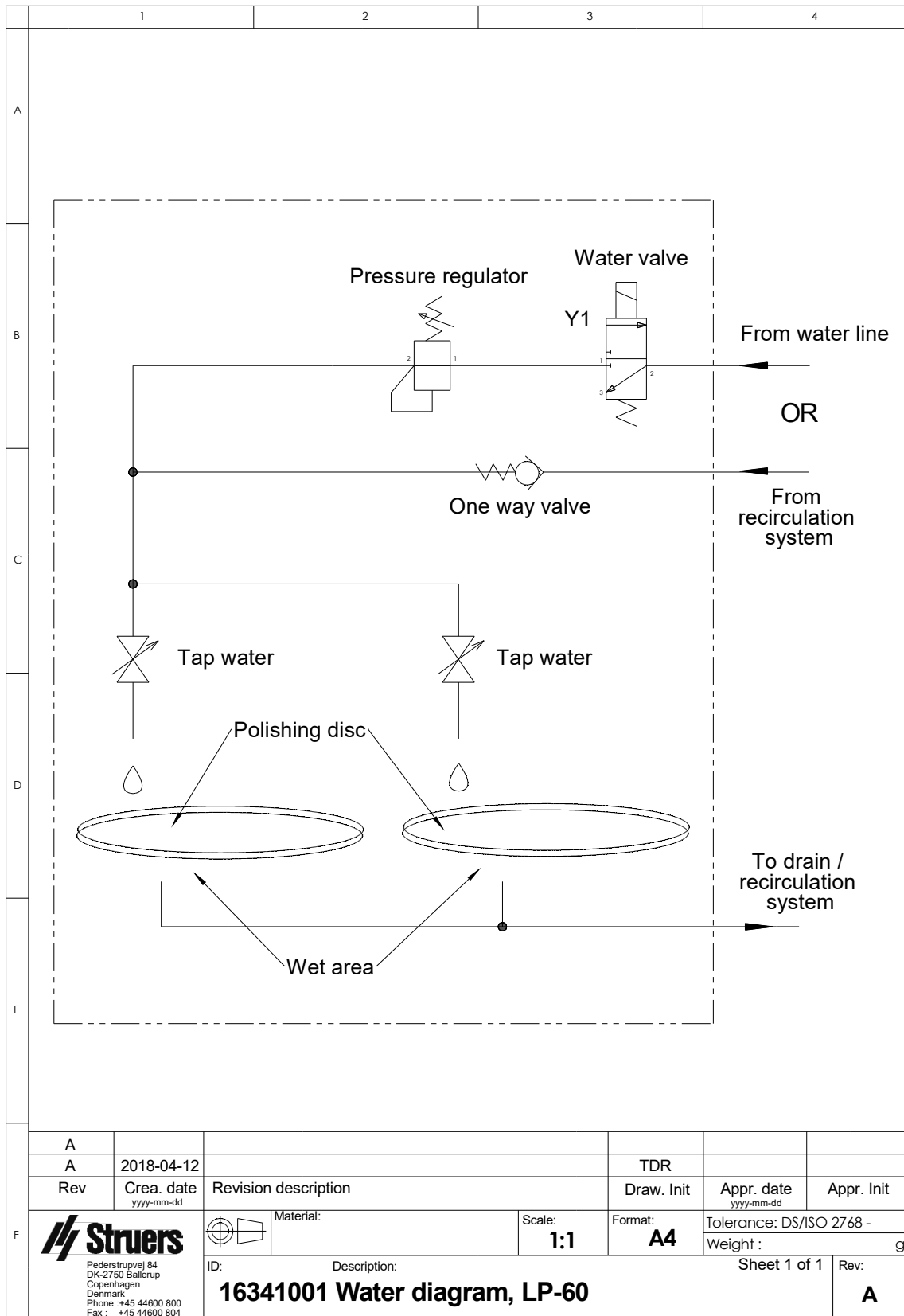

A						
A	2018-04-12			TDR		
Rev	Crea. date yyyy-mm-dd	Revision description		Draw. Init	Appr. date yyyy-mm-dd	Appr. Init
F	<b>Struers</b> Pederstrupvej 84 DK-2750 Ballerup Copenhagen Denmark Phone : +45 44600 800 Fax : +45 44600 804	Material:	Scale: <b>1:1</b>	Format: <b>A4</b>	Tolerance: DS/ISO 2768 - Weight : g	Sheet 1 of 1 Rev: <b>A</b>
		ID:	Description: <b>16341001 Water diagram, LP-60</b>			

### 14.6.2 Diagrams - equipment units

For diagrams covering the individual units of equipment, see the specific equipment manual.

## 14.7 Legal and regulatory information

### FCC notice

This equipment has been tested and found to comply with the limits for a Class B digital device, pursuant to part 15 of the FCC Rules. These limits are designed to provide reasonable protection against harmful interference in a residential installation. This equipment generates, uses and can radiate radio frequency energy and, if not installed and used in accordance with the instructions, may cause harmful interference to radio communications. However, there is no guarantee that interference will not occur in a particular installation. If this equipment does cause harmful interference to radio or television reception, which can be determined by turning the equipment off and on, the user is encouraged to try to correct the interference by one or more of the following measures:

- Reorient or relocate the receiving antenna.
- Increase the separation between the equipment and receiver.
- Connect the equipment into an outlet on a circuit different from that to which the receiver is connected.

# 15 Pre-installation checklist

## 15.1 Installation requirements

### Accessories and consumables

- Control panel (one of the following):
  - LaboUI
  - LaboForce-50
  - LaboForce-100
  - LaboForce-Mi
- Required accessories and consumables that have been ordered separately.  
The use of Struers consumables is recommended.

Other products may contain aggressive solvents, which dissolve e.g. rubber seals. The warranty may not cover damaged machine parts (e.g. seals and tubes), where the damage can be directly related to the use of consumables not supplied by Struers.

For information about the available range, see:

- [The LaboSystem brochure](https://www.struers.com/Products/Grinding-and-Polishing/Grinding-and-polishing-equipment/LaboSystem) (https://www.struers.com/Products/Grinding-and-Polishing/Grinding-and-polishing-equipment/LaboSystem)
- [The Struers Consumables Catalogue](http://www.struers.com/Library) (http://www.struers.com/Library)

## 15.2 Packaging specifications

LaboPol - Dimensions and weight	
<b>X:</b>	Pallet: 100 cm (39.5") Box: 84.2 cm (33.1")
<b>Y:</b>	Pallet: 120 cm (47.5") Box: 108 cm (42.5")
<b>Z:</b>	Pallet: 14.5 cm (5.7") Box: 57.5 cm (22.5")
<b>Weight</b>	Pallet: approx 20 kg (44.1 lbs) Box: 59 kg (130 lbs)

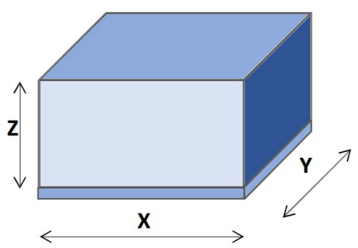

LaboUI - Dimensions and weight	
<b>X:</b>	Box: 23.7 cm (9.3")
<b>Y:</b>	Box: 49.7 cm (19.6")
<b>Z:</b>	Box: 22 cm (8.7")
<b>Weight</b>	Box: 2 kg (4.4 lbs)

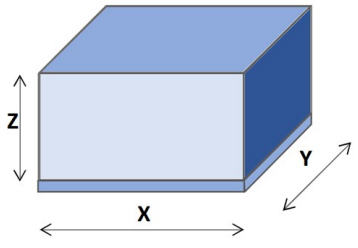

LaboForce-50 - Dimensions and weight	
<b>X:</b>	Pallet: 60 cm (23.6") Box: 53.2 cm (20.9")
<b>Y:</b>	Pallet: 80 cm (31.5") Box: 68.2 cm (26.9")
<b>Z:</b>	Pallet: 13 cm (5.1") Box: 29 cm (11.4")
<b>Weight</b>	Pallet: 6 kg/13.2 lbs Box: 16.5 kg/36.4 lbs

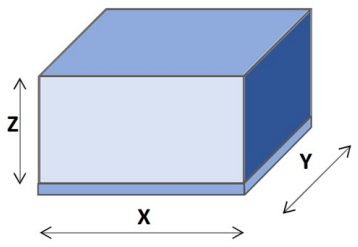

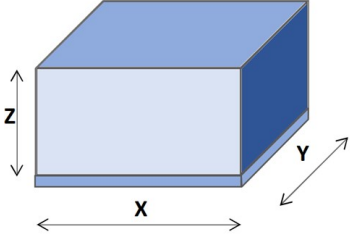
LaboForce-100 - Dimensions and weight		
<b>X:</b>	Pallet: 60 cm (23.6") Box: 56.2 cm (22.1")	
<b>Y:</b>	Pallet: 80 cm (31.5") Box: 67.2 cm (26.5")	
<b>Z:</b>	Pallet: 13 cm (5.1") Box: 31.5 cm (12.4")	
<b>Weight</b>	Pallet: 6 kg (13.2 lbs) Box: 24 kg (52.9 lbs)	

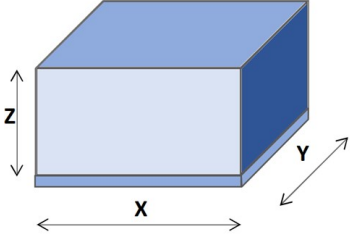
LaboForce-Mi - Dimensions and weight		
<b>X:</b>	Pallet: 60 cm (23.6") Box: 54.2 cm (21.3")	
<b>Y:</b>	Pallet: 80 cm (31.5") Box: 76.2 cm (30")	
<b>Z:</b>	Pallet: 13 cm (5.1") Box: 30 cm (11.8")	
<b>Weight</b>	Pallet: 6 kg (13.2 lbs) Box: 14.5 kg (32 lbs)	

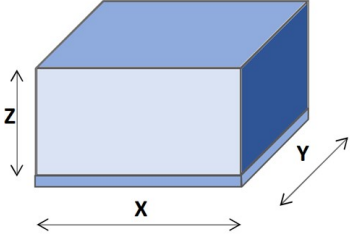
LaboDoser-10 - Dimensions and weight		
<b>X:</b>	Box: 22.8 cm (4.6")	
<b>Y:</b>	Box: 26.8 cm (11.6")	
<b>Z:</b>	Box: 19.9 cm (7.8")	
<b>Weight</b>	Box: 1 kg (2.2 lbs)	

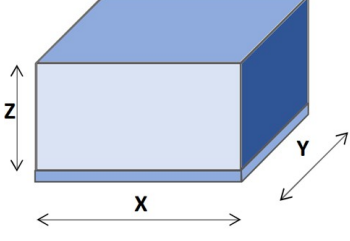
LaboDoser-100 - Dimensions and weight		
<b>X:</b>	Box: 25.2 cm (9.9")	
<b>Y:</b>	Box: 39.2 cm (15.4")	
<b>Z:</b>	Box: 39 cm (15.3")	
<b>Weight</b>	Box: 3 kg (6.6 lbs)	

## 15.3 Location

### Supply requirements

The machine must be placed close to the electrical power supply, main water supply and waste water drain.

Supply type	Required	Not required
Power supply	Required	
Water supply	Required	
Waste water outlet	Required	
Compressed air	Required - for LaboForce-100	
Exhaust		Not required

Ambient conditions		
Operating environment	Surrounding temperature	5-40°C/41-104°F
	Humidity	< 85 % RH non-condensing

### Table or workbench

The machine is designed to be placed on a table or workbench. The Struers table is optional.

The table must be able to carry at least:

<b>LaboUI</b>	60 kg (132 lbs)
<b>LaboForce-50</b>	75 kg (165 lbs)
<b>LaboForce-100</b>	80 kg (176 lbs)
<b>LaboForce-Mi</b>	70 kg (155 lbs)

Recommended table dimensions	
<b>X:</b>	100 cm (40")
<b>Y:</b>	90 cm (35.5")
<b>Z:</b>	80 cm (31.5")

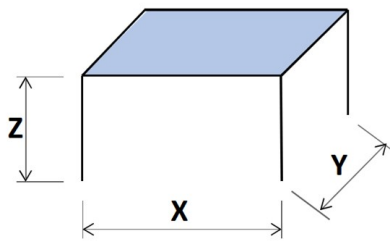

If you are installing a Struers table unit and a Struers recirculation unit, the recirculation cooling unit fits into a compartment in the table unit. If you are installing a Struers recirculation unit with another brand of table, make sure that there is enough space under and at the side of the table for the Struers recirculation cooling unit.

## 15.4 Dimensions

LaboPol - In combination with: LaboUI (optional)	
<b>A:</b>	44 cm (17")
<b>B:</b>	31 cm (12")
<b>C:</b>	78 cm (31")

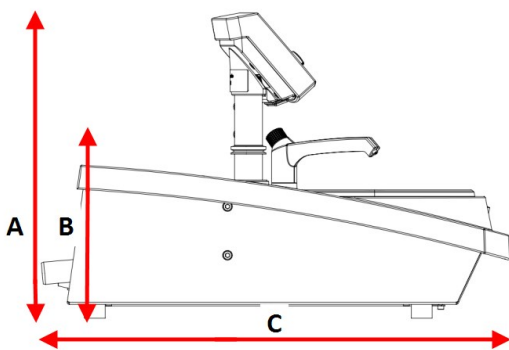

LaboPol - In combination with: LaboForce-50 (optional)	
<b>A:</b>	56 cm (22")
<b>B:</b>	31 cm (12")
<b>C:</b>	78 cm (31")

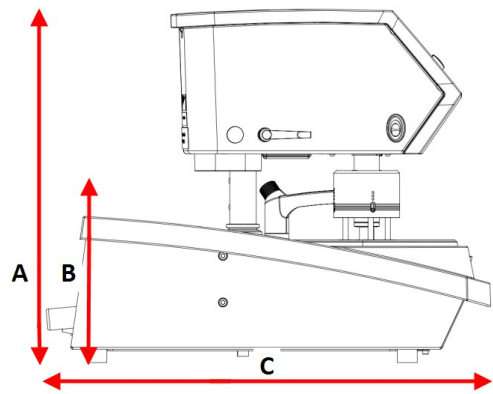

LaboPol - In combination with: LaboForce-100 (optional)		
<b>A:</b>	64 cm (25")	<p>A side-view technical drawing of the LaboPol instrument with the LaboForce-100 optional component. Dimension A is the total height from the base to the top of the LaboForce-100. Dimension B is the height from the base to the top of the main instrument body. Dimension C is the width of the instrument.</p>
<b>B:</b>	31 cm (12")	
<b>C:</b>	78 cm (31")	

LaboPol - In combination with: LaboForce-Mi (optional)		
<b>A:</b>	63.5 cm (25")	<p>A side-view technical drawing of the LaboPol instrument with the LaboForce-Mi optional component. Dimension A is the total height from the base to the top of the LaboForce-Mi. Dimension B is the height from the base to the top of the main instrument body. Dimension C is the width of the instrument.</p>
<b>B:</b>	31 cm (12")	
<b>C:</b>	78 cm (31")	

Center of gravity	
<p>Technical drawing showing the center of gravity for the LaboPol instrument in its upright position. The height from the base to the center of gravity is 10.5cm / 4.1". The width of the instrument is 43.8cm / 17.2".</p>	<p>Technical drawing showing the center of gravity for the LaboPol instrument in its tilted position. The height from the base to the center of gravity is 10.5cm / 4.1". The width of the instrument is 27.9cm / 11.0".</p>



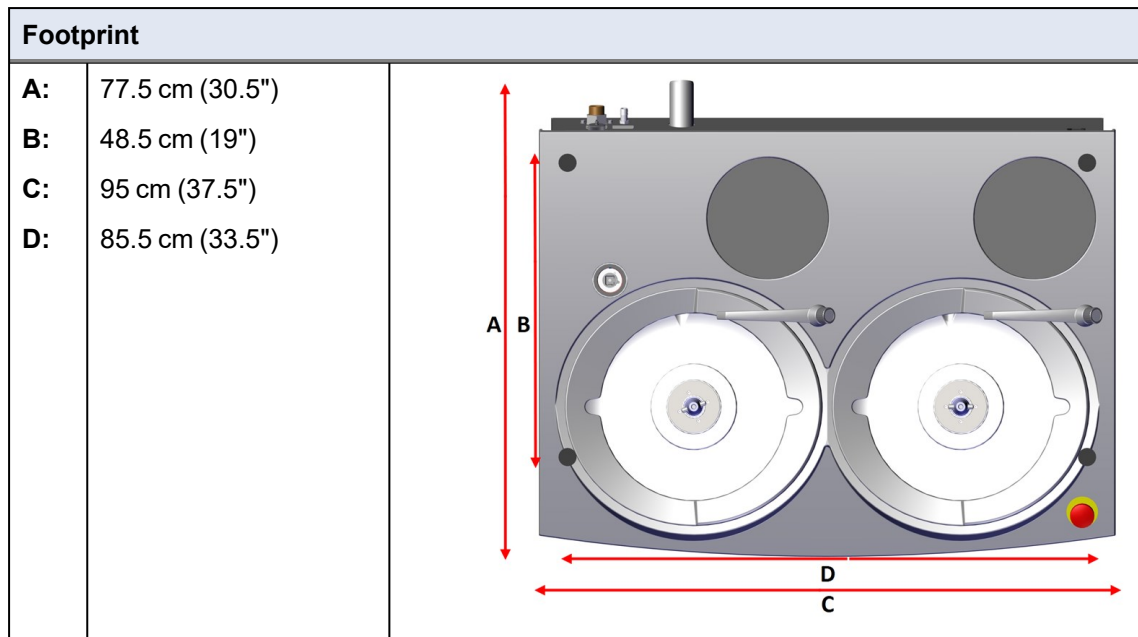

## 15.5 Recommended space

### Space in front of the machine

- Make sure that there is enough room in front of the machine. 100 cm (40")

### Space at the rear of the machine

- The machine can be placed against a wall.
- Make sure that there is enough room behind the machine for the inlet and outlet hoses.

### Space at the sides of the machine

- With LaboForce (optional). Recommended space to the left of the machine for changing the specimen mover plate. 30 cm (12")
- With Lavamin (optional) on one side of the machine. Recommended space at the side of the machine. 40 cm (16")
- With a LaboDoser-100 (optional) on one side of the machine. Recommended space at the side for a LaboDoser-100 bottle tray. 22 cm (8.7")
- With LaboForce and Lavamin. 70 cm (27")

### Space above the machine

- With LaboForce (optional). Minimum free height from the table. 80 cm (32")

## 15.6 Transport and storage

If, at any time after the installation, you have to move the unit or place it in storage, there is a number of guidelines we recommend that you follow.

- Package the unit securely before transportation.  
Insufficient packaging could cause damage to the unit and will void the warranty. Contact Struers Service.
- Struers recommends that all original packaging and fittings are kept for future use.

### 15.6.1 Transport

- Disconnect the unit from the electrical power supply.
- Disconnect the water inlet and the water outlet.
- Disconnect the cooling system, if installed. See the instructions for the specific unit.
- Remove the splash guard, the preparation disc and the bowl liner.
- Lift the machine by gripping the base of the machine from beneath, from both the left side and the right side.



- Alternatively, use a crane and two lifting straps to lift the machine.
- Position the straps under the machine, so that they are on the outer side of the feet.

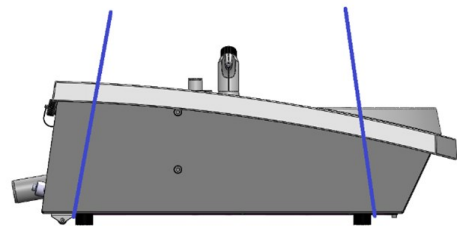

- Lift the machine onto a stable surface.

### 15.6.2 Long-term storage or shipping



**Note**

Struers recommends that all original packaging and fittings are kept for future use.

- Clean the machine and all accessories thoroughly.
- Disconnect the unit from the electrical power supply.
- Disconnect the water inlet and the water outlet.
- Disconnect the cooling system, if installed. See the instructions for the specific unit.
- Remove the splash guard, the preparation disc and the bowl liner.
- Remove the control panel or specimen mover.
- Remove any accessories.

- Lift the machine by gripping the base of the machine from beneath, from both the left side and the right side.
- Place the machine and accessories in their original packaging.
- Secure the boxes on a pallet with straps.

### At the new location

At the new location, make sure that the facilities required are in place.

## 15.7 Unpacking

1. Cut the packing tape on the top of the box.
2. Remove the loose parts.
3. Remove the unit from the box.

## 15.8 Lifting



### CRUSHING HAZARD

Take care of your fingers when handling the machine.  
Wear safety shoes when handling heavy machinery.



### Note

Do not lift the machine by the light gray top part or by the water tap.  
Always lift the machine from beneath.

### Weight

LaboPol-60

50 kg (110 lbs)

1. Lift the machine by gripping the base of the machine from beneath, from both the left side and the right side.

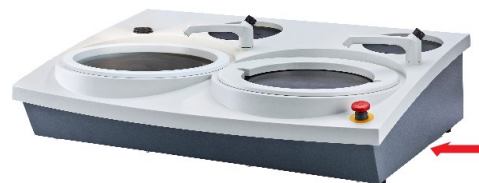

- Alternatively, use a crane and two lifting straps to lift the machine.
- Position the straps under the machine, so that they are on the outer side of the feet.

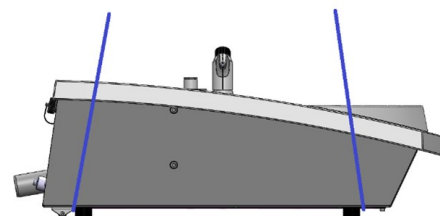

2. Lift the front of the machine and carefully move it onto the table using the rollers at the rear end of the machine.
3. The machine must rest securely with all 4 feet on the table.

## 15.9 Power supply



### **ELECTRICAL HAZARD**

Switch off the electrical power supply before installing electrical equipment. The machine must be earthed (grounded). Make sure that the actual electrical power supply voltage corresponds to the voltage stated on the type plate of the machine. Incorrect voltage can damage the electrical circuit.



### **Note**

The equipment is shipped with 2 types of electrical power cables. If the plug supplied on these cables is not approved in your country, the plug must be replaced with an approved plug.

### **Power socket**

The electrical power supply socket must be easy to access.

The electrical power supply socket must be located at a height ranging from 0.6 m to 1.9 m (2½” to 6”) above floor level. Not higher than 1.7 m (5’ 6”) is recommended.

Cable length: 2.5 m (8.2’).

### **Single-phase supply**

The 2-pin plug (European Schuko) is for use on single-phase electrical power connections.



### **2-phase supply**

The 3-pin plug (North American NEMA) is for use on 2-phase electrical power connections.



Electrical data	
Electrical voltage/frequency	200-240 V/50-60 Hz <div style="border: 1px solid blue; border-radius: 10px; padding: 5px; margin-top: 10px;">  <b>Note</b>            An autotransformer is required in countries with a 110 V electrical power supply.         </div>
Power inlet	1-phase (N+L1+PE) or 2-phase (L1+L2+PE) The electrical installation must comply with Installation Category II
Power, nominal load	1300 W
Power, idle	16 W
Current, nominal load	5.7 A
Current, maximum load	11.2 A
Residual Current Circuit Breaker (RCCB)	Type A, 30 mA (or better) is recommended

Local standards can override the recommendations for the main electrical power supply cable. Always contact a qualified electrician to verify which option is suitable for the local installation setup.

## 15.10 Connection to the machine

- Connect the electrical power cable to the machine (C14 IEC 320 connector).
- Connect the cable to the electrical power supply.



## 15.11 Safety specifications

Safety Circuit Categories/Performance Level	Emergency stop	PL c, Category 1 Stop category 0
---	----------------	-------------------------------------

## 15.12 Water supply

### Water inlet



#### Note

New water pipe installations:  
Leave the water to run for a few minutes to flush any debris from the pipe before connecting the machine to the water supply.

Water supply specifications	
Water pressure	1 to 9.9 bar (14.5 to 143 psi) 1 - 9.9 bar (14.5 - 143 psi)
Hose supplied	Diameter: $\frac{3}{4}$ ". Length: 2 m (7'). With standard connector, filter gasket and reduction ring ( $\frac{3}{4}$ " to $\frac{1}{2}$ ").
Tube connection	$\frac{3}{4}$ " British Standard pipe thread.

**Water outlet - drain****Note**

Make sure that the waste water hose slopes downwards towards the waste water drain throughout its length.

Water outlet specifications	
Hose supplied	Diameter: 40 mm (1.6"). Length: 1.5 m (4.9')

**15.13 Compressed air****Note**

Required for LaboForce-100 (optional).

Compressed air specifications	
Pressure	6 - 9.9 bar/87 - 143 psi
Air consumption, approx.	3.5-4 l/min
Air quality	Class-3, as specified in ISO 8573-1
Hose supplied	6 mm inlet tube (blue) with quick coupling connector

**15.14 Recirculation cooling unit**

The recirculation cooling unit is optional.

**Recommended**

- Struers Cooling System 3
- Struers additive for recirculation cooling unit to prevent corrosion.

Recirculation Cooling Unit specifications	
Power supply	2.5 m (8.2') electrical power cable for connection to a single-phase electrical power supply.
Water supply	2.5 m (8.2') water hose and GEKA connection.

# 16 Manufacturer

Struers ApS  
Pederstrupvej 84  
DK-2750 Ballerup, Denmark  
Telephone: +45 44 600 800  
Fax: +45 44 600 801  
[www.struers.com](http://www.struers.com)

## **Responsibility of the manufacturer**

The following restrictions should be observed, as violation of the restrictions may cause cancellation of Struers legal obligations.

The manufacturer assumes no responsibility for errors in the text and/or illustrations in this manual. The information in this manual is subject to change without notice. The manual may mention accessories or parts not included in the supplied version of the equipment.

The manufacturer is to be considered responsible for effects on safety, reliability, and performance of the equipment only if the equipment is used, serviced, and maintained in accordance with the instructions for use.





# Declaration of Conformity

Manufacturer	Struers ApS • Pederstrupvej 84 • DK-2750 Ballerup • Denmark
Name	LaboPol-60
Model	LaboPol-60
Function	Grinding/Polishing machine
Type	06346127 In combination with: 06206901, 06356127, 06366127, 06386130, 06376902
Serial no.	



Module H, according to global approach

EU

We declare that the product mentioned is in conformity with the following legislation, directives and standards:

<b>2006/42/EC</b>	EN ISO 12100:2010, EN ISO 13849-1:2015, EN ISO 13849-2:2012, EN ISO 13850:2015, EN ISO 14120:2015, EN 60204-1:2006, EN 60204-1-A1:2009, EN 60204-1/Corr.:2010
<b>2011/65/EU</b>	EN 50581:2012
<b>2014/30/EU</b>	EN 61000-6-1:2007, EN 61000-6-3:2007, EN 61000-6-3-A1:2011, EN 61000-6-3-A1-AC:2012, EN 61000-3-2:2014, EN 61000-3-3:2013
<b>2014/35/EU</b>	
<b>Additional standards</b>	NFPA 79, FCC 47 CFR Part 15 Subpart B

Authorized to compile technical file/  
Authorized signatory

Enter release date:

Date: [Release date]

en For translations see  
bg За преводи вижте  
cs Překlady viz  
da Se oversættelser på  
de Übersetzungen finden Sie unter  
el Για μεταφράσεις, ανατρέξτε στη διεύθυνση  
es Para ver las traducciones consulte  
et Tõlked leiate aadressilt  
fi Katso käännökset osoitteesta  
fr Pour les traductions, voir  
hr Za prijevode idite na  
hu A fordítások itt érhetőek el  
it Per le traduzioni consultare  
ja 翻訳については、  
lt Vertimai patalpinti  
lv Tulkojumus skatīt  
nl Voor vertalingen zie  
no For oversettelser se  
pl Aby znaleźć tłumaczenia, sprawdź  
pt Consulte as traduções disponíveis em  
ro Pentru traduceri, consultați  
se För översättningar besök  
sk Preklady sú dostupné na stránke  
sl Za prevode si oglejte  
tr Çeviriler için bkz  
zh 翻译见

[www.struers.com/Library](http://www.struers.com/Library)