

Duramin-40

Instruction Manual



Manual No.: 16607001
Revision B

Date of Release 2017.11.28



Duramin-40
Instruction Manual

IMPORTANT

READ the instruction manual carefully before use.
Keep a copy of the manual in an easy-to-access place
for future reference.

Intended use:

The machine is intended to be used to test the hardness of metals according to the following methods:

Vickers	EN ISO 6507, ASTM E-384
Knoop	EN ISO 4545, ASTM E-384
Brinell	EN ISO 6506, ASTM E-10

The hardness tester meets the applicable DIN, ISO-EN, ASTM and JIS standards.

The machine is for use in a professional working environment (e.g. production floor or materialography laboratory).

The machine should only be used for its intended purpose and as detailed in the Instruction Manual.

The machine may only be operated by persons who have been properly trained in the operation, maintenance and repair of the machine and are aware of the risks involved. The manufacturer accepts no liability in cases where the machine is used for purposes other than those for which it is intended. In these cases, liability is transferred to the user.

Models:

Duramin-40 M1/M2/M3
Duramin-40 A1/A2/A3
Duramin-40 AC1/AC2/AC3

Duramin-40

Instruction Manual

Always state *Serial No* and *Voltage/frequency* if you have technical questions or when ordering spare parts. You will find the Serial No. and Voltage on the type plate of the machine itself. We may also need the *Date* and *Article No* of the manual. This information is found on the front cover.

The following restrictions should be observed, as violation of the restrictions may cause cancellation of Struers legal obligations:

Instruction Manuals: Struers Instruction Manual may only be used in connection with Struers equipment covered by the Instruction Manual.

Service Manuals: Struers Service Manual may only be used by a trained technician authorised by Struers. The Service Manual may only be used in connection with Struers equipment covered by the Service Manual.

Struers assumes no responsibility for errors in the manual text/illustrations. The information in this manual is subject to change without notice. The manual may mention accessories or parts not included in the present version of the equipment.

Original instructions. The contents of this manual are the property of Struers. Reproduction of any part of this manual without the written permission of Struers is not allowed.

All rights reserved. © Struers 2017.

Struers
Pederstrupvej 84
DK-2750 Ballerup
Denmark
Telephone +45 44 600 800
Fax +45 44 600 801



Duramin-40 Safety Precaution Sheet

To be read carefully before use

1. The operator(s) must read the Safety and User's Guide sections of this manual and the relevant sections of the manuals for any connected equipment and accessories.

WARNING!

Ignoring this information and mishandling of the equipment can lead to severe bodily injuries and material damage.

2. The machine must be installed in compliance with local safety regulations.
3. The machine must be placed on a safe and stable support. Failure to do so can affect the proper working and cause the equipment to fall down and/or cause accidents and injuries. All safety functions and guards of the machine must be in working order.
4. Do not modify this equipment. Doing so can cause fire and/or electric shock.
5. Do not twist or damage the power cords. Damaged power cords can cause fire and/or electric shock.
6. Do not disassemble this equipment. Doing so can cause electric shock.
7. Do not operate the equipment at a voltage other than the power voltage that is indicated. Doing so can cause fires.
8. Do not allow the machine to become wet. Fires can occur if water gets inside the equipment.
If water or other liquid does get inside the equipment, turn off the power to the equipment's main unit, disconnect the power supply, and call technical service.
9. If malfunctions, smoke or unusual noises are observed - turn off the power, disconnect the power supply and call technical service.
10. Do not connect/ disconnect power with wet hands. Doing so can result in electric shock.

Duramin-40
Instruction Manual

- 11.** Disconnect the power supply prior to any cleaning, maintenance or service.
Failure to do so can result in electric shock.
- 12.** Do not block the ventilation. Blocking the ventilation can cause heat to accumulate inside the instrument, which in turn, can generate fire.
- 13.** Do not open any panel on the machine.
High voltages exist inside the instrument and may cause electrical shocks to personnel.

The equipment should only be used for its intended purpose and as detailed in the Instruction Manual.

The equipment is designed for use with accessories supplied by Struers. If subjected to misuse, improper installation, alteration, neglect, accident or improper repair, Struers will accept no responsibility for damage(s) to the user or the equipment.

Dismantling of any part of the equipment, during service or repair, should always be performed by a qualified technician (electromechanical, electronic, mechanical, pneumatic, etc.)

Icons and typography

The following icons and typographic conventions are used in this instruction manual:

Icons and Safety Messages



ELECTRICAL HAZARD

indicates an electrical hazard which, if not avoided, will result in death or serious injury.



DANGER

indicates a hazard with a high level of risk which, if not avoided, will result in death or serious injury.



WARNING

indicates a hazard with a medium level of risk which, if not avoided, could result in death or serious injury.



CAUTION

indicates a hazard with a low level of risk which, if not avoided, could result in minor or moderate injury.



CRUSHING HAZARD

indicates a crushing hazard which, if not avoided, could result in minor, moderate or serious injury.

General Messages



Important or Note

indicates a risk of damage to property, or the need to proceed with special care.



Information or Tip

indicates additional information and tips.

Colour Inside Logo



The 'colour inside' logo on the cover page of this Instruction Manual indicates that it contains colours which are considered to be useful for the correct understanding of its contents. Users should therefore print this document using a colour printer.

Typographic conventions

Bold type	indicates button labels or menu options in software programs
<i>Italic type</i>	indicates product names, items in software programs or figure titles
■ Bullets	indicates a necessary work step

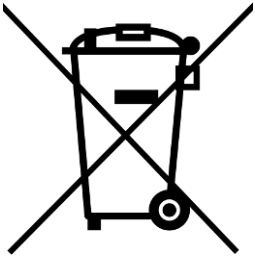

Disposal

Equipment marked with a WEEE symbol  contain electrical and electronic components and must not be disposed of as general waste.

Please contact your local authorities for information on the correct method of disposal in accordance with national legislation.

Duramin-40
Instruction Manual

User's Guide

Table of Contents	Page
1. Getting Started	
Unpacking Duramin-40.....	12
Location	13
Lifting Duramin-40.....	14
Placing Duramin-40.....	15
Levelling.....	15
Removing the Lifting Bar	15
Removing the Transport Plate.....	16
Checking the Contents	17
Getting Acquainted with Duramin-40.....	18
USB Drive and WiFi Adapter.....	20
Rear plate	20
Noise Level	20
Power Supply.....	21
Connecting the Tester	21
Assembling the Monitor.....	22
Connecting the Monitor	23
2. Basic Operations	
Front Panel Controls	24
Software.....	25
Start-up.....	25
Overview Screen.....	27
Main Menu	28
Test Result Window	28
Test Settings.....	28
Additional Results Window.....	28
Dashboard Controls	29
3. Maintenance	
General Cleaning	30
Daily Maintenance.....	30
Weekly Maintenance.....	30
Cleaning Surfaces.....	30
Weekly Inspection.....	30
Yearly Maintenance	31
Replacing the Fuse	31
Calibration.....	31

1. Getting Started

Unpacking Duramin-40

Important!

Refer to the **HOW TO UNPACK** instructions delivered with Duramin.

Take care whilst handling Duramin.
Do not expose to external impact.
Do not tilt over 30 degrees.
Do not touch the turret.

- Carefully open and remove the top of the packing crate.

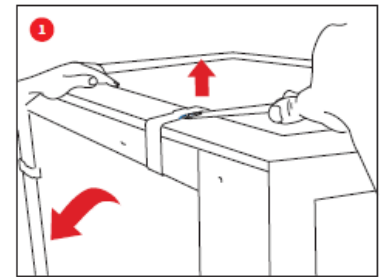

- Remove one side of the packing crate.
- Remove the monitor, box of accessories and other loose items.

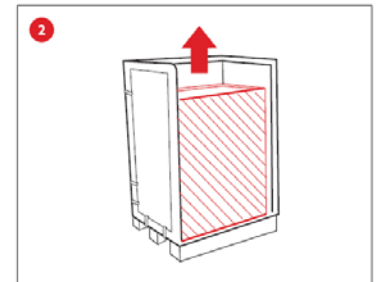

- Carefully lift the foam pieces to access Duramin.



NB: Store the packing box and foam packaging for use whenever Duramin is transported/re-located.

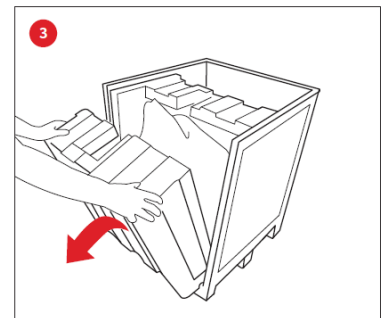

- Remove the plastic covering.

Location

- Duramin must be placed close to the power supply.
- Duramin is designed to be placed on a rigid, stable workbench with a horizontal surface.
The workbench must be able to carry at least 130 Kg / 280 lbs.

Minimum workbench dimensions:

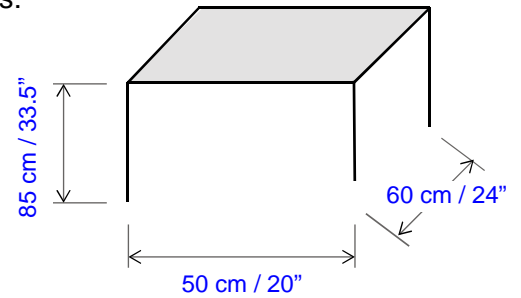

To take advantage of the maximum spindle capacity, a hole must be drilled in the table top to accommodate the full stroke of the spindle. Please refer to the *Drilling Plan* for dimensions.

Vibration-free Location

- Install Duramin in a vibration-free location.

Important!

Vibrations can lead to inaccurate measurements and must be avoided.

A simple way of detecting vibrations is to set up a tray of water and watch for ripples on the surface.



Sources of vibration can include:

- Passers-by (persons walking past), a road with heavy traffic, cranes, equipment generating vibrations, equipment generating sound (acoustic vibration), exposure to wind or air conditioning fans.

If possible, install the hardness tester on the ground floor of a building and away from exits or doorways.

Lifting Duramin-40

A crane and lifting straps are required to lift the machine from the packing box. The crane should have a minimum lifting capacity of 100 kg.



Important!

Take care whilst handling Duramin.
Do not expose to external impact.
Do not tilt over 30 degrees.
Do not touch the turret.

- Check that the crane has a free pathway from the lifting point to the final location.
- Place the lifting straps securely around the lifting bar.
- Carefully lift Duramin out of the packing box.

- Check whether the 4 adjustable vibration dampers are installed. If not,
 - Mount the dampers and adjust the height of the damper so that they are of equal height.
 - Place Duramin-40 into its final location

Placing Duramin-40 Levelling

To eliminate possible wear and tear of the tester's mechanical structure, the tester should be levelled once it is in its final location.

- Check that the XY-stage is level.

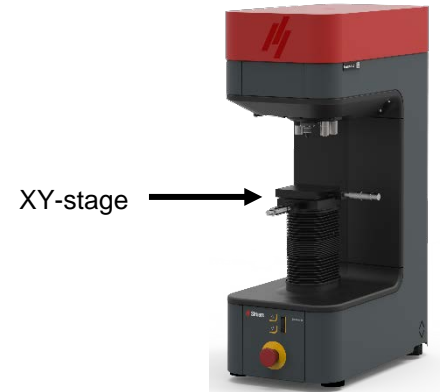

If not,

- Turn the vibration damper in the rear right hand corner, to level the XY-stage.



Removing the Lifting Bar

- Support the lifting bar and remove the screws and washers from both sides of the bar.

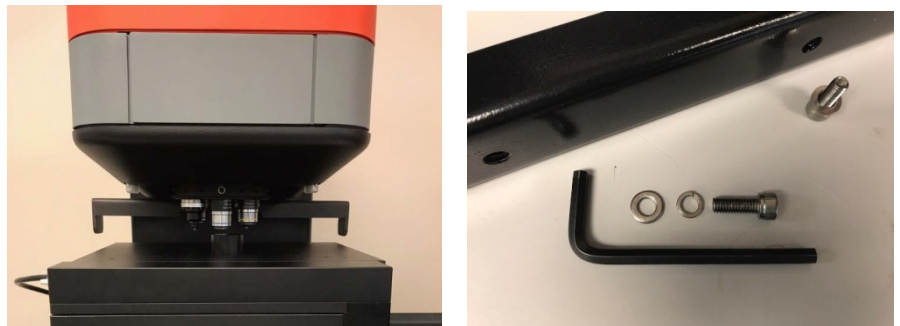

Important:
Keep the lifting bar, screws and washers for use whenever the machine is to be relocated.

Removing the Transport Plate
(Motorized XY-stage option only)

- Remove the transport safety **before** turning on the tester. The motorized XY-stage will automatically move to perform a reference search on initialization.



Important!
Damage to the stage will result if the tester is switched on with the transport safety plate mounted.

- Unscrew the six screws securing the transport safety plate at the rear.
- Keep the plate and screws for use whenever the machine is to be relocated.

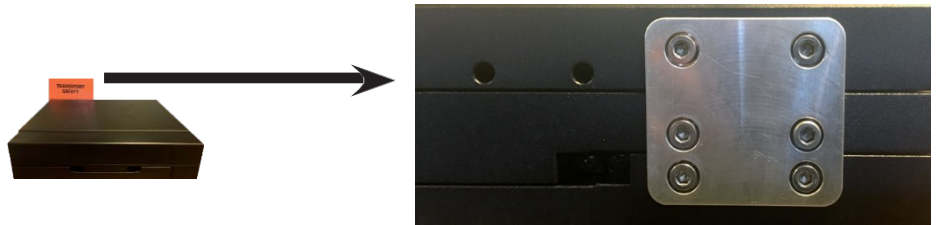

Checking the Contents

In the packing box you should find the following parts:

- 1 Duramin-40 (Hardness Tester)
- 1 Accessories Case
- 1 15" Monitor (2nd monitor optional)
- 1 Keyboard (Option)
- 1 Mouse (Option)

Accessories Case Standard Accessories



- Indenter(s) and objective lens(es)
- 1 Wireless Mouse and keyboard (Option)
- 2 Power cables
- 1 USB cable to monitor
- 1 HDMI to DVI cable
- 1 Spare fuse
- 1 Certificate of calibration on USB
- 1 USB Wi-Fi Adapter
- 1 Cables for motorized XY-stage (Option)
- 1 ASUS Bluetooth dongle (Option)

Optional Accessories

- Please consult your order confirmation to check that all the accessories ordered are included in the delivery.



Information:
Some components or parts may be packaged separately and may not be included in the accessory box or may have been installed on the hardness tester.



Information:
The actual packaging and accessories may appear different to those shown in the picture.

**Getting Acquainted
with Duramin-40**

Take a moment to familiarise yourself with the location and names of the Duramin-40 components.



15" LCD monitor
touchscreen

Tester

Wireless keyboard & mouse (Option)

Hardness Tester Body

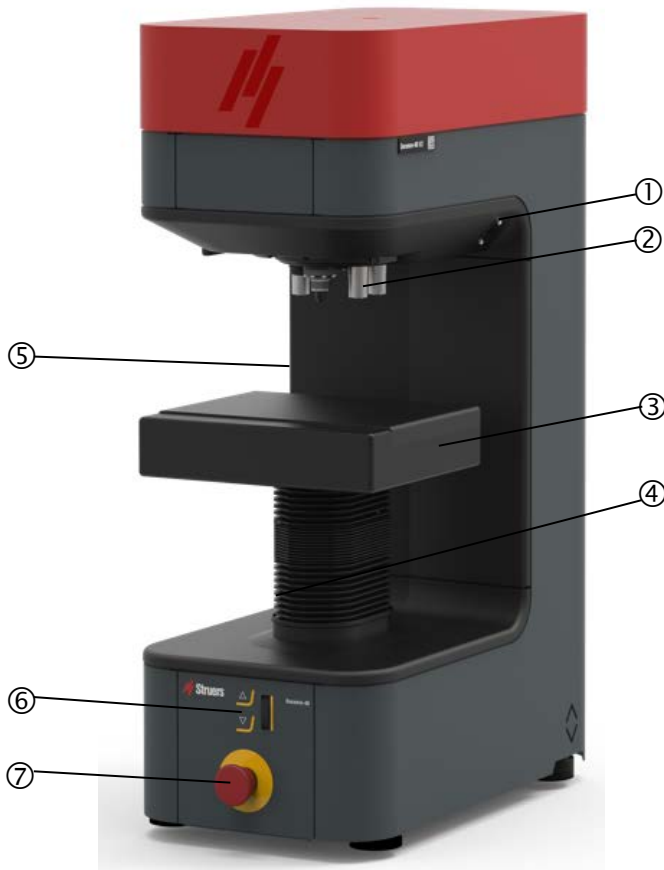

- ① USB port
- ② 6 position turret
- ③ XY-stage
- ④ Spindle cover
- ⑤ Connection for motorized XY-stage
- ⑥ Z-axis & focus control
- ⑦ Emergency stop

Power Connections

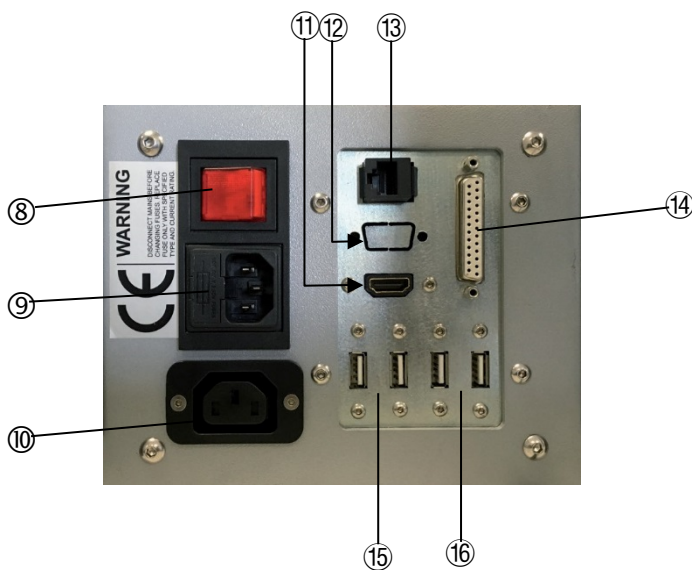

- ⑧ Main power switch
- ⑨ Main power connection / Fuse
- ⑩ Power connector to monitor
- ⑪ HDMI connector to monitor
- ⑫ Not used
- ⑬ Network (RJ-45 LAN connection)
- ⑭ Not used
- ⑮ USB to monitor
- ⑯ USB receiver for keyboard and mouse

USB Drive and WiFi Adapter



The USB drive contains direct and indirect calibration documents.



The USB WiFi Adapter allows for cable free communication with the Duramin.

Rear plate

Information on the model number, serial number, weight, date of manufacture, and power requirements can be found on the type plate on the back of the machine.

Noise Level

Less than 70¹ dB (A) measured at idle running, at a distance of 1.0 m/39.4" from the machine.

Use hearing protection if exposure to noise exceeds levels set by local regulations.

¹ "The figures quoted are emission levels and are not necessarily safe working levels. Whilst there is a correlation between the emission and exposure levels, this cannot be used reliably to determine whether or not further precautions are required. Factors that influence the actual level of exposure of the workforce include the characteristics of the workroom and the other sources of noise, i.e. the number of machines and other adjacent processes and the length of time for which an operator is exposed to the noise. Also, the permissible exposure level can vary from country to country. This information, however, will enable the user of the machine to make a better evaluation of the hazard and risk."
(ref. EN ISO 16089:2015)

Power Supply

Connecting the Tester

Always remember to switch the power off when installing electrical equipment!



ELECTRICAL HAZARD

- The machine must be earthed.
- Check that the mains voltage corresponds to the voltage stated on the type plate on the side of the machine. Incorrect voltage may result in damage to the electrical circuit.

Duramin-40 is shipped with 2 types of Mains cables:



The 2-pin (European Schuko) plug is for use on single-phase connections.

If the plug supplied on this cable is not approved in your country, then the plug must be replaced with an approved plug. The leads must be connected as follows:

Yellow/green: earth
Brown: line (live)
Blue: neutral

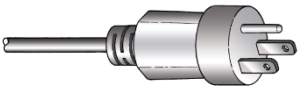

The 3-pin (North American NEMA 5-15P) plug is for use on single-phase connections.

If the plug supplied on this cable is not approved in your country, then the plug must be replaced with an approved plug. The leads must be connected as follows:

Green: earth
Black: line (live)
White: line (live)

Connection to the Machine



- Connect the power cable to the machine. (IEC 320 connector).
- Connect to the mains power supply.

Assembling the Monitor

Contents of the monitor box:

- 1 monitor with base
- 1 power cord adapter
- 1 USB cable, and European power cords.

Note: The dual monitor option will be delivered with 2 monitor boxes.

- Remove the monitor's rear panel.
- Slide the panel off to expose the connection ports.



- Remove the two black plastic pieces around the monitor stand joint.
- Adjust the stand angle.
If necessary loosen the two nuts around the joint using a 13 mm hexagonal wrench.



- Lay the monitor face down on a flat surface.
- Unscrew the four screws on the rear of the monitor.

- Position the stand on the back of the monitor and line up the four holes with the four screw holes.
Check that the label **TOP** will be at the top of the monitor when it is upright.
- Tighten the four screws to attach the monitor to the stand.

Connecting the Monitor

- Plug the USB cable into the USB port, HDMI cable to the DVI port, and the power cord adapter to the power port on the rear of the tester.
- Check that all plugs are connected correctly and replace the rear panel of the monitor.



Important!

Only monitors supplied by Struers may be connected to Duramin.
Failure to adhere to this may result in material damage.

Dual Monitor Option

The monitors will be labeled *Screen L* and *Screen R*.
The ports at the rear of the Duramin will also be labelled *Screen L* and *Screen R*.

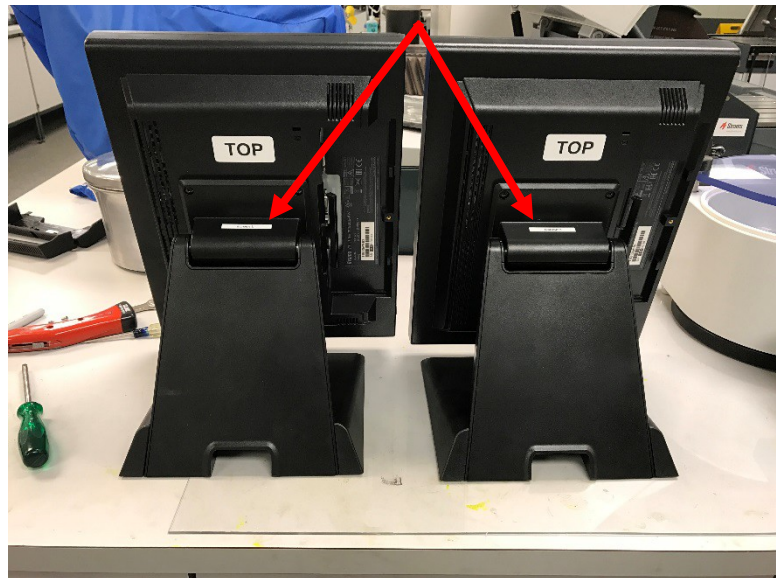

- Connect the correct USB and HDMI cables to the corresponding *Screen L* and *Screen R* ports.
- The power cable for the 2nd monitor must be plugged into a mains power socket.
The mains power socket must be easily accessible and located between 0.6 m - 1.9 m (2½" – 6') above floor level. (An upper limit of 1.7 m (5' 6") is recommended).

2. Basic Operations

Front Panel Controls



MAIN SWITCH

The main switch is located on the rear of the machine.
The main switch will be illuminated when the power is turned on.



The EMERGENCY STOP is located on the front of the machine.

Emergency Stop

- Push the red button to Activate.
- Turn the red button clockwise to Release.



NB!
BEFORE releasing (disengaging) the Emergency stop, investigate the reason for activating the Emergency stop and take any necessary corrective action.

Software

Duramin-40 is operated through the Duramin software. A short description of the software is included in this manual. Please refer to the Duramin software manual for a detailed description of the software functions.

Start-up

- Switch Duramin-40 on using the main switch at the rear. The Duramin software will initialize and the following progress bar will appear on the monitor:

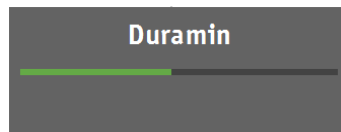

Tip:

Make sure that the emergency stop is not activated during start-up. If the emergency stop is activated during start-up, a failure message will appear.

- Release the emergency stop.
- Press **System**, then **Exit**.
- Switch Duramin Off using the Main switch, then switch on again to start initialization.

The following screen will appear on the monitor.

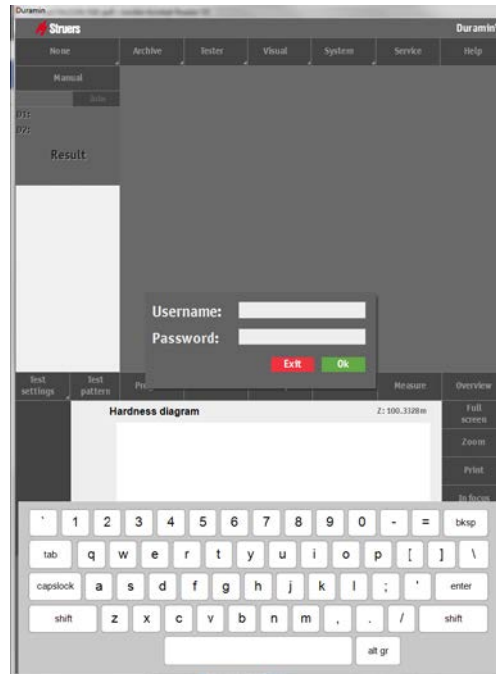

Note: The actual screen may appear different depending on the configuration and model of the Duramin-40.

- Push gently in the middle of the designated buttons for tester operation. Do not use force. Do not use sharp objects.

Alternatively, use the external keyboard and mouse to operate Duramin-40.

- Enter the *Username* and *Password*.
When Duramin is used for the first time, the default will be:
Username: Admin
Password: none
- Press **Ok**.



Tip: the default username is not case sensitive.

For instructions on how to add new users, please refer to the Software manual.

Overview Screen

The overview screen is primarily divided into 5 main areas.

- Main menu
- Test result
- Objective view
- Test settings with Additional results
- Dashboard Controls

The screenshot shows the Duramin software interface. On the left, arrows point to specific sections of the screen:

- Main Menu:** Points to the top navigation bar containing 'Vickers 1Kgf', 'Archive', 'Tester', 'Visual', 'System', 'Service', and 'Help'.
- Test result:** Points to the 'Results' section on the left, which displays 'D1: 0.0507 mm', 'D2: 0.0507 mm', and a large green box with '721.87 HV1'.
- Objective view:** Points to the central image area showing a diamond-shaped indentation on a metal surface.
- Test settings:** Points to the 'Test settings' button in the bottom control panel.
- Additional results:** Points to the 'Chd diagram' graph, which plots Hardness (Y-axis, 195 to 745) against Depth (mm) (X-axis, 0 to 4.4). The graph shows a red line with data points and a horizontal dashed line at HV 525. A label 'CHD 2.68' is visible on the graph.
- Dashboard Controls:** Points to the bottom control panel, which includes a rotary knob with '100X', '50X', '20X', and 'HK' markings, and a grid of directional and function buttons.

Duramin-40 Instruction Manual

Main Menu

The *Main Menu* is used to select the test method and scale required as well as adjusting settings and other functions.

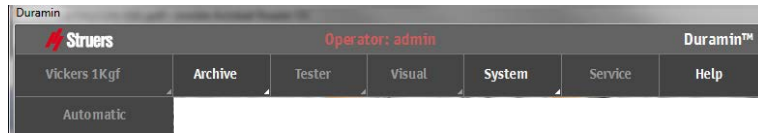

Test Result Window

The *Test Result Window* shows an image of the indent (or the indent pattern) and a list of the indents performed.

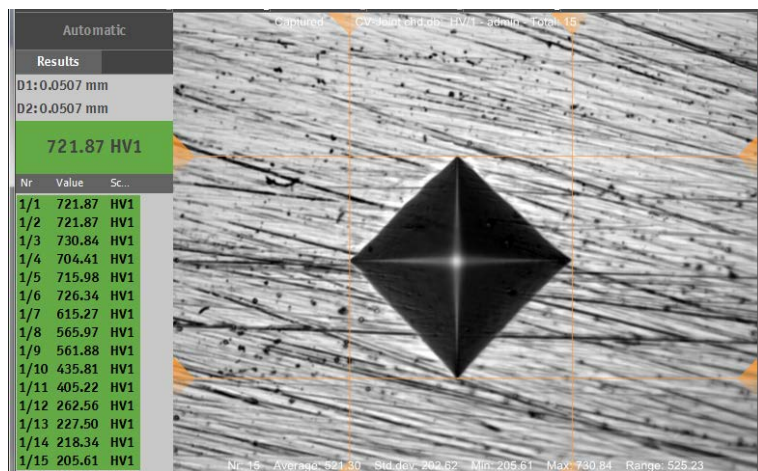

Test Settings

The *Test Settings* menus are used to select test patterns and to perform additional functions.

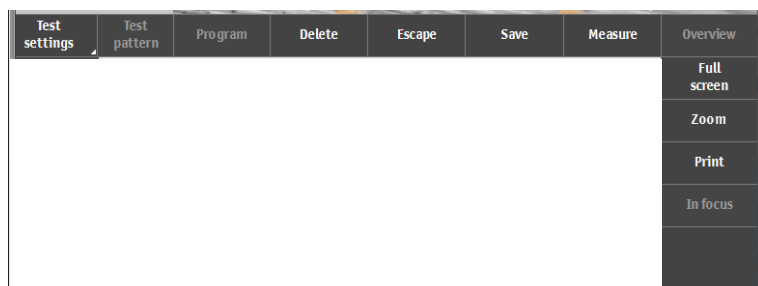

Additional Results Window

The *Additional Results Window* shows an illustration of the results obtained.

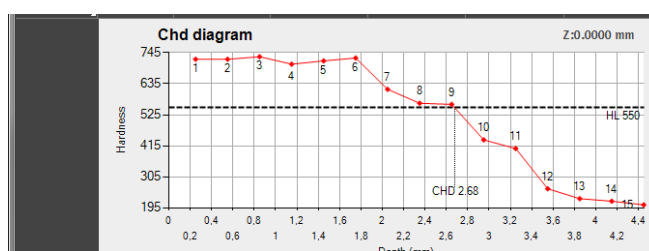

Dashboard Controls

The *Dashboard Controls* are used to move the turret and select the objective to be used, fine positioning of the spindle light controls and to start the indentation process.



Please refer to the [Duramin Software manual](#) for a detailed description of the software and its functions.

3. Maintenance

General Cleaning

- Keep Duramin-40 as clean as possible. To ensure a longer lifetime for your equipment Struers strongly recommends regular cleaning.

Daily Maintenance Machine



- Clean all accessible surfaces with a soft, damp cloth.

Tip:
Do not use a dry cloth as the surfaces are not scratch resistant.
Do not use aggressive or abrasive materials.
Grease and oil can be removed with ethanol or isopropanol.

IMPORTANT
Never use acetone, benzol or similar solvents.

Weekly Maintenance Cleaning Surfaces

- Clean painted surfaces and the control panel with a soft damp cloth and common household detergents.

Weekly Inspection

- Inspect the following parts before every hardness test or at least weekly.

Part	Attention	Action	Precaution
Indenter	Tip dirty	Wipe indenter	Do not bend the indenter shaft
Objective or lens	Lens surface polluted	Wipe lens	Do not scratch the objective or lens
Anvil	Rust	Remove rust	Do not bring the stage into contact with the turret.
Test block	Rusted	Replace test block	Do not use rusted test blocks

Yearly Maintenance

- Clean the elevator spindle and oil lightly with e.g. a universal household oil (do NOT lubricate the spindle with motor oil).
 - Carefully lift the spindle cover.
 - Wipe the spindle THOROUGHLY after lubrication so that as little as possible oil is left on the spindle.
 - Wipe the spindle again after a few days to ensure no oil residue is left on the spindle surface.

Replacing the Fuse

The fuse holder is located directly under the power connection on the rear of Duramin-40.

- Turn Duramin-40 off.
- Disconnect the electric power cable.

- Pull out the fuse holder using a flat-head screwdriver.
- Take out the blown fuse and replace with the reserve fuse.

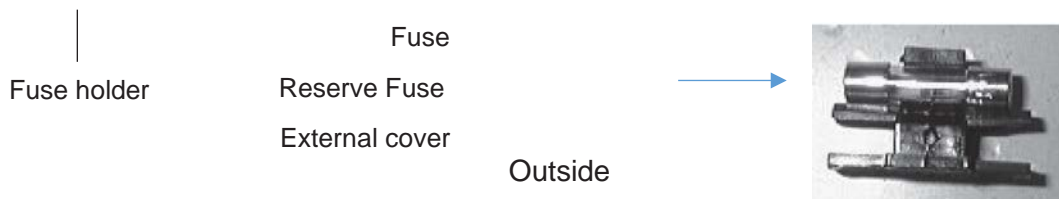

- Re-install the fuse holder.
- Re-connect the electric power cable.



Tip.
Remember to order a new reserve.

Calibration

Duramin-40's highly sensitive and accurate load cell and objectives are calibrated prior to shipping.

Please contact Struers Service should the load cell or objectives require recalibration.

Reference Guide

Table of Contents	Page
1. Struers Knowledge	33
2. Trouble-Shooting	34
3. Transport	35
4. Technical Data	36

1. Struers Knowledge

The need for fast, robust and well proven test methods for materials verification is inevitable. Vickers, Knoop, Rockwell and Brinell methods, with a countless number of loads and indenter geometries, gives an almost countless number of procedures, suitable for simple characterization of a large fraction of existing materials.



Visit the Struers Hardness testing website for a comprehensive introduction to the principles of hardness testing, useful troubleshooting tips and the latest application knowledge in the field.

Click on the link: [Struers - Ensuring Certainty / Knowledge / Hardness testing](#)

OR

Scan the QR code on the Duramin tag on your machine



2. Trouble-Shooting

Some of the minor malfunctions can be resolved by restarting the tester:

- Press **System**, then **Exit**.
- Switch Duramin Off, then switch on again to start initialization.

Error	Explanation	Action
Start-up failure	The emergency stop is activated	- Release the emergency stop. - Restart the tester.
Max down reached!	The maximum down position of the force actuator has been reached.	
Motor failure!	Failure of force application motor.	- Restart the tester. If the error remains, contact Struers Service.
System not initialized!	Failure of Software communication.	- Restart the tester. If the error remains, contact Struers Service.
Failed to open connection to AUX on EURP AUX Virtual Com Port (COM3)	Failure of Software communication.	- Restart the tester. - Press System , then Exit . - Switch Duramin Off, then switch on again to start initialization. If the error remains, contact Struers Service.
Load motor is not in home position		- Press Escape . - Then press Start . If this does not help, - Restart the tester. If the error remains, contact Struers Service.

3. Transport

DO NOT ship or transport the tester without the correct packing materials.

This could cause severe damage to the testers load application system.

- Keep the packing box and foam packaging for use whenever Duramin is transported/re-located.

DO NOT ship or transport the tester without mounting the lifting bar.
DO NOT ship or transport the tester without mounting the Transport Plate (motorized XY-stage option)

This could cause severe damage to the testers load application system.

- Keep the lifting bar, screws and washers for use whenever the machine is to be relocated.

4. Technical Data

Subject		Specifications
<i>Electrical Data</i>	Power supply	100 V AC – 240 V AC, 50/60Hz, single phase
	Power consumption (load)	82 W
<i>Residual Current Circuit Breaker</i>	Type A, 30 mA is required.	
<i>Weight</i>	Duramin-40 M1/M2/M3	101 Kg/ 223 lbs
	Duramin-40 A1/A2/A3	112 Kg/ 247 lbs
	Duramin-40 AC1/AC2/AC3	112 Kg/ 247 lbs
<i>Operating Environment</i>	Noise level	Less than 70 dB (A) measured at idle running, at a distance of 1.0 m/39.4" from the machine.
	Surrounding temperature	10-35 °C / 40-105 °F Recommended: 21 ±3 °C / °F
	Humidity	10%-90% RH (Non-condensing) Important No condensation may form on the test unit
<i>Safety standards</i>	Please refer to the Declaration of Conformity	



Please refer to the [Duramin-40 brochure](#) for further details.

English

Declaration of Conformity

Manufacturer

Struers ApS
 Pederstrupvej 84
 DK-2750 Ballerup, Denmark
 Telephone +45 44 600 800

Herewith declares that

<i>Name:</i>	Duramin-40
<i>Models:</i>	M1/M2/M3, A1/A2/A3, AC1/AC2/AC3
<i>Function:</i>	Hardness Tester
<i>Type No:</i>	660

fulfils all the relevant provisions of the:
**Machinery Directive
 2006/42/EC**

according to the following standard(s):
 EN ISO 12100:2010, EN ISO 13849-1:2008/AC:2009, EN ISO 13850:2008,
 EN 60204-1:2006/AC:2010.

and is in conformity with the:
**EMC Directive
 2014/30/EC**

according to the following standard(s):
 EN 55011:2009/A1:2010, EN61326-1:2013, EN 61000-3-2:2014,
 EN 61000-3-3:2013.

**RoHS Directive
 2011/65/EU**

according to the following standard(s):
 EN 50581:2012.

Supplementary Information

The equipment complies with the following standards:

The above has been declared according to the global approach, module A.

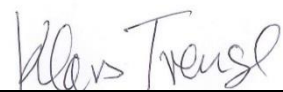
Authorized to compile the Technical File:

Klavs Tvenge
 Director of Business Development
 Struers ApS
 Pederstrupvej 84
 DK-2750 Ballerup, Denmark

Date of Issue: 2017.10.17



Pederstrupvej 84
DK-2750 Ballerup
Denmark