

SystemAbele

System for
Preparation of Thin Sections



Manual No.: SA05 7001

Date of Release 10.04.2014



SystemAbele

Instruction Manual

Always state *Serial No* and *Voltage/frequency* if you have technical questions or when ordering spare parts. You will find the *Serial No.* and *Voltage* on the type plate of the machine itself. We may also need the *Date* and *Article No* of the manual. This information is found on the front cover.

The following restrictions should be observed, as violation of the restrictions may cause cancellation of Struers legal obligations:

Instruction Manuals: Struers Instruction Manual may only be used in connection with Struers equipment covered by the Instruction Manual.

Service Manuals: Struers Service Manual may only be used by a trained technician authorised by Struers. The Service Manual may only be used in connection with Struers equipment covered by the Service Manual.

Struers assumes no responsibility for errors in the manual text/illustrations. The information in this manual is subject to change without notice. The manual may mention accessories or parts not included in the present version of the equipment.

Original Instructions. The contents of this manual are the property of Struers. Reproduction of any part of this manual without the written permission of Struers is not allowed.

All rights reserved. © Struers 2014

Struers A/S
Pederstrupvej 84
DK-2750 Ballerup
Denmark
Telephone +45 44 600 800
Fax +45 44 600 801



SystemAbele Safety Precaution Sheet

To be read carefully before use

1. The operator(s) should be fully instructed in the use of the equipment according to the Instruction Manual.

Bonding Jig

1. The Bonding Jig is made of solid metal and could cause an injury if dropped. The use of safety shoes is recommended.

UV Case

1. Keep the power supply away from water - Risk of death by electric shock!
 2. Do not bypass or deactivate the safety switch.
- Care! Risk of injury!**
3. Should one or more LEDs be switched on when the case is opened, then there is a defect. If this happens, immediately disconnect all electrical power.
DO NOT stare into the LEDs.
These emit a very strong UV light and can cause irreparable damage to the eyes.

Thin Section Mouse

- Care! Risk of injury!**
1. The brass button of the Thin Section Mouse is tensioned by a strong spring and is held in place by the black cap. Improper operation can result in the brass button being ejected at great force and cause damage.
Never point the brass button at your eyes or those of others!

The equipment should only be used for its intended purpose and as detailed in the Instruction Manual.

The equipment is designed for use with consumables supplied by Struers. If subjected to misuse, improper installation, alteration, neglect, accident or improper repair, Struers will accept no responsibility for damage(s) to the user or the equipment.

Dismantling of any part of the equipment, during service or repair, should always be performed by a qualified technician (electromechanical, electronic, mechanical, pneumatic, etc.)

SystemAbele
Instruction Manual

Table of Contents	Page
1. Bonding the Specimen	
The SystemAbele Bonding Jig	2
Placing Bonding Jig in a Heating Cabinet or Desiccator	3
Before Use	3
Using the Bonding Jig	4
2. The UV Case	
Controls top.....	5
Controls bottom.....	5
Adjusting the Process Time.....	6
Operation of UV Case	6
3. Preparing the Thin Section Mouse	7
Attaching the Glass Slide	8
Preparing the Setting Device.....	8
Setting the Thin Section Mouse.....	9
Preparing the Setting Device:.....	9
Setting the Thickness for Grinding:	9
4. Grinding with the Thin Section Mouse	
Mounting the LaboPol Adapter Kit.....	10
Using LaboPol for Grinding with the Thin Section Mouse	11
Re.mounting the Magnetic Disc.....	11
Adjusting the Height of the Mouse Guide	12
Grinding with the Thin Section Mouse	13
Measurement During Grinding	15
Zero the Gauge:.....	15
Measuring Thickness:	15
Reading the Gauge:.....	15
5. Polishing	
Using the Polishing Tool.....	17
6. Maintenance and Cleaning of the Thin Section Mouse	18
Re-inserting the Pump Piston Assembly	19

1. Bonding the Specimen

The SystemAbele Bonding Jig

Two models of Bonding Jig are available:
Bonding Jig
Bonding Jig UV

The basic function of the models is the same, with pressure being applied to minimise the thickness of the layer of bonding resin (approximately 5µm).

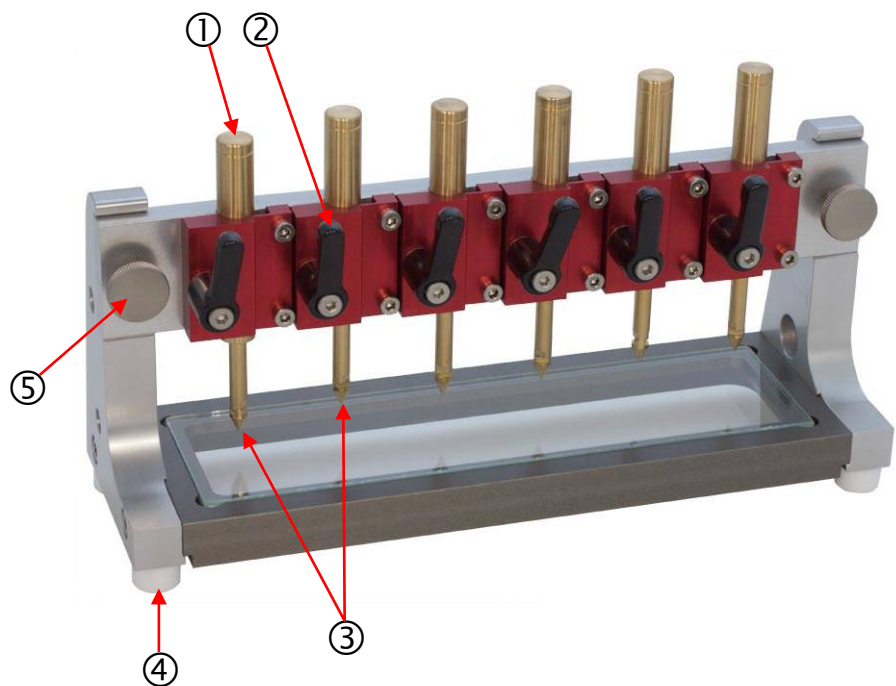

- ① Pressing rod
- ② Clamping Lever
- ③ Pressure tip (replaceable)
- ④ Feet
- ⑤ Knurled screw for traverse

Bonding Jig

Has a solid table.

If heat is required to cure the bonding resin:

- Unscrew the feet from the bonding jig and place on a hotplate.

Bonding Jig UV

Has a table with a hole for either an Aluminium plate or a glass window.

The glass window is used when UV light is required to cure the bonding resin.

Placing Bonding Jig in a Heating Cabinet or Desiccator

Both models can be used in a heating cabinet, or in a large desiccator.

Resins

EpoSpeed S is soluble in acetone and dissolves with the application of heat
EpoSpeed 20 provides a permanent bond

Tip: Wipe up any EpoSpeed 20 spilled on the plate, BEFORE activating with UV light, otherwise it will be very difficult to remove.

Tip:

If making a Thin section with powdered material, make sure that the layer is not too thick, otherwise the UV light won't go through and the resin will not cure properly.

Spike Pads

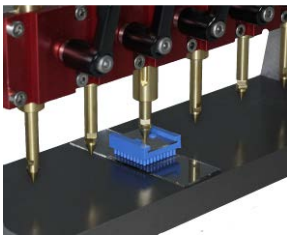

A Spike Pad can be used to distribute the pressure evenly when bonding thin, filigree or flexible specimens or bonding coverslips.

- Place the Spike Pad over the centre of the specimen.
- Guide the end of the pressure tip into the small hole on the back of the Spike Pad.

Before Use

Before using the Bonding Jig for the first time:

- Lubricate the surfaces with a thin application of a suitable release agent, e.g. silicone oil, Vaseline or wax. The surface of the table can also be lightly lubricated.



Before using a Spike pad:

- Moisten some soap and gently rub the spike pad on the soap.

Using the Bonding Jig



- Apply a thin layer of resin to the specimen, place on the glass slide and press firmly together.
- Place the glass slide on the table of the Bonding Jig.
- Hold the pressure tip and open the Clamping Lever by turning the black lever clockwise.
- Allow the tip to move down onto the specimen.
If extra pressure is required, press on the tip until the required pressure is achieved then lock the Clamping Lever.
When bonding cover slides, the weight of the pressure tip should be enough.

Tip: For best results, use 28 x 48 mm glass slides for producing thin sections

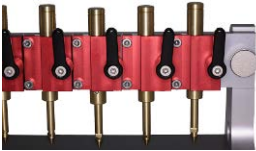

Tip: If there is not enough space to turn the lever, pull the black handle, turn it clockwise or counter clockwise then release. Ideally, all clamping levers should point upwards.

2. The UV Case

Controls top

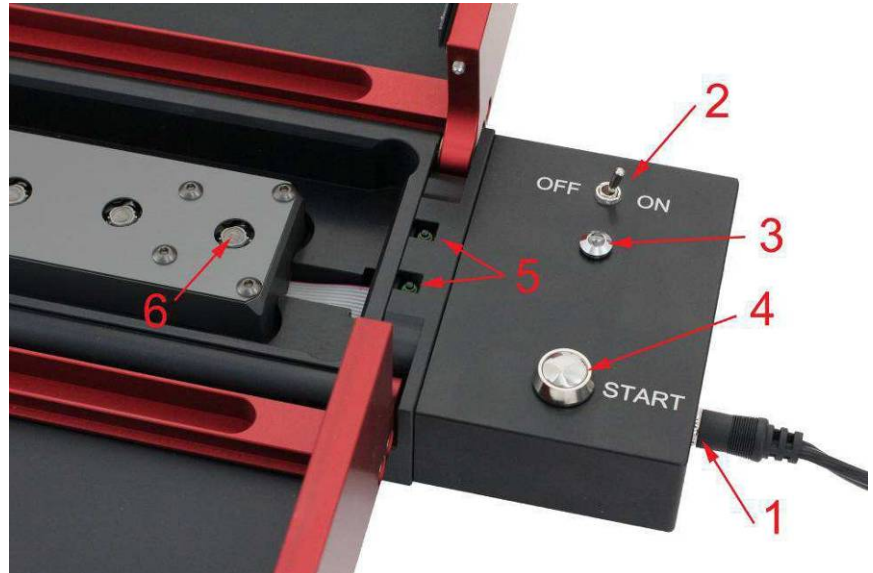

- 1 - 5V DC connector
- 2 - Main switch
- 3 - Status display
- 4 - Start Button
- 5 - Safety switch
- 6 - LED

Controls bottom

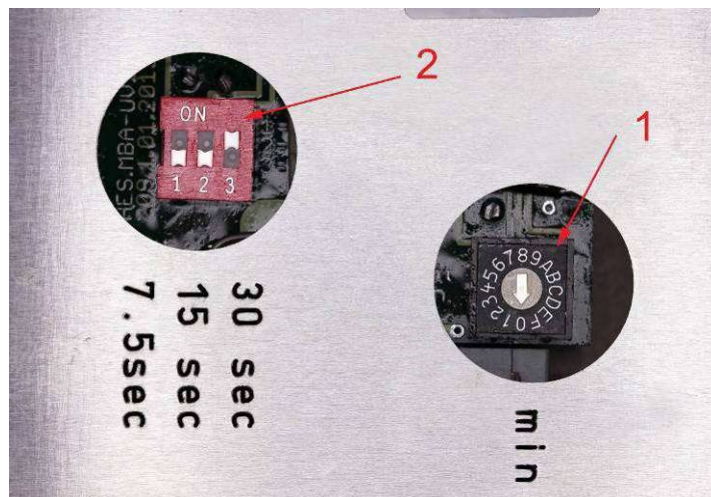

Default setting: 0 minutes and 30 seconds

- 1 - Rotary switch - for full minutes
- 2 - Triple Slide switch - for seconds

Adjusting the Process Time

Place the UV Case on its side on a clean, soft surface. There are two openings in the bottom of the control box to access the switches for setting the process time. The values of both switches add up to a total process time.

Rotary switch: Use a small flat screwdriver to set the number of full minutes, from 0 to 15.

Triple slide switch: Set the seconds by sliding the switches ON or OFF.

The switches have the following values:

Switch 1 = 7.5 seconds

Switch 2 = 15 seconds

Switch 3 = 30 seconds.

Setting table for the slide switch:

S 1	S 2	S 3	Seconds
OFF	OFF	OFF	0.0
ON	OFF	OFF	7.5
OFF	ON	OFF	15.0
ON	ON	OFF	22.5
OFF	OFF	ON	30.0
ON	OFF	ON	37.5
OFF	ON	ON	45.0
ON	ON	ON	52.5

Operation of UV Case

- Check that the preset time is correct for your UV adhesive. Adjust if necessary.
- Prepare your specimens on the Bonding Jig UV or on the UV Table.
Make sure that the Pressing rod of unused stations of the Bonding Jig UV are not too high, otherwise the housing of the UV Case will not close.
- Set the Bonding Jig UV or the UV Table in the UV Case.
- Close the case.
- Set the main switch to "ON".
The status indicator lights up - green
- Press "START".
The status indicator flashes green / orange.
- The end of the set time is indicated by a beep.
- Open the UV Case and remove the Bonding Jig UV or UV Table.

3. Preparing the Thin Section Mouse



The Thin Section Mouse is delivered with the following parts:

- 1 Thin Section Mouse
Manual holder for grinding of thin sections
- 2 Fork wrenches for maintenance
- 4 Spare adjustment feet
- 1 Allen key 2.5mm for adjustment feet
- 1 Grease
- 2 Spare sealing-rings

The Thin Section Mouse

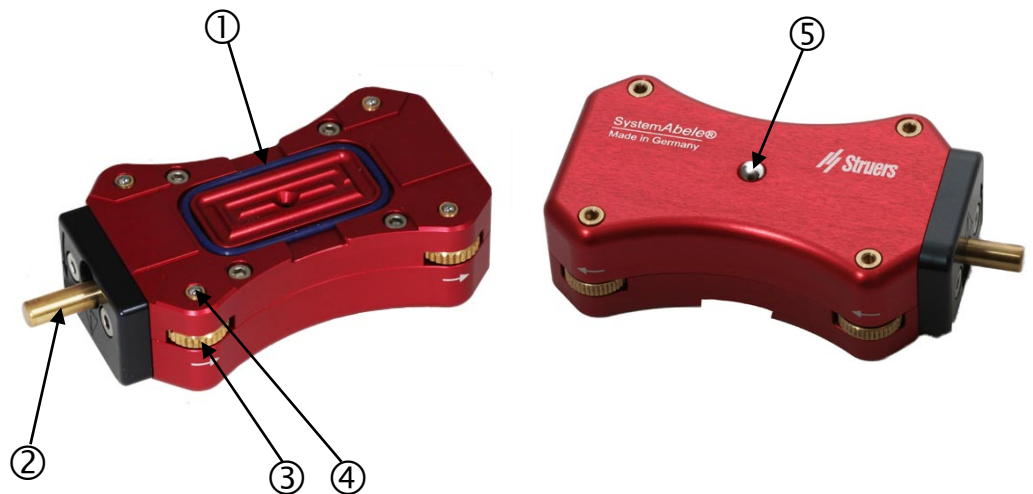

- ① Seal
- ② Brass button
- ③ Adjustable feet
- ④ Lock nuts
- ⑤ Pressure Ball

- Insert the blue sealing ring into the corresponding groove on the bottom of the Thin Section Mouse.
If it pops out again, twist it slightly between your fingers and insert it again.

Always use seal supplied by Struers A/S.
Other seals are not soft enough and will not perform correctly.

Attaching the Glass Slide



- Wet the area around the sealing ring by adding water or by holding the Thin Section Mouse under running water.
- Turn the thin section with mouse upside down and insert the glass slide into the recess provided.
- Place a finger on the glass slide and move it in every direction to ensure that it lies completely flat and centered on the sealing-ring. If the edge of the glass slide is on the sealing-ring, the suction force of the vacuum pump may be released.
- Press the brass button in all the way and then release. Repeat 5-6 times to ensure a good vacuum is achieved. The glass slide will be firmly drawn against the underside of the Thin Section Mouse.

Preparing the Setting Device

The Setting Device is delivered with two sets of metal distance sheets from 30 μ to 1000 μ (2 distance sheets per thickness).

- Place the metal distance sheets on the retaining pins on the rear of the Setting Device.

TIP!

Pay attention to cleanliness!
Dirt under or on the metal distance sheets would result in incorrect thickness setting.



Setting the Thin Section Mouse

Preparing the Setting Device:

- Select a metal distance sheet of the desired specimen thickness and place on the retaining rings at the front of the Setting Device on each side of the opening.
A combination of distance sheets can be used, but the thickness of the distance sheets should be identical on each side.
- Loosen the 4 brass lock nuts of the Thin Section Mouse.
- Turn the feet adjustment screws using the Allen key 2,5 mm.
Turn the screws counter clockwise to lift the feet until they are approximately level with the bottom of the Thin Section Mouse

Setting the Thickness for Grinding:

- Place the Thin Section Mouse in the Setting Device.
The centre of the pressure screw is directly over the pressure ball on the Thin Section Mouse.

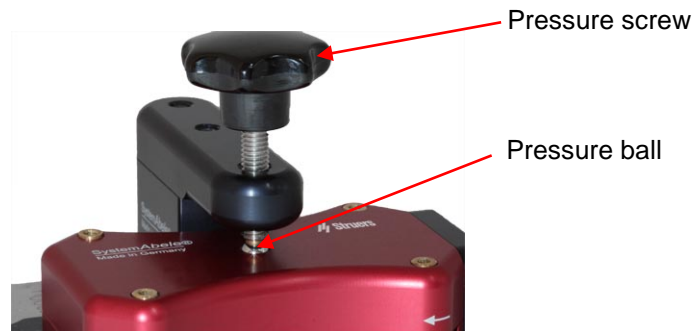

The Thin Section Mouse fits tightly into the Setting Device, making positioning easier.

- The glass slide rests on the right and left metal distance sheet. (See picture).
Fix this position by turning the pressure screw, tighten carefully and moderately.
- Open the lock nut so that the adjustment screws turn freely.
- Carefully turn the adjustment screws clockwise to lower the feet, one after the other on either side of the metal distance sheets. Lower the feet until you can feel a slight resistance as the feet come into contact with the Setting Device.
Tip – when this position is reached, slightly raise the feet then lower again, to check that they are positioned correctly.
- When the feet are in the desired position, fix them in place by turning the lock nut in the direction of the arrow. Tighten the lock nut firmly to make sure that the feet are kept in position.

The feet now extend to the desired thickness; the Thin Section mouse is ready.

4. Grinding with the Thin Section Mouse

Mounting the LaboPol Adapter Kit

The kit consists of:

- 1 Rinsing device
- 1 SystemAbele Turntable
- 1 Replacement Body for Water Tap
- 1 Allen key
- 1 Fork wrench
- 1 Nozzle tip
- 1 Adapter ring for Struers discs
- 1 Silicone lubricant
- 2 Washers 1mm and 0.5 mm
- 3 Bolts



- Disconnect the power supply and switch off the water supply.
- Remove the splash guard.
(if a LaboForce is mounted, lift the LaboForce head).
- Lift the magnetic disc off the turntable.
- Unscrew the three bolts on the turntable and remove.



- Fully open the water tap
- Unscrew the valve insert with the wrench supplied



- Remove the water tap body.
- Grease the water valve and the inside of the SystemAbele tap body with silicone grease.
- Mount the SystemAbele water tap body.



- Replace the valve insert and tighten with the wrench supplied.
- Close the water tap.
- Mount the SystemAbele turntable and secure in place with the three bolts.

*Using LaboPol for Grinding with
the Thin Section Mouse*



- Mount a SystemAbele grinding disc on the turntable.
- Position the rinsing device above the disc. The rinsing device will slot into the grooves in the LaboPol.



- Remove the short nozzle from the tap and connect the tube on the rinsing device.

Re.mounting the Magnetic Disc



LaboPol with a SystemAbele turntable can be adapted for grinding and polishing as a standard LaboPol.

- Insert the Adapter ring into the recess in the bottom of the magnetic disc.
- Push firmly to secure in place.

Adjusting the Height of the Mouse Guide



The height between the Teflon mouse guide and the grinding disc should be checked. The height should be between 0.5 and 1.5 mm.

- Slide the 0.5 mm washer between the guide and the grinding disc.
- Holding the 0.5 mm and 1 mm washers together, check that they are NOT able to fit under the guide.
- If required, adjust the height of the guide by inserting the washers between the rinsing plate and the guide

Grinding with the Thin Section Mouse

- Switch LaboPol on.
- Switch the water supply on.
- Open the water tap.
Adjust the flow of water so that it runs freely on the disc.
It is important that the flow is enough to rinse the resulting swarf/
debris produced during grinding away from the disc.
If the flow of water is limited, there is a risk of damaging the disc.

Tip: Carefully lift the edge of the rinsing device to check that there is a good flow of water from all 6 jets.

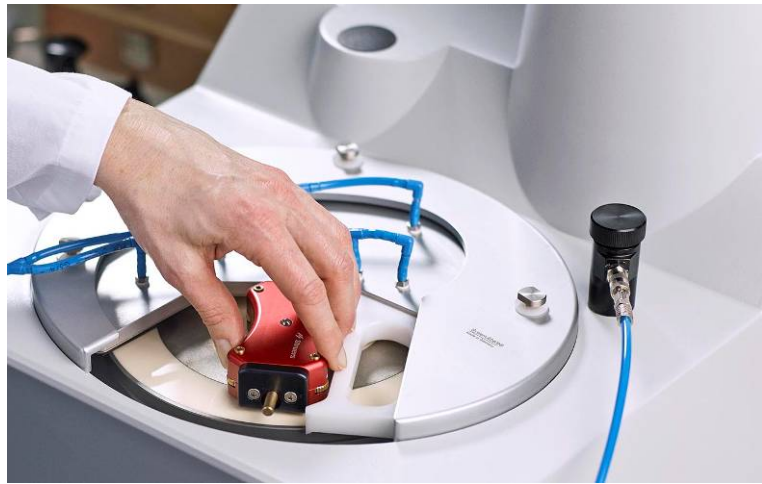

- Place the Thin Section Mouse on the grinding disc with the brass button of the vacuum pump pointing away from the LaboPol. Hold the Thin Section Mouse horizontally - Make sure that the feet of the Thin Section Mouse are on the smooth surfaces of the grinding disc and **DO NOT TOUCH** the abrasive surfaces.
- Place the right side of the mouse against the guide, so that the rotation moment will hold it against the guide and reduce the risk of the feet being dragged into contact with the grinding surface. The Thin Section Mouse must **ALWAYS** be in **FULL CONTACT** with the guide. The feet will be damaged if they come into contact with the grinding surface.
- Press Start and set the desired speed.
- Carefully move the Thin Section Mouse back and forth along the guide. Use a light pressure by pressing downwards on the mouse.
- Adjust the speed to increase/ decrease the grinding rate.
At higher speed, grinding will be quicker, but there may be a risk of damaging the specimen. The optimal grinding rate will depend on the type and thickness of the specimen.
During grinding, check that the rinsing water from the bowl is drained off, and that the drain hose is not blocked.

Tip: To avoid losing specimens by overgrinding due to incorrect settings or other errors, regularly check the thickness of the specimen using a measurement gauge.
See the following section [Measurement During Grinding](#) for details.

Tip: The grinding noise will change when the grinding process is complete. (An experienced user will also be able to feel the change as the feet of the mouse slip on the smooth surfaces of the grinding disc.)
Stop grinding immediately, to reduce unnecessary wear on the grinding disc.

Measurement During Grinding

Zero the Gauge:

Before carrying out measurements, you need "zero" the gauge:

- Place the gauge on a plane surface (e.g. the smooth surface of a grinding disc) and press gently.
- If the gauge does not read zero, turn the scale until it reads Zero.

Measuring Thickness:



- Set the gauge on the slide with a specimen mounted, with the three balls resting on the glass. The thickness of the specimen can be read on the scale. The measurement range is 1 mm.

Reading the Gauge:

The big hand points to the outer scale, each graduation corresponds to 1 μm .

A half revolution corresponds to 100 microns = 0.1 mm, one complete revolution will be 200 microns = 0.2 mm.

The small hand points to the inner scale, graduation corresponds to 100 microns = 0.1 mm.

Read the large scale and then the small scale, then add the readings together. See the examples on the next page.

Examples:



Big hand pointing to 56, small hand pointing to between 0.1 and 0.2

Thus: $56 \mu\text{m} + 100 \mu\text{m} = 156 \mu\text{m}$



Big hand pointing to 39, small hand pointing to just over 0.

Thus: $39 \mu\text{m} + 0 \mu\text{m} = 39 \mu\text{m}$



Big hand pointing to 31, small hand pointing to above 0.5.

Thus: $31 \mu\text{m} + 500 \mu\text{m} = 531 \mu\text{m}$

5. Polishing

Using the Polishing Tool

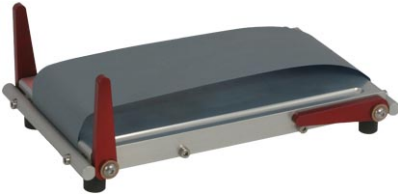

- Open the levers of the Polishing tool.
- Select the required abrasive/ polishing paper and insert into the Polishing tool.
- Secure the paper in place by closing the levers.
- Wet the recess in the bottom of the Polishing Mouse.
- Place the glass slide with specimen into the recess.
- Wet the abrasive/ polishing paper with a small amount of ethanol or water.
- Polish the specimen by moving the Polishing mouse in a *figure 8* pattern.
Hold the mouse on the polishing paper by placing a finger on the top, but take care not to apply too much pressure to the top of the Polishing mouse.

6. Maintenance and Cleaning of the Thin Section Mouse

Care! Risk of injury!

The brass button is tensioned by a strong spring and is held in place by the black cap. Improper operation can result in the brass button being ejected at great force and cause damage.

Never point the brass button at your eyes or those of others!



With the arrows on the black lid pointing towards you:

- Loosen the screw on the right using 3 mm Allen key size 3 mm – a ¼ turn will be enough.
DO NOT REMOVE!



- Hold the black lid firmly in place so that it does not move and remove the screw on the left using a 3 mm Allen key.



- Press the brass button slightly in and hold firmly.
- Twist the black cap in the direction of the curved arrow until the body of the brass button is free.
- CAREFULLY release the brass button until there is no tension in the spring.

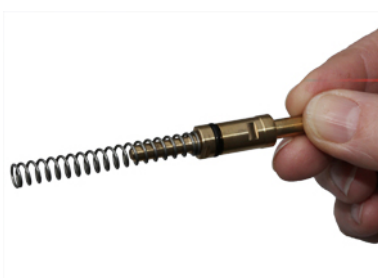

- Clean the pump piston assembly thoroughly with warm water and detergent, use an ultrasound bath if available.
- Dry all parts and lubricate the O-ring and spring with silicone grease.



If necessary, change the O-ring:

- Unscrew the front part of the pump piston assembly using the two fork wrenches supplied.

Fork wrenches →



O-ring →

Brass button →

Pump piston →

Spring →

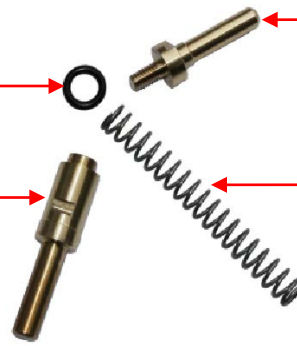

Re-inserting the Pump Piston Assembly

- Insert the pump piston assembly through the hole in the black lid.
- Push the brass button and turn the lid so that the pump piston is held in position.
- Re-insert the screw.
- Tighten both screws.

7. Spare Parts

	Part Name	Part No.
Thin Section Mouse	Spare feet carbide, 4 pcs.	SA052180
	Spare feet ceramic, 4 pcs.....	SA052182
	O-ring replacement set for format 28 x 48	
	O-ring 6x2, 1 pc	
	O-ring 35x2, 2 pcs	
	Silicon grease, 6g.....	SA052184
	O-ring replacement set for format 26 x 76	
	O-ring 6x2, 1 pc	
	O-ring 52x2, 2 pcs.	
	Silicon grease, 6g.....	SA052186
Bonding Jig UV	Windows, 2 pcs.....	SA051185
UV Table	Windows, 2 pcs.....	SA051185
UV Case	LED body 365nm / 400nm	
	Body of aluminium, complete with electronic parts, adjusted for the LEDs and 3 + 3 LEDs	SA051380
	LED body 365nm	
	Body of aluminium, complete with electronic parts, adjusted for the LEDs and 6 LEDs 365nm.....	SA051382
	LED body 400nm	
	Body of aluminium, complete with electronic parts, adjusted for the LEDs and 6 LEDs 400nm.....	SA051384
Control card		
Control card complete with start button, LED and on/off switch and 2 micro switches	SA051386	
Setting Device 28 x 48	Set of distance sheets 28 x 48 2 pcs. each: 1000µm, 300µm, 100µm, 50µm, 30µm.....	SA052380
Setting Device 26 x 76	Set of distance sheets 26 x 76 2 pcs. each: 1000µm, 300µm, 100µm, 50µm, 30µm.....	SA052381
LaboPol adapter kit	Set of wipers (9pcs.)	SA052205
	Water Tube, Ø 5x3 mm, 2m	SA052206

CE EC Declaration of conformity

as defined in the EC Directive on machines 2006/42/EC, attachment II 1A

The machinery
Product: Case for curing of UV Resins Models: UV Case Serial numbers: 001 to 999
has been developed, constructed and produced by:
mba Abele GmbH Nägeleshofstr. 80 73434 Aalen Deutschland
in accordance with the following EC directives:
<ul style="list-style-type: none">• Machinery directive (2006/42/EC)• Low voltage directive (2006/95/EC)• EMC Directive (2004/108/EC)

The following harmonised standards have been consulted:
<ul style="list-style-type: none">• EN ISO 12100-Safety of machinery - General principles for design - Risk assessment and risk reduction• EN 60204-1- Electrical equipment of machines - Part 1: General requirements• EN ISO 13849-1- Safety-related parts of control systems - Part 1: General principles for design

Documentation authorised person:
Georg Abele mba Abele GmbH

Aalen, 01.04.2014



.....
Georg Abele
(Managing Director)



Pederstrupvej 84
DK-2750 Ballerup
Denmark